

**WT2030**  
**Digital Power Meter**

**U S E R ' S M A N U A L**

---

---

## Foreword

Thank you for purchasing the YOKOGAWA Model WT2030 Digital Power Meter. This User's Manual contains useful information regarding the instrument's functions and operating procedures as well as precautions that should be observed during use. To ensure proper use of the instrument, please read this manual thoroughly before operating it. Keep the manual in a safe place for quick reference whenever a question arises.

## Notes

- The contents of this manual are subject to change without prior notice.
- Every effort has been made in the preparation of this manual to ensure the accuracy of its contents. However, should you have any questions or find any errors, please contact your dealer or YOKOGAWA sales office.
- Copying or reproduction of all or any part of the contents of this manual without YOKOGAWA's permission is strictly prohibited.
- The guarantee certificate is attached to the packaging container. Since it will not be reissued, it should be kept in a safe place after it has been read.

## Trademarks

- MS-DOS is a registered trademark of Microsoft Corporation.
- Company and product names used in this manual are their trade marks or registered trademarks.

## Revisions

1st Edition: August 1996

2nd Edition: March 1997

3rd Edition: April 1998

# Checking Package Contents

Unpack the box and check the contents before operating the instrument. If the wrong instrument or accessories have been delivered, if some accessories are missing or if they appear abnormal, contact the dealer from which you purchased them.

## WT2030 Main Body

Check that the model name and suffix code given on the name plate of the rear panel match those on your order.

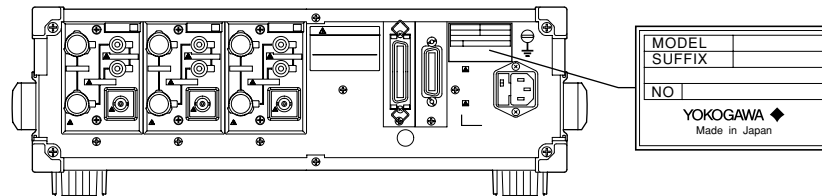

## MODEL

| Logo   | Model  | Basic Specifications  |
|--------|--------|---|
| WT2030 | 253102 | WT2030 253102 Capable of measurement for single-phase, two-wire; single-phase, three-wire; and three-phase, three-wire systems.   |
| WT2030 | 253103 | WT2030 253103 Capable of measurement for single-phase, two-wire; single-phase, three-wire; three-phase, three-wire; three-phase, four-wire; and three-voltage, three-current systems. |

## SUFFIX

| Suffix Code | Description                             |
|-------------|---|
| - C1        | GP-IB interface                         |
| - C2        | RS-232-C interface                      |
| - 1         | Rated AC line voltage: 100 VAC          |
| - 3         | Rated AC line voltage: 115 VAC          |
| - 5         | Rated AC line voltage: 200 VAC          |
| - 7         | Rated AC line voltage: 230 VAC          |
| - D         | UL/CSA standard power cord              |
| - F         | VDE standard power cord                 |
| - R         | SAA standard power cord                 |
| - J         | BS standard power cord                  |
| /B5         | Printer incorporated                    |
| /HRM        | Harmonic analysis function incorporated |
| /DA         | D/A outputs (14 channels)               |
| /FL         | Flicker Measurement Functions           |

## NO

When contacting the dealer, please give this serial number.

### Standard Accessories

The following standard accessories are supplied with the instrument.

| No. | Name  | Part No.                  | Quantity | Remarks                                       |
|-----|---|---------------------------|----------|---|
| 1   | Power cord                                  | Refer to the suffix code. | 1        | Type of cord is specified by the suffix code. |
| 2   | Spare fuse<br>(supplied in the fuse holder) | A1353EF                   | 1        | 100 VAC/200 VAC common<br>(250 V, 5 A)        |
| 3   | External shunt connector cable              | B9284LK                   | 2 or 3   | 1 for each element                            |
| 4   | Remote control connector                    | A1005JD                   | 1        | External input and output                     |
| 5   | Roll chart                                  | B9293UA                   | 2        | Built-in printer (optional),<br>58 mm × 10 m  |
| 6   | Rubber feet                                 | A9088ZM                   | 1        | 1 pair  |
| 7   | User's Manual                               | IM253102-01E              | 1        | This manual                                   |

1 (One of these codes is supplied according to the suffix code.)

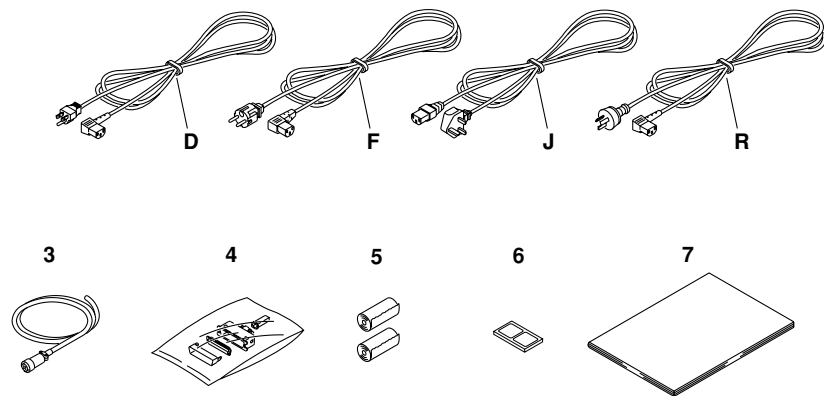

#### Note









- It is recommended that the packing box be kept in a safe place. The box can be used when you need to transport the instrument somewhere.

# Safety Precautions

This instrument is an IEC safety class I instrument (provided with terminal for protective grounding).

The following general safety precautions must be observed during all phases of operation, service and repair of this instrument. If this instrument is used in a manner not specified in this manual, the protection provided by this instrument may be impaired. Also, YOKOGAWA Electric Corporation assumes no liability for the customer's failure to comply with these requirements.

**The following symbols are used on this instrument.**

|   |  |  |   |
|---|--|--|---|
|  | To avoid injury, death of personnel or damage to the instrument, the operator must refer to an explanation in the User's Manual or Service Manual. |   | ON(power).  |
|   |  |  | OFF(power).   |
|   |  |  | In-position of a bistable push control  |
|  | Danger, risk of electric shock   |  | Out-position of a bistable push control   |
|  | Alternating current.   |  | Function grounding terminal. This terminal should not be used as a "Protective grounding terminal". |

**Make sure to comply with the following safety precautions. Not complying might result in injury, death of personnel or damage to the instrument.**

## WARNING

### Power Supply

Ensure the source voltage matches the voltage of the power supply before turning ON the power.

### Power Cable and Plug

To prevent an electric shock or fire, be sure to use the power cord supplied by YOKOGAWA. The main power plug must be plugged in an outlet with protective grounding terminal. Do not invalidate protection by using an extension cord without protective grounding.

### Protective Grounding

Make sure to connect the protective grounding to prevent an electric shock before turning ON the power.

### Necessity of Protective Grounding

Never cut off the internal or external protective grounding wire or disconnect the wiring of protective grounding terminal. Doing so poses a potential shock hazard.

### Defect of Protective Grounding and Fuse

Do not operate the instrument when protective grounding or fuse might be defective.

### Fuse

To prevent fire, be sure to use a fuse with the specified ratings (current, voltage and type). Before replacing the fuse, turn OFF the power and unplug the power cord. Do not use any fuse other than the specified one. Also do not short-circuit the fuse holder.

### Do not Operate in an Explosive Atmosphere

Do not operate the instrument in the presence of flammable liquids or vapors. Operation of any electrical instrument in such an environment constitutes a safety hazard.

### Do not Remove any Covers

There are some areas with high voltages. Do not remove any cover if the power supply is connected. The cover should be removed by qualified personnel only.

### External Connection

To ground securely, connect the protective grounding before connecting to measurement or control unit.

# How to Use this Manual

If you are using this instrument for the first time, we suggest that you read Chapter 1 before starting operation.

| <b>Chapter</b>  | <b>Description</b>  |
|-----------------|---|
| <b>1</b>        | Main features, functions and the name of each part of the power meter   |
| <b>2</b>        | General precautions for use, installation method, how to turn the power on and off, and setting the date and time   |
| <b>3</b>        | How to connect the object to be measured, input element selection, and display using function keys  |
| <b>4</b>        | Setting measuring conditions and ranges   |
| <b>5</b>        | Operation method for measuring voltage, current, active power and peak values, and for display of computed apparent power, reactive power, power factor and phase angle |
| <b>6</b>        | Operation method for measurement of frequency   |
| <b>7</b>        | Setting and operation of efficiency, MATH, scaling and averaging functions  |
| <b>8</b>        | Setting and operation for integration of active power and current.  |
| <b>9</b>        | Operation method for harmonic analysis functions  |
| <b>10</b>       | Operation method for measuring voltage and flicker directly using the voltage fluctuation/flicker measurement function  |
| <b>11</b>       | Setting and operation for printing measured values and set-up information using the built-in printer  |
| <b>12</b>       | Setting and operation for remote control and D/A output   |
| <b>13</b>       | Storing, recalling and initializing set-up information, key lock operation, and back-up function for set-up information   |
| <b>14</b>       | Communications using a GP-IB or RS-232-C interface  |
| <b>15</b>       | Possible causes of an alarm and corrective actions, description of error codes and corrective actions, replacement of the power supply fuse, and calibration            |
| <b>16</b>       | Specifications of the instrument  |
| <b>Appendix</b> | Description of communication commands, sample programs and print examples (by the built-in printer)   |
| <b>Index</b>    | Description of important terms  |

# Conventions Used in this Manual

## Symbols used

The following symbols are used in this User's Manual.



To avoid injury or death of personnel, or damage to the instrument, the operator must refer to the User's Manual. In the User's Manual, these symbols appear on the pages to which the operator must refer.

**WARNING**

Describes precautions that should be observed to prevent the danger of serious injury or death to the user.

**CAUTION**

Describes precautions that should be observed to prevent the danger of minor or moderate injury to the user, or the damage to the property.

## Note

Provides information that is important for proper operation of the instrument.

## Key Operation Rules

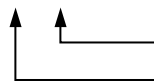

- To activate the function marked below a key, first press the SHIFT key (to light up the green indicator), then press the key. The sequence for key operation is described as follows in this manual.

**SHIFT + ENTER (KEY LOCK)** ← Function to be activated (marked below the key)



Name of the key marked on top of the key

This means that you must press the **SHIFT** key first, then press the **ENTER** key.

- On the display, "  " means that the digit indicated by "  " is blinking.



← This digit is blinking.

- The active key is indicated with a "  " as in the display example shown in the figure below.

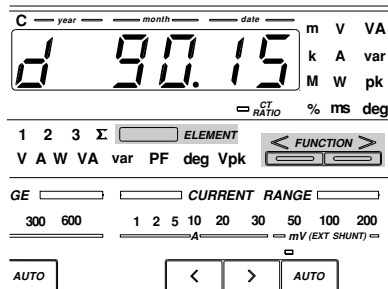

## Digital Numbers/Characters

This instrument is equipped with a 7-segment LED which imposes some restrictions on the usable characters. The numbers/characters are styled as follows.

|     |     |           |     |           |     |
|-----|-----|-----------|-----|-----------|-----|
| 0 → | A → | K →       | U → | Small u → | + → |
| 1 → | B → | L →       | V → | - →       |     |
| 2 → | C → | Small c → | M → | W →       | X → |
| 3 → | D → | N →       | X → | ÷ →       |     |
| 4 → | E → | O →       | Y → | ^ →       |     |
| 5 → | F → | P →       | Z → |           |     |
| 6 → | G → | Q →       |     |           |     |
| 7 → | H → | Small h → | R → |           |     |
| 8 → | I → | Small i → | S → |           |     |
| 9 → | J → | T →       |     |           |     |

# Contents

|  |      |
|--|------|
| <b>Foreword</b> .....  | 1    |
| <b>Checking Package Contents</b> .....                             | 2    |
| <b>Safety Precautions</b> .....                                    | 4    |
| <b>How to Use this Manual</b> .....                                | 5    |
| <b>Conventions Used in this Manual</b> .....                       | 6    |
| <b>Chapter 1 What the WT2030 Digital Power Meter Can Do</b>        |      |
| 1.1 System Configuration and Functional Block Diagram .....        | 1- 1 |
| System Configuration .....   | 1- 1 |
| Functional Block Diagram .....                                     | 1- 1 |
| 1.2 Functions .....  | 1- 2 |
| Measuring Functions .....  | 1- 2 |
| Computing Functions .....  | 1- 2 |
| Frequency Measurement Functions .....                              | 1- 2 |
| Integrator Functions .....   | 1- 2 |
| Harmonic Analysis Functions (Optional) .....                       | 1- 2 |
| Voltage Fluctuation/Flicker Measurement Functions (Optional) ..... | 1- 2 |
| External Shunt Input Functions .....                               | 1- 2 |
| Built-in Printer (Optional) .....                                  | 1- 3 |
| Communications Function .....                                      | 1- 3 |
| Other Useful Functions .....                                       | 1- 3 |
| 1.3 Over/Error Display during Measurement .....                    | 1- 4 |
| 1.4 Part Descriptions and Functions .....                          | 1- 5 |
| Front Panel .....  | 1- 5 |
| Rear Panel .....   | 1- 6 |
| <b>Chapter 2 Before Using this Instrument</b>                      |      |
| 2.1 Usage Precautions .....  | 2- 1 |
| General Handling Precautions .....                                 | 2- 1 |
| Safety Precautions .....   | 2- 1 |
| Storage Area .....   | 2- 1 |
| 2.2 Installing the Instrument .....                                | 2- 2 |
| Installation Conditions .....                                      | 2- 2 |
| Installation Position .....  | 2- 3 |
| 2.3 Power Supply Connection .....                                  | 2- 4 |
| Power Supply Requirements .....                                    | 2- 4 |
| Connecting the Power Cord .....                                    | 2- 4 |
| 2.4 Turning the Power ON or OFF .....                              | 2- 5 |
| Items to be Checked Before Turning ON the Power .....              | 2- 5 |
| Location of the Power Switch .....                                 | 2- 5 |
| Turning Power ON/OFF .....   | 2- 5 |
| Response and Display at Power ON .....                             | 2- 5 |
| Response at Power OFF .....  | 2- 5 |
| Default Settings (Factory Initialization Settings) .....           | 2- 6 |
| Opening Messages .....   | 2- 8 |



|     |                                  |      |
|-----|----------------------------------|------|
| 2.5 | Setting the Date and Time .....  | 2- 9 |
|     | Setting the Date/Time Mode ..... | 2- 9 |

**Chapter 3 Wiring**

|     |   |      |
|-----|---|------|
| 3.1 | Wiring Precautions .....  | 3- 1 |
| 3.2 | Selecting Wiring System .....                                     | 3- 2 |
|     | Precautions .....   | 3- 2 |
|     | Selecting Wiring System .....                                     | 3- 2 |
|     | Selecting Element .....   | 3- 3 |
| 3.3 | Wiring the Measurement Circuit .....                              | 3- 4 |
|     | Wiring Method when Voltage and Current are Applied Directly ..... | 3- 4 |
|     | Wiring Method when PT and CT are Used .....                       | 3- 8 |
|     | Wiring Method when External Shunt is Used .....                   | 3-10 |
| 3.4 | Improving Measurement Accuracy .....                              | 3-13 |
| 3.5 | Wiring System and Equations of Efficiency .....                   | 3-15 |

**Chapter 4 Setting Measuring Conditions and Ranges**

|     |  |      |
|-----|--|------|
| 4.1 | Setting Measuring Conditions .....   | 4- 1 |
|     | Measuring with Line Filter ON .....  | 4- 1 |
|     | Setting the Display Update Cycle (Sample Rate) .....   | 4- 2 |
|     | Display and Data Output .....  | 4- 2 |
|     | Voltage and Current Measurement Modes .....  | 4- 2 |
|     | Typical Waveform Types and Differences in Measured Values Between<br>Measurement Modes ..... | 4- 3 |
| 4.2 | Setting Measuring Ranges .....   | 4- 4 |
|     | Setting Voltage/Current Measuring Ranges for Each Element .....                              | 4- 4 |
|     | Manual and Auto Range Setting .....  | 4- 5 |
|     | Display Resolution and Power Range .....   | 4- 6 |
|     | Measuring Range for External Shunt .....   | 4- 7 |
| 4.3 | Selecting What to Display on Digital Displays .....  | 4- 9 |

**Chapter 5 Measuring Voltage, Current, Power, Peak Values, Power Factor and Phase Angle**

|     |  |      |
|-----|--|------|
| 5.1 | Measuring Voltage, Current and Active Power .....                | 5- 1 |
|     | Selecting What to Display and Element to be Measured .....       | 5- 1 |
|     | Setting Measuring Ranges .....                                   | 5- 1 |
|     | Setting Voltage/Current Measurement Mode (RMS, MEAN or DC) ..... | 5- 1 |
|     | Power Range .....  | 5- 1 |
| 5.2 | Measuring Peak Voltage and Current .....                         | 5- 2 |
|     | Setting Element to be Measured .....                             | 5- 2 |
|     | Setting Measuring Ranges .....                                   | 5- 2 |
|     | Setting Voltage/Current Measurement Mode (RMS, MEAN or DC) ..... | 5- 2 |
|     | Setting Peak Hold Mode .....                                     | 5- 2 |
| 5.3 | Displaying Computed Apparent Power .....                         | 5- 3 |
|     | Function Setting .....   | 5- 3 |
|     | Setting Element to be Measured .....                             | 5- 3 |
| 5.4 | Displaying Computed Reactive Power .....                         | 5- 4 |
|     | Function Setting .....   | 5- 4 |
|     | Setting Element to be Measured .....                             | 5- 4 |

|   |  |       |                 |
|---|--|-------|-----------------|
| 5.5   | Displaying Computed Power Factor .....   | 5- 5  | <b>1</b>        |
|   | Function Setting .....   | 5- 5  |                 |
|   | Setting Element to be Measured .....   | 5- 5  |                 |
| 5.6   | Displaying Computed Phase Angle .....  | 5- 6  | <b>2</b>        |
|   | Function Setting .....   | 5- 7  |                 |
|   | Setting Element to be Measured .....   | 5- 7  |                 |
|   | Setting Phase Angle Display Method .....   | 5- 7  | <b>3</b>        |
| <b>Chapter 6 Measuring Frequency</b>                  |  |       |                 |
| 6.1   | Measuring Frequency .....  | 6- 1  | <b>4</b>        |
|   | Display Range .....  | 6- 1  |                 |
|   | Function Setting .....   | 6- 1  | <b>5</b>        |
|   | Setting the Sample Rate .....  | 6- 1  |                 |
|   | Measuring Frequency with Filter ON .....   | 6- 1  | <b>6</b>        |
| <b>Chapter 7 Using the Computing Functions</b>        |  |       |                 |
| 7.1   | Measuring Efficiency .....   | 7- 1  | <b>7</b>        |
|   | Function Setting .....   | 7- 1  |                 |
|   | Setting Wiring System .....  | 7- 1  |                 |
| 7.2   | Measuring the Crest Factor .....   | 7- 3  | <b>8</b>        |
|   | Function Setting .....   | 7- 3  |                 |
|   | Setting the Computing Equation .....   | 7- 3  |                 |
| 7.3   | Four Arithmetical Operations Using Display D .....   | 7- 4  | <b>9</b>        |
|   | Function Setting .....   | 7- 4  |                 |
|   | Setting the Computing Equation .....   | 7- 4  |                 |
| 7.4   | Using the Scaling Function .....   | 7- 7  | <b>10</b>       |
|   | Overview of the Scaling Function .....   | 7- 7  |                 |
|   | Setting Scaling Values .....   | 7- 7  |                 |
|   | Precautions When Setting Measuring Ranges with Scaling Function ON .....   | 7- 8  | <b>11</b>       |
| 7.5   | Using Averaging Functions .....  | 7- 9  |                 |
| 7.6   | Using the NULL Function .....  | 7- 11 | <b>12</b>       |
|   | Overview of the NULL Function .....  | 7- 11 |                 |
|   | Display Content .....  | 7- 11 |                 |
|   | Measuring with NULL Function ON .....  | 7- 11 | <b>13</b>       |
| <b>Chapter 8 Integrating Active Power and Current</b> |  |       |                 |
| 8.1   | Overview of Integrator Functions .....   | 8- 1  | <b>14</b>       |
|   | Integration Modes .....  | 8- 1  |                 |
|   | There are two ways to start, stop and reset integration .....  | 8- 4  |                 |
|   | Display Update Rate (Sample Rate) .....  | 8- 4  | <b>15</b>       |
|   | Sampling Frequency and Measuring Frequency Range .....   | 8- 4  |                 |
|   | Flow of Operations .....   | 8- 5  |                 |
|   | Common Operations for All Integration Modes<br>(Setting the Date, Time and Integration Timer) .....  | 8- 6  | <b>16</b>       |
|   | Display Resolution during Integration .....  | 8- 7  |                 |
|   | Current Integration .....  | 8- 7  | <b>Appendix</b> |
| 8.2   | Setting Integration Modes .....  | 8- 8  |                 |
|   | Setting Integration Mode and Integration Timer .....   | 8- 8  |                 |
|   | Integration Using Real Time Counting Standard Integration Mode (r-nor) or<br>Real Time Counting Continuous Integration Mode (r-Cont) ..... | 8- 9  | <b>Index</b>    |

|     |   |      |
|-----|---|------|
| 8.3 | Displaying Integrated Value .....   | 8-10 |
|     | Function Setting .....  | 8-10 |
|     | Starting, Stopping and Resetting Integration .....                                  | 8-10 |
| 8.4 | Precautions Regarding Use of Integrator Function .....                              | 8-12 |
|     | Integration When Display Hold is ON .....   | 8-12 |
|     | Backup During Power Failures .....  | 8-12 |
|     | Panel Key Operation During Integration Mode .....                                   | 8-13 |
|     | Integrated Value when Instantaneous Measured Value Exceeds Measurement Limits ..... | 8-14 |

**Chapter 9 Using the Harmonic Analysis Function (Optional)**

|     |   |      |
|-----|---|------|
| 9.1 | Operating the Harmonic Analysis Function (Optional) .....   | 9- 1 |
|     | Setting the Harmonic Analysis Mode .....  | 9- 1 |
|     | Setting the PLL Source .....  | 9- 2 |
|     | Setting the Display Type .....  | 9- 3 |
|     | Setting the Harmonic Display Order .....  | 9- 3 |
|     | Setting the Upper limit of the Harmonic Order .....   | 9- 4 |
|     | Setting the Anti-aliasing Filter .....  | 9- 4 |
|     | Measuring with Frequency Filter ON .....  | 9- 5 |
|     | Setting the Harmonic Analysis Window Width .....  | 9- 5 |
| 9.2 | Selecting What to Display on Digital Displays (Optional) .....  | 9- 6 |
|     | Display A .....   | 9- 7 |
|     | Display B .....   | 9- 7 |
|     | Display C .....   | 9- 7 |
|     | Display D .....   | 9- 8 |
|     | Sample Rate .....   | 9- 8 |
| 9.3 | Displaying Fundamental and Each Harmonic of Voltage, Current, Active Power,<br>Apparent Power, Reactive Power and Power Factor as Measured Value or<br>Relative Harmonic Content (Optional) ..... | 9- 9 |
|     | Function Setting .....  | 9- 9 |
|     | Setting Element to be Displayed .....   | 9- 9 |
|     | Setting the Harmonic Order .....  | 9- 9 |
|     | Setting the Display Type .....  | 9- 9 |
| 9.4 | Displaying the Fundamental + Higher Harmonics of Voltage, Current and Active Power<br>(Optional) .....  | 9-10 |
|     | Function Setting .....  | 9-10 |
|     | Setting the Element to be Displayed .....   | 9-10 |
|     | Computing Equation .....  | 9-10 |
| 9.5 | Displaying the Harmonic Distortion (THD) (Optional) .....   | 9-11 |
|     | Function Setting .....  | 9-11 |
|     | Setting the Element to be Displayed .....   | 9-11 |
|     | Computing Equation .....  | 9-11 |
| 9.6 | Displaying the Phase Angle between the Fundamentals (Optional) .....  | 9-12 |
|     | Function Setting .....  | 9-12 |
|     | Setting the Element to be Displayed .....   | 9-12 |
|     | Setting the Harmonic Order (to the Fundamental) .....   | 9-12 |
|     | Phase Angle Display Method .....  | 9-12 |
| 9.7 | Displaying the Phase Angle of Each Higher Harmonic in Relation to the Fundamental of<br>Voltage or Current (Optional) .....   | 9-13 |
|     | Function Setting .....  | 9-13 |

|     |   |      |          |
|-----|---|------|----------|
|     | Setting the Element to be Displayed .....             | 9-13 | <b>1</b> |
|     | Setting the Harmonic Order .....                      | 9-13 | <b>2</b> |
|     | Display Method .....                                  | 9-13 | <b>3</b> |
| 9.8 | Displaying the Fundamental Frequency (Optional) ..... | 9-14 | <b>4</b> |
|     | Function Setting .....                                | 9-14 | <b>5</b> |
|     | Setting the Element to be Displayed .....             | 9-14 | <b>6</b> |

**Chapter 10 Using the Voltage Fluctuation/Flicker Measurement Functions (Optional)**

|      |  |        |           |
|------|--|--------|-----------|
| 10.1 | Using the Voltage Fluctuation/Flicker Measurement Functions (Optional) .....   | 10- 1  | <b>7</b>  |
|      | Wiring Required for Measurement of Voltage Fluctuation/Flicker .....   | 10- 1  | <b>8</b>  |
|      | Flow of Operation .....  | 10- 2  | <b>9</b>  |
|      | To Improve Measurement Accuracy .....  | 10- 2  | <b>10</b> |
| 10.2 | Operating the Voltage Fluctuation/Flicker Measurement Functions (Optional) .....   | 10- 3  | <b>11</b> |
|      | Setting Voltage Fluctuation/Flicker Measurement Mode .....   | 10- 3  | <b>12</b> |
|      | Display Update Cycle .....   | 10- 3  | <b>13</b> |
| 10.3 | Setting Measuring Conditions (Optional) .....  | 10- 4  | <b>14</b> |
|      | Setting the Nominal Voltage .....  | 10- 4  | <b>15</b> |
|      | Setting the Limit for Relative Steady-state Voltage Change .....   | 10- 5  | <b>16</b> |
|      | Setting the Limit for Maximum Relative Voltage Change .....  | 10- 6  | <b>17</b> |
|      | Setting the Limit for Period during Which Relative Voltage Change Exceeds<br>the Threshold Level during a Voltage Change and Setting the Threshold Level ..... | 10- 7  | <b>18</b> |
|      | Setting the Limit for Short-term Flicker Value .....   | 10- 8  | <b>19</b> |
|      | Setting the Limit for Long-term Flicker Value and the Constant used in the Equation .....  | 10- 9  | <b>20</b> |
|      | Setting the Observation Period for Short-term Flicker Value .....  | 10- 10 | <b>21</b> |
|      | Setting the Number of Times Measurement of Short-term Flicker Value is to be Performed .....   | 10- 11 | <b>22</b> |
|      | Setting the Steady-state Range .....   | 10- 12 | <b>23</b> |
|      | Selecting the Input Element for which Voltage Fluctuation/Flicker Measurement is Performed ...   | 10- 13 | <b>24</b> |
| 10.4 | Displaying the Voltage Fluctuation and Flicker Values (Optional) .....   | 10- 14 | <b>25</b> |
|      | Initializing Voltage Fluctuation/Flicker Measurement and Measuring Rated Voltage .....   | 10- 14 | <b>26</b> |
|      | Setting the Function for Voltage Fluctuation Measurement .....   | 10- 14 | <b>27</b> |
|      | Starting Voltage Fluctuation/Flicker Measurement .....   | 10- 14 | <b>28</b> |
|      | Data Displayed during Measurement .....  | 10- 15 | <b>29</b> |
|      | Setting the Observation Period .....   | 10- 15 | <b>30</b> |
|      | Selecting the Element to be Displayed .....  | 10- 15 | <b>31</b> |
|      | Stopping Voltage Fluctuation/Flicker Measurement .....   | 10- 15 | <b>32</b> |
| 10.5 | Displaying the Judgment Result (Optional) .....  | 10- 16 | <b>33</b> |
|      | Displaying the Observation Period .....  | 10- 16 | <b>34</b> |
|      | Changing the Element to be Displayed .....   | 10- 16 | <b>35</b> |
| 10.6 | Points to Note during Use of the Voltage Fluctuation/Flicker<br>Measurement Function (Optional) .....  | 10- 17 | <b>36</b> |
|      | Limits Specified in IEC1000-3-3 .....  | 10- 17 | <b>37</b> |
|      | Relative Steady-state Voltage Change (dc) .....  | 10- 17 | <b>38</b> |
|      | Display of dc, dmax and d (t) 200ms .....  | 10- 17 | <b>39</b> |
|      | Operating the Front Panel Keys during Voltage Fluctuation/Flicker Measurement Mode .....   | 10- 18 | <b>40</b> |

**Chapter 11 Printing Using the Built-in Printer (Optional)**

|      |   |       |                 |
|------|---|-------|-----------------|
| 11.1 | Loading a Roll Chart (Optional) .....             | 11- 1 | <b>Appendix</b> |
| 11.2 | Setting Printer Output Functions (Optional) ..... | 11- 2 | <b>Index</b>    |

|      |  |       |
|------|--|-------|
| 11.3 | Printing a Set-up Information List .....                               | 11- 6 |
|      | Set-up Information which can be Printed .....                          | 11- 6 |
| 11.4 | Printing Measured Values in Manual or Auto Print Mode (Optional) ..... | 11- 7 |
|      | Keys used for Printing .....   | 11- 7 |
|      | Printing Measured Values in Manual Print Mode .....                    | 11- 7 |
|      | Printing Measured Values in Auto Print Mode .....                      | 11- 8 |
|      | Stopping Print Out .....   | 11-10 |

## Chapter 12 Using External Input/Output Functions

|      |   |       |
|------|---|-------|
| 12.1 | External Input/Output Signals (Remote Control, D/A Output) .....  | 12- 1 |
|      | Signal Input/Output Function .....                                | 12- 1 |
|      | Pin Assignment .....  | 12- 1 |
| 12.2 | Remote Control .....  | 12- 2 |
|      | Controlling Integration .....                                     | 12- 2 |
|      | Holding Display Data Update and Updating Display Data .....       | 12- 2 |
|      | Printing Measured Values to the Built-in Printer (Optional) ..... | 12- 3 |
|      | The FLICKER BUSY signal .....                                     | 12- 3 |
|      | Remote Control Circuit .....                                      | 12- 3 |
| 12.3 | D/A Output (Optional) .....                                       | 12- 4 |
|      | Setting D/A Output .....  | 12- 4 |
|      | Output Items and D/A Output Voltage .....                         | 12- 9 |

## Chapter 13 Other Functions

|      |  |       |
|------|--|-------|
| 13.1 | Storing, Recalling and Initializing Set-up Information ..... | 13- 1 |
|      | Storing .....  | 13- 1 |
|      | Recall .....   | 13- 2 |
|      | Initialization .....   | 13- 2 |
| 13.2 | Key Lock Function .....                                      | 13- 3 |
| 13.3 | Backup Function for Set-up Information .....                 | 13- 4 |

## Chapter 14 Using the Communications Functions

|      |  |        |
|------|--|--------|
| 14.1 | Selecting the Output Items .....   | 14- 1  |
|      | Description of Output Items .....  | 14- 2  |
| 14.2 | Using the GP-IB Interface .....  | 14- 4  |
|      | Overview of the GP-IB Interface .....  | 14- 4  |
|      | GP-IB Interface Specifications .....   | 14- 4  |
|      | Response to Interface Messages .....   | 14- 5  |
|      | Switching between Remote and Local Mode .....                                  | 14- 5  |
|      | Setting the Address/Addressable Mode .....                                     | 14- 6  |
| 14.3 | Using the RS-232-C Interface .....   | 14- 7  |
|      | Overview of the RS-232-C Interface .....                                       | 14- 7  |
|      | RS-232-C Interface Specifications .....  | 14- 7  |
|      | Connecting the RS-232-C Interface Cable .....                                  | 14- 8  |
|      | Connector and Signal Names .....   | 14- 8  |
|      | Signal Direction .....   | 14- 8  |
|      | Table of RS-232-C Standard Signals and their JIS and CCITT Abbreviations ..... | 14- 9  |
|      | Setting Communications Mode, Handshake Mode, Data Format and Baud Rate .....   | 14- 10 |

**Chapter 15 Troubleshooting**

15.1 Calibration and Corrective Actions in Cases where Hardware Fails ..... 15- 1  
     Calibration ..... 15- 1  
     Apparent Hardware Failure - Check these Things First! ..... 15- 1  
 15.2 Error Codes and Corrective Actions ..... 15- 2  
     Error Codes for Operation and Measurement ..... 15- 2  
     Error Codes Regarding Self Diagnosis ..... 15- 3  
 15.3 Replacing the Power Supply Fuse ..... 15- 4  
     Fuse Position and Replacement Method ..... 15- 4  
     Fuse Ratings ..... 15- 4  
     Replacing the Fuse ..... 15- 4  
 15.4 Recommended Parts for Replacement ..... 15- 5

**Chapter 16 Specifications**

16.1 Specifications ..... 16- 1  
     Input ..... 16- 1  
     Display Functions ..... 16- 1  
     Accuracy ..... 16- 1  
     Frequency Measurement Function ..... 16- 1  
     Computing Functions ..... 16- 2  
     Integration Functions ..... 16- 2  
     Communications Functions ..... 16- 2  
     External Control ..... 16- 2  
     Printer (Optional) ..... 16- 2  
     D/A Output (Optional) ..... 16- 2  
     Harmonic analysis function (Optional) ..... 16- 2  
     Flicker measurement (Optional) ..... 16- 3  
     General Specifications ..... 16- 3  
 16.2 External Dimensions ..... 16- 4

**Appendix 1 Communication Commands 1**

App 1.1 List of Communications Commands ..... App 1-1  
 App 1.2 Commands ..... App 1-3  
 App 1.3 Status Byte Format ..... App 1-17  
 App 1.4 Data Output Format ..... App 1-18  
 App 1.5 For Users Using Communications Command of Digital Power Meter 2533E ..... App 1-27  
 App 1.6 For Users Using Communications Command of Digital Power Meter 2531 ..... App 1-30  
 App 1.7 Sample Programs ..... App 1-34

**Appendix 2 Communication Commands 2**

App 2.1 IEEE 488.2-1987 Specifications ..... App 2-1  
 App 2.2 Program Format ..... App 2-2  
     2.2.1 Syntax Symbols ..... App 2-2  
     2.2.2 Messages ..... App 2-2  
     2.2.3 Commands ..... App 2-4  
     2.2.4 Response ..... App 2-6  
     2.2.5 Data ..... App 2-6  
     2.2.6 Synchronization with the Controller ..... App 2-8



|         |                                    |          |
|---------|------------------------------------|----------|
| App 2.3 | Commands .....                     | App 2-9  |
| 2.3.1   | Command List .....                 | App 2-9  |
| 2.3.2   | AOUTput Group .....                | App 2-14 |
| 2.3.3   | COMMunicate Group .....            | App 2-16 |
| 2.3.4   | CONFigure Group .....              | App 2-18 |
| 2.3.5   | DISPlay Group .....                | App 2-24 |
| 2.3.6   | FLICKer Group .....                | App 2-25 |
| 2.3.7   | HARMonics Group .....              | App 2-30 |
| 2.3.8   | INTEGrate Group .....              | App 2-32 |
| 2.3.9   | MATH Group .....                   | App 2-34 |
| 2.3.10  | MEASure Group .....                | App 2-35 |
| 2.3.11  | PRINt Group .....                  | App 2-45 |
| 2.3.12  | RECall Group .....                 | App 2-50 |
| 2.3.13  | SAMPle Group .....                 | App 2-50 |
| 2.3.14  | STATus Group .....                 | App 2-51 |
| 2.3.15  | STORe Group .....                  | App 2-52 |
| 2.3.16  | SYSTem Group .....                 | App 2-53 |
| 2.3.17  | Common Command Group .....         | App 2-54 |
| App 2.4 | Status Report .....                | App 2-56 |
| 2.4.1   | Status Report .....                | App 2-56 |
| 2.4.2   | Status Byte .....                  | App 2-57 |
| 2.4.3   | Standard Event Register .....      | App 2-58 |
| 2.4.4   | Extended Event Register .....      | App 2-59 |
| 2.4.5   | Output Queue and Error Queue ..... | App 2-60 |
| App 2.5 | Sample Programs .....              | App 2-61 |
| App 2.6 | ASCII Character Code .....         | App 2-66 |
| App 2.7 | Communication Error Messages ..... | App 2-67 |

|  |         |
|--|---------|
| <b>Appendix 3 Print Examples</b> ..... | App 3-1 |
|--|---------|

**Index**

# 1.1 System Configuration and Functional Block Diagram

## System Configuration

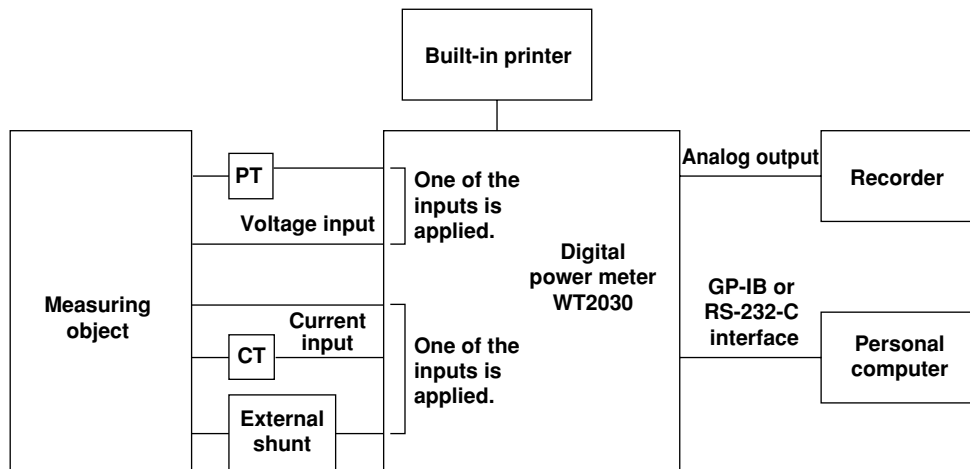

## Functional Block Diagram

### Operation Principle and Circuit Structure

The WT2030 Digital Power Meter consists of various sections; input, DSP (Digital Signal Processor), CPU and display sections. The Input section consists of the voltage input circuit and the current input circuit, and there are isolated from each other. In the voltage input circuit, the input voltage is normalized by a voltage divider and operational amplifier, then sent to the A/D converter. In the current input circuit, the input current is converted into voltage by a shunt resistor, amplified and normalized by an operational amplifier, and then sent to the A/D converter.

The output from the A/D converter in the current input and voltage input circuits is sent to the DSP via a photo-isolator, which is used to provide insulation between the current input circuit (or voltage input circuit) and the DSP. The DSP performs computation of voltage, current, active power, apparent power, reactive power, power factor and phase angle, using the output data of the A/D converter.

Computation results are then sent from the DSP to the CPU, where computation such as range conversion, sigma computation and scaling is carried out, and the results are then displayed on the displays of the instrument.

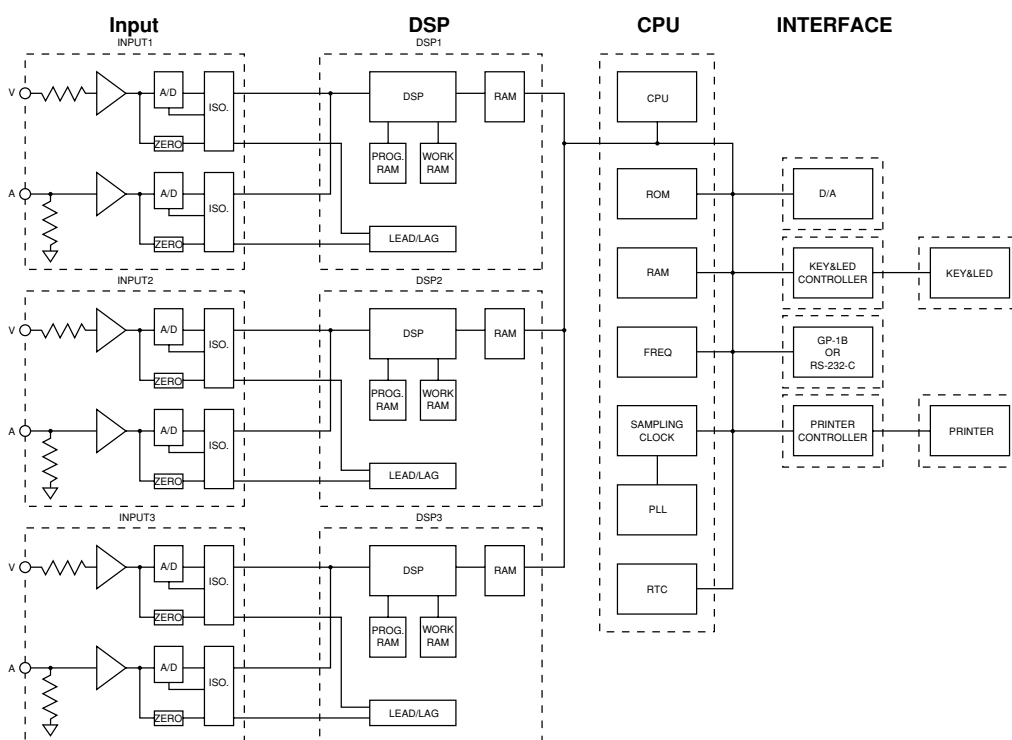



---

## 1.2 Functions

### Measuring Functions

This function enables measurement of voltage (rms value, mean-value rectification calibration, linear averaging), current (rms value, mean-value rectification calibration, linear averaging) and active power.

Voltage range : 10 V, 15 V, 30 V, 60 V, 100 V, 150 V, 300 V and 600 V

Current range : 1 A, 2 A, 5 A, 10 A, 20 A, 30 A

External shunt input range : 50 mV, 100 mV and 200 mV

### Computing Functions

This function enables computation of active power, apparent power, reactive power, power factor and phase angle, using input voltage and current.

When performing measurements with an external PT and shunt connected, the scaling function is very useful. This function enables display of the measured values in terms of the primary-side values by setting the scaling factor according to the primary/secondary ratio. When this function is used, the active power, apparent power, reactive power and integrated power are multiplied by the scaling factor, then displayed.

An averaging function is also available. This function is used to perform exponential or moving averaging on the measured values before displaying them in cases where the measured values are not stable.

### Frequency Measurement Functions

This functions enables measurement of the frequency of an input voltage or input current.

Measuring range: 2 Hz to 1 MHz

### Integrator Function

This function enables integration of active power and current. Integrated values (power or current) and elapsed time of integration can be displayed during integration. Furthermore, display of positive and negative integrated values is also possible. This enables the positive watt-hour (i.e. watt-hour consumed only in positive direction) and negative watt-hour (i.e. watt-hour returned in negative direction to the power supply) to be displayed independently. However, only the measured power is displayed during integration.

### Harmonic Analysis Functions (Optional)

This function enables measurement of up to the 50th harmonic of voltage, current and power, and relative content for each order, as well as phase angle relative to the reference wave for each order, in accordance with IEC1000-3-2. It also enables computation of total rms value (fundamental waveform + harmonics) of voltage, current and total active power, harmonic distortion rate (THD), apparent power and inactive power of the fundamental waveform (first order).

### Voltage Fluctuation/Flicker Measurement Functions (Optional)

This function enables measurement of voltage fluctuation and flicker in accordance with IEC 1000-3-3.

### External Shunt Input Functions

This function enables measurement of current exceeding 30 A, by using an external voltage-output type shunt.

### Built-in Printer (Optional)

The built-in printer enables printing of set-up items. It can also print voltage, current, active power and phase angle in the form of a bar graph during harmonic analysis. Furthermore, the printer can be set so that it automatically prints at certain intervals.

During measurement of flicker, the printer can print the relative steady-state voltage change, maximum relative voltage change and the maximum period during which relative voltage exceeds the threshold level within one voltage change, as well as printing the short-term flicker value and cumulative probability function graph.

### Communications Function

Either a GP-IB or RS-232-C interface is provided as standard according to the customer's preference. Measured/computed data can be sent to a personal computer through the interface. It is also possible to control this instrument from the personal computer.

### Other Useful Functions

#### Remote Control Signals and D/A Outputs

The following functions can be performed using remote controlled input/output signals (contact or logic-level (TTL, active low).)

#### External Input Signals

##### $\overline{\text{EXT HOLD}}$

Holds updating of the displayed values or releases the hold status.

##### $\overline{\text{EXT TRIG}}$

Updates the displayed values in hold mode.

##### $\overline{\text{EXT START}}$

Starts integration.

##### $\overline{\text{EXT STOP}}$

Stops integration.

##### $\overline{\text{EXT RESET}}$

Resets integration.

##### $\overline{\text{EXT PRINT}}$

Starts printing.

#### External Output Signals

##### $\overline{\text{INTEG BUSY}}$

Output during integration.

##### $\overline{\text{FLICKER BUSY}}$

Output during measurement of flicker.

#### D/A output (optional)

Outputs specified measured items as a DC analog signal with full scale of +/-5V. Output items up to 14 channels can be selected.

#### Set-up Information Backup Function

The instrument has a function that backs up the set-up information (including integrated values) in case power is cut off accidentally as a result of a power failure or for any other reason.

#### Set-up Information Initialization Function

The instrument also has a function that resets the set-up information to the factory settings.

# 1.3 Over/Error Display during Measurement

## Display at Measurement Error

### Over range

In normal measurement, an over range occurs if the measured voltage or current exceeds 140% of the rated value for the range used. In auto range setting range, an over range error occurs if **140% of the rated value for the maximum range** is exceeded. The following code will appear on the display in case of an over range.

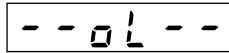

During harmonic analysis, an over range also occurs if the total rms voltage or current value (fundamental waveform + harmonics) exceeds the measuring range as follows.

|                           |      |
|---------------------------|------|
| 600 V range               | 140% |
| 30 A range                | 140% |
| 20 A range                | 210% |
| 200 mV range (EXT SENSOR) | 140% |
| Other ranges              | 250% |

### Computation overflow

If a computed value cannot be displayed with the specified decimal point position or unit of measurement, the following code will appear on the display.

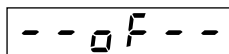

### Peak overflow

If the peak value of the input voltage or current exceeds approximately 350% of the range (or approximately 700% if the crest factor is 6), the PEAK OVER LED of the element in which the peak overflow occurs will light up.

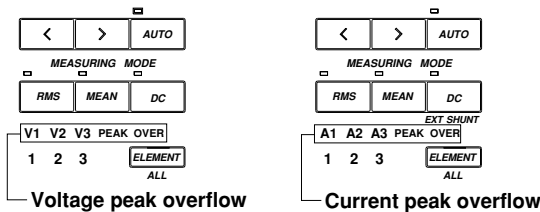

### When measured voltage or current is below 0.3% of the rated value of the range used

If the measured voltage or current is below 0.3% of the rated value, the following will appear on the display. (Applicable when the measurement mode is RMS or MEAN)

| Function             | Display           |
|----------------------|-------------------|
| V (voltage)          |                   |
| A (current)          | "0" is displayed. |
| VA (apparent power)  |                   |
| var (reactive power) |                   |
| PF (power factor)    | PFERR             |
| deg (phase angle)    | DEERR             |

### Interruption during measurement

If the measuring range or display item is changed during measurement, the following will appear on the display. It will also appear if no measured or computed value is present due to measurement conditions.

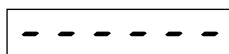

# 1.4 Part Descriptions and Functions

## Front Panel

The number to the right of the name of each key corresponds to the page number where detailed information about the key function can be found.

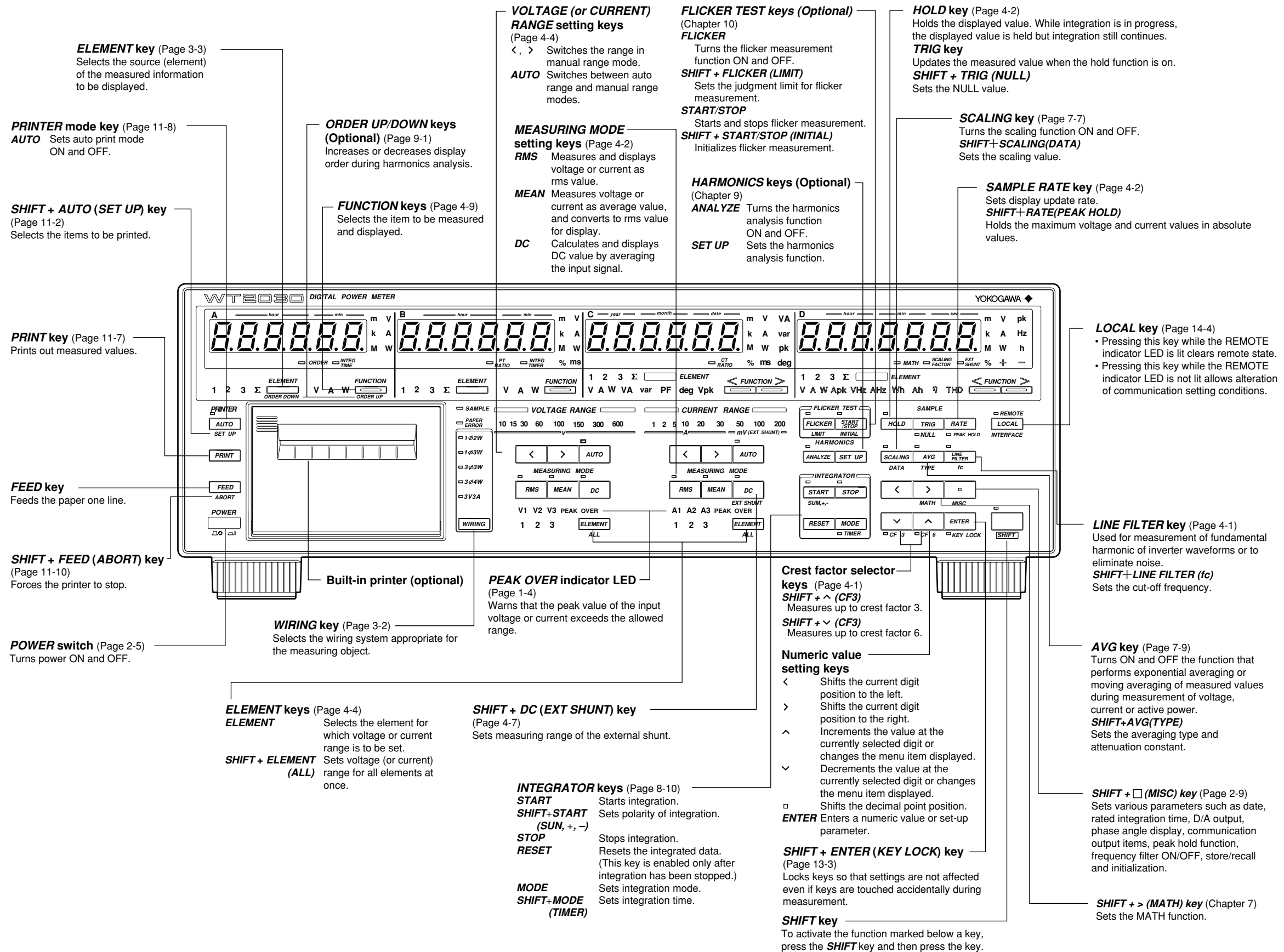

Rear Panel

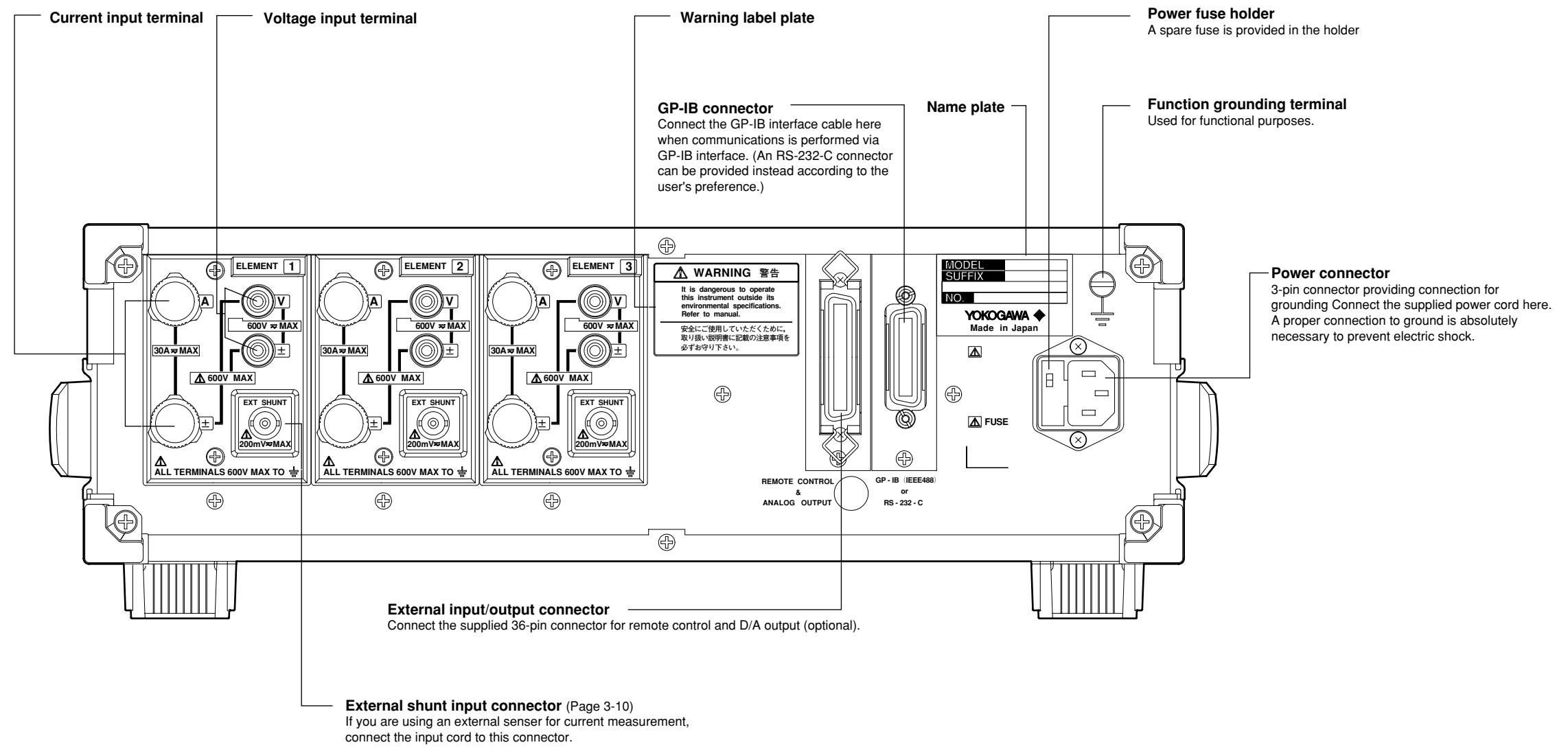

## 2.1 Usage Precautions

### General Handling Precautions

Observe the following precautions when handling the instrument.

- Never place anything on top of the instrument, especially objects containing water. Entry of water into the instrument may result in breakdowns.
- Observe the following precautions when moving the instrument.  
Disconnect the power cords and connecting cables.  
Always carry the instrument by the handles as shown below.

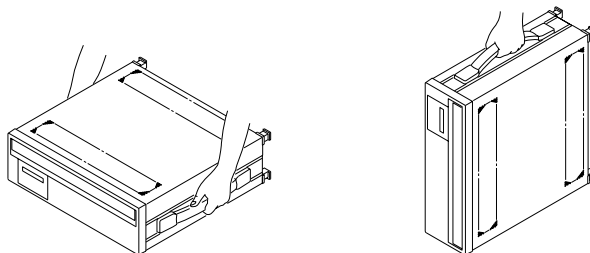

- To prevent internal temperature rise, do not block the vent holes in the instrument case.
- Keep input/output terminals away from electrically charged articles as they may damage internal circuits.
- Do not allow volatile chemicals to come into contact with the case or operation panel. Also do not leave any rubber or vinyl products in contact with them for prolonged periods. Doing so may result in breakdowns.
- The operation panel is made of thermoplastic resin, so take care not to allow any heated articles such as a soldering iron to come into contact with it.
- If the instrument will not be used for a long period, unplug the power cord from the AC outlet.
- For cleaning the case and the operation panel, unplug the power cord first, then gently wipe with a dry, soft, clean cloth. Do not use chemicals such as benzene or thinner, since these may cause discoloration or damage.

### Safety Precautions

- Do not remove the case from the instrument.  
Some areas in the instrument use high voltages, which are very dangerous.  
When the instrument needs internal inspection or adjustment, contact your dealer or nearest YOKOGAWA representative.
- If you notice smoke or unusual odors coming from the instrument, immediately turn OFF the power and unplug the power cord. Also turn OFF the power to all the objects being measured that are connected to the input terminals. If an such irregularity occurs, contact your dealer or the nearest YOKOGAWA representative.
- Do not place anything on the power cord. Also keep it away from any heat generating articles. If the power cord is damaged, contact your dealer or nearest YOKOGAWA representative.
- When unplugging the power cord from the AC outlet, never pull the cord itself. Always hold the plug and pull it.

### Storage Area

Never store the instrument in places where it may be exposed to any of the following conditions.

- Relative humidity of 80% or higher
- Direct sunlight
- Temperature of 60°C or higher.
- Proximity to any high-temperature heat sources
- Excessive vibration
- Corrosive or flammable gases
- Excessive amount of dust, dirt, salt or iron filings
- Splashes of water, oil or chemicals

---

## 2.2 Installing the Instrument

### Installation Conditions

The instrument must be installed in a place where the following conditions are met.

- **Ambient temperature and humidity**

Ambient temperature : 5 to 40°C

Ambient humidity : 20 to 80% RH (no condensation)

- **Well-ventilated place**

Vent holes are provided on the top and bottom of the instrument. To prevent rise in internal temperature, do not block these vent holes.

### **Note**

---

- To ensure high measurement accuracy, the instrument should only be used under the following conditions.

Ambient temperature : 23 ±3°C

Ambient humidity : 30 to 75% RH (no condensation)

When using the instrument in the temperature ranges of 5 to 18 or 28 to 40°C, multiply the measured values by the temperature coefficient specified in Chapter 16, "Specifications."

- If the ambient humidity of the installation site is 30% or below, use an anti-static mat to prevent generation of static electricity.
  - Internal condensation may occur if the instrument is moved to another place where both ambient temperature and humidity are higher, or if the room temperature changes rapidly. In such cases acclimatize the instrument to the new environment for at least one hour before starting operation.
- 

Never install the instrument in the following places. Otherwise, the internal circuits and the case may be affected adversely, hindering accurate measurement.

- **In direct sunlight or near heat sources**
- **Where an excessive amount of soot, steam, dust or corrosive gases is present.**
- **Near magnetic field sources**
- **Near noise sources such as high voltage equipment or power lines**
- **Where the level of mechanical vibration is high**
- **In an unstable place**

## Installation Position

### Desktop Installation

Place the instrument in a horizontal position or tilted using the stand as shown below.

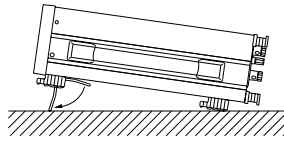

### Rack Mount

To install the instrument in a rack, use one of the following optional rack mount kits.

#### Rack mount kit (optional)

| Kit Name       | Model     | Standard |
|----------------|-----------|----------|
| Rack mount kit | 751535-E3 | EIA      |
| Rack mount kit | 751535-J3 | JIS      |

### Mounting Procedure

1. Remove the seal cover from the mounting holes on both sides of the instrument. (Four seal covers in total)
2. Attach the mount kit as shown below.
3. Remove the four legs from the bottom of the instrument.
4. Remove the handle from each side of the instrument.
5. Cover each handle mount hole with a seal.
6. Mount the instrument in the rack.
  - When mounting the instrument, support it from underneath.
  - Refer to Chapter 16, "Specifications" for rack mounting dimensions.

### Note

- The upper and lower sides of the instrument are equipped with ventilation holes. When these are blocked e.g. due to rack mounting, the specified accuracy may not be met, therefore allow at least 20 mm of space between the ventilation holes and the rack mount.

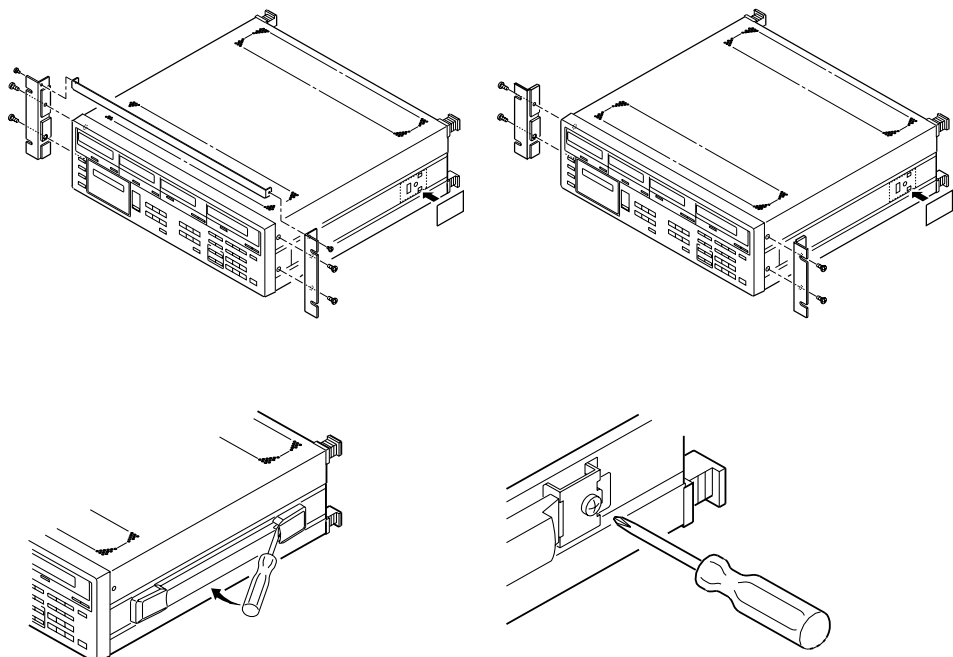



## 2.3 Power Supply Connection

### Power Supply Requirements

The useable supply voltage of this instrument varies depending on the suffix code.

|  |                 |                |                |                |
|--|-----------------|----------------|----------------|----------------|
| Suffix code                              | : -1            | -3             | -5             | -7             |
| Rated supply voltage                     | : 100 VAC       | 115 VAC        | 200 VAC        | 230 VAC        |
| Permitted supply voltage range           | : 90 to 110 VAC | 100 to 132 VAC | 180 to 220 VAC | 198 to 264 VAC |
| Rated supply voltage frequency           | : 50/60 Hz      | 50/60 Hz       | 50/60 Hz       | 50/60 Hz       |
| Permitted supply voltage frequency range | : 48 to 63 Hz   | 48 to 63 Hz    | 48 to 63 Hz    | 48 to 63 Hz    |



#### CAUTION

- Before plugging in the power cord, make sure that the voltage of the AC outlet fits with the rated supply voltage on the rear panel of the instrument.
- When checking the power supply fuse, refer to Section 15.3 "Replacing the Power Supply Fuse" (page 15-4).
- When checking the power cord, refer to the ratings specified in the suffix code in "Checking Package Contents" (page 2).

### Connecting the Power Cord



#### WARNING

- Be sure to connect the protective grounding to prevent an electric shock before turning on the power. Connect the power cord only after having verified that the power switch is turned OFF.
- Before plugging in the power cord, make sure that the voltage of the AC outlet is within the specified range.
- To prevent electric shock or fire, use only the power cord supplied by YOKOGAWA.
- Never use an extension cord without a grounding wire, otherwise the protection feature will be invalidated.

## 2.4 Turning the Power ON or OFF

### Items to be Checked Before Turning ON the Power

- Check whether the power supply voltage from the AC outlet matches the one selected by the voltage selector switch.
- Check that the instrument is installed correctly as instructed in Section 2.2 "Installing the Instrument" (page 2-2).

### Location of the Power Switch

The power switch is located in the lower left corner of the front panel.

### Turning Power ON/OFF

A pushbutton switch is used as the power switch. The power is turned ON and OFF alternatively as the switch is pressed.

#### **Note**

- The instrument uses a lithium battery so that set-up information together with the date and time entered from the operation panel will be backed up and not lost in case of power failure.
- A warm-up time of approximately 30 minutes is required before all specifications of the instrument are met. However, a warm-up time of approximately 2 hours is required before start of flicker measurement.

### Response and Display at Power ON

When the power switch is turned ON, the test program starts. The test program checks each memory. If the check results are satisfactory, opening messages will appear as shown on page 2-7, and the instrument is ready for measurement.

If an error code appears at the end of the test program, the instrument is not functioning properly. In this case, turn OFF the power immediately, and contact your dealer or the nearest YOKOGAWA representative. Inform them of the model name and serial no. specified on the name plate on the rear panel, as well as the error code that was displayed.

#### **Note**

- In the case of an error code, refer to Section 15.2 "Error Codes and Corrective Actions" (page 15-2), and carry out the specified corrective actions.

### Response at Power OFF

When the power switch is turned OFF, the set-up information which was in effect just prior to the power switch being turned OFF will be retained. Thus, when the power switch is next turned ON, the operation state of the instrument just prior to the power switch being turned OFF will be resumed.

#### **Note**

- The set-up information is backed up by a lithium battery. The battery lasts for approximately ten years if it is used at an ambient temperature of 23°C. If the battery runs out, an error code appears when the power switch is turned ON (refer to 15.2, "Error Codes and Corrective Actions"). In this case, the battery needs to be replaced immediately. The battery cannot be replaced by the user. Contact your dealer or the nearest YOKOGAWA representative.

**Default Settings (Factory Initialization Settings)**

|                        | <b>Display</b>   | <b>Factor</b>                   | <b>LED</b>  |
|------------------------|--|---------------------------------|-------------|
| Display                | A  | V1                              | 1, V        |
|                        | B  | A1                              | 1, A        |
|                        | C  | W1                              | 1, kW       |
|                        | D  | W1                              | 1, kW       |
| Measuring range        | VOLTAGE  | 600V                            | 600V        |
|                        | AMP  | 30A                             | 30A         |
|                        | Shunt scaling value  | 50.000A/FS                      |             |
| Measurement mode       | RMS/MEAN/DC  | RMS                             | RMS         |
| Measuring conditions   | Wiring system  | 1 $\phi$ 2W                     | 1 $\phi$ 2W |
|                        | Hold   | OFF                             |             |
|                        | Sample rate  | 500ms                           |             |
|                        | Scaling  | OFF                             |             |
|                        | Averaging  | OFF                             |             |
|                        | Line filter  | OFF                             |             |
|                        | Cut-off frequency  | 0.5kHz                          |             |
|                        | Crest factor   | 3                               |             |
|                        | Peak hold  | OFF                             |             |
|                        | Peak hold function   | Peak                            |             |
|                        | Frequency filter   | OFF                             |             |
|                        | NULL function  | OFF                             |             |
|                        | Integration  | Invalid                         |             |
|                        | Harmonic analysis (optional)   | OFF                             |             |
|                        | Phase angle display  | 180°                            |             |
| MATH                   | Efficiency (EFF)   |                                 |             |
| Key lock               | OFF  |                                 |             |
| Scaling constant       | Kv   | 1.0000                          |             |
|                        | Ki   | 1.0000                          |             |
|                        | Kw   | 1.0000                          |             |
| Averaging              | Averaging method   | Exponential averaging (EXP)     |             |
|                        | Attenuation constant   | 8                               |             |
| Integration            | Integration mode   | Standard integration mode (INT) |             |
|                        | Integration timer  | 0 h 0 min                       |             |
|                        | Integration polarity   | SUM                             |             |
| Communications         |  |                                 |             |
| Command group          | Used to select 2531 command group whether the scaling constant is to be selected for all the elements at once or for one element at a time. Also used to select WT2000 command group or 2533E command group. | CM3 (WT2000 command group)      |             |
| GP-IB                  | Address  | 1                               |             |
|                        | Output interval during talk-only mode  | 0 s                             |             |
|                        | Communication mode   | A                               |             |
|                        | Status byte  | 15                              |             |
|                        | Delimiter  | CR+LF                           |             |
| RS-232-C               | Communications mode  | Normal                          |             |
|                        | Output interval during talk-only mode  | 0 s                             |             |
|                        | Handshake mode   | 0                               |             |
|                        | Format   | 0                               |             |
|                        | Baud rate  | 9600                            |             |
|                        | Delimiter  | CR+LF                           |             |
|                        | Status byte  | 15                              |             |
| GP-IB, RS-232-C Common | Communications output  | ASCII                           |             |
|                        | Communications output function   | ASCII                           |             |

|                                |   |                     |
|--------------------------------|---|---------------------|
| Harmonic analysis (optional)   | Display format  | n-th harmonic       |
|                                | PLL source  | V1                  |
|                                | Number of orders  | 50                  |
|                                | THD equation  | IEC                 |
|                                | Harmonic order  | 1                   |
|                                | Anti-aliasing filter  | OFF                 |
|                                | Window width  | 16                  |
| Flicker measurement (optional) | Rated voltage setting   | Auto                |
|                                | Existing rated voltage  | 230 V               |
|                                | Limit for relative steady-state voltage change                                      | ON, 3.00%           |
|                                | Limit for maximum relative voltage change   | ON, 4.00%           |
|                                | Duration during which voltage exceeds the threshold level within one voltage change | ON, 200 ms, 3.00%   |
|                                | Limit for short-term flicker value  | ON, 1.00            |
|                                | Limit for long-term flicker value   | ON, 0.65            |
|                                | Constant used in the equation for long-term flicker value                           | 12                  |
|                                | Observation period for short-term flicker value                                     | 10 min              |
|                                | Number of times measurement is performed for short-term flicker value               | 12                  |
|                                | Steady-state range  | 0.10%               |
|                                | Input elements  | Element 1           |
|                                | Printer (optional)  | Auto print mode     |
| Print interval                 |   | 1 min               |
| Print synchronization          |   | Synchronize to time |
| Print output function          |   | $dF_{L\%} - I$      |
| D/A output (optional)          | D/A output  | $dF_{L\%} - I$      |
|                                | Rated integration time for D/A output   | 1 h 0 min           |

### Opening Messages

When the power switch is turned ON, the following messages will appear. The messages vary depending on the options used. If the power switch is turned ON with the **SHIFT** key held down, no message for any optional functions will be displayed. Once this is done, no message for any optional functions will be displayed whenever the power switch is turned ON. To display messages for optional functions, turn ON the power switch again while holding down the **SHIFT** key.

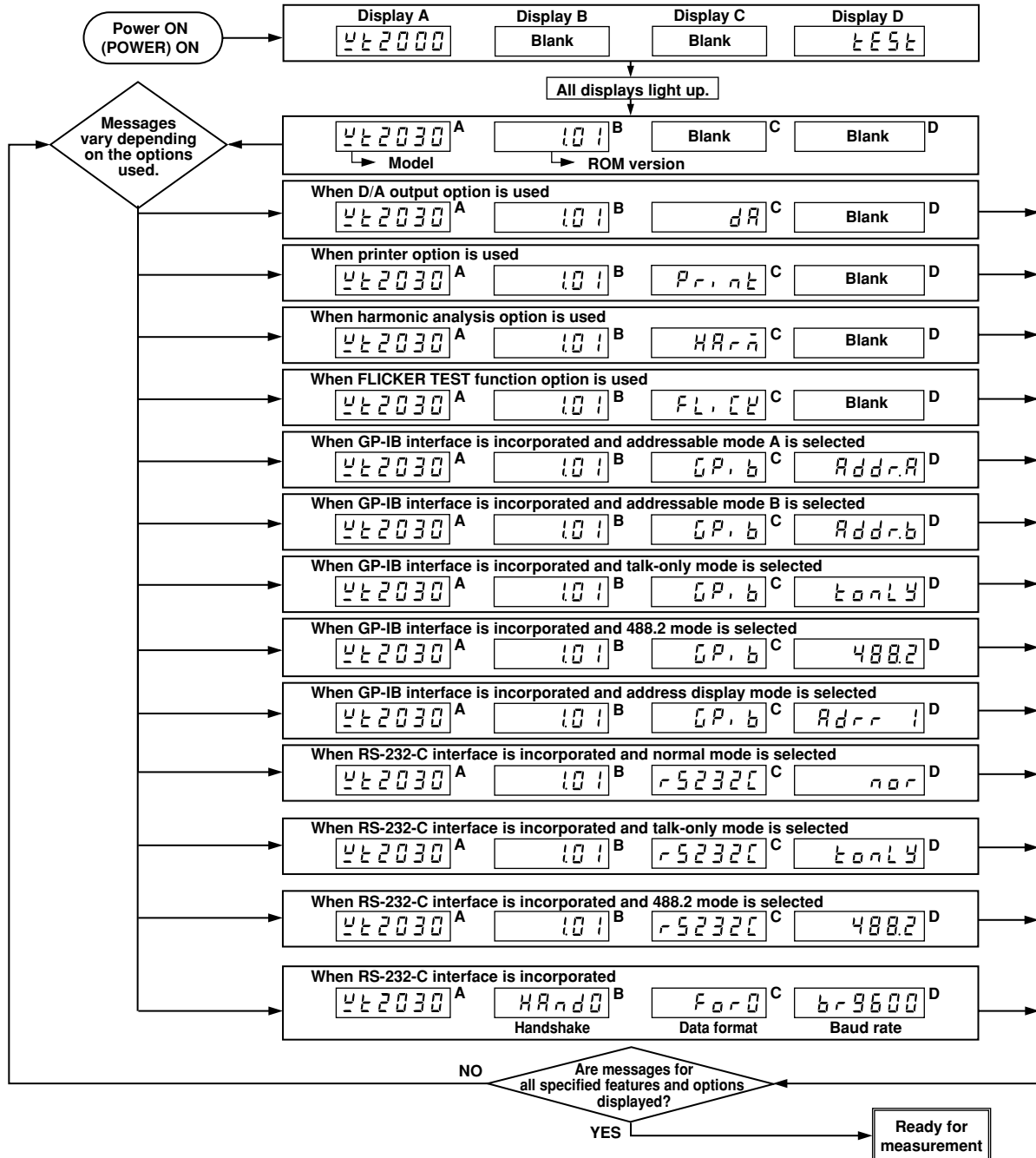

## 2.5 Setting the Date and Time

### Setting the Date/Time Mode

#### Mode Setting

1. Press the **MISC** key (**SHIFT** +  $\square$ )  
Keep pressing the up  $\wedge$  or down  $\vee$  key until "DATE" appears on display D.
2. Press the **ENTER** key.  
"DATE" moves to display A, and the date and time currently set appear on displays C and D respectively. The leftmost digit of display C (date) starts blinking.

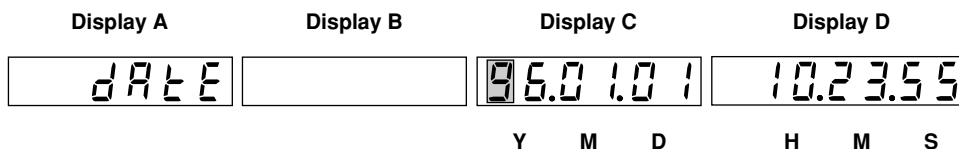

#### Setting the Date and Time

3. Set the desired value for the blinking digit using the  $\wedge$  or  $\vee$  key. Press the  $<$  or  $>$  key to move to another digit and set a value. Repeat this step until the entire date has been set.
4. When the entire date has been set, press the **ENTER** key. This causes the leftmost digit of display D (time) to start blinking. Repeat step 3 to set the desired time.
5. When the time has been set, press the **ENTER** key. The timer begins to operate.

#### Shifting the Blinking Position

The blinking position can be shifted to the left or right by pressing the  $<$  or  $>$  key. Pressing the  $<$  key causes the digit to the left of the currently blinking digit to blink, and pressing the  $>$  key causes the digit to the right of the currently blinking digit to blink. The blinking position wraps around in both directions.

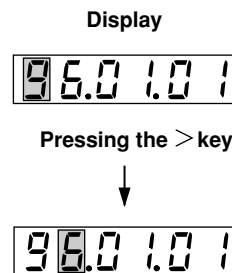

#### Setting a Value

To select a value for the blinking digit, press the  $\wedge$  or  $\vee$  key. Pressing the  $\wedge$  key changes the value according to the sequence 1, 2, 3 ... 9, 0 and back to 1. Pressing the  $\vee$  key changes the value in the opposite direction.

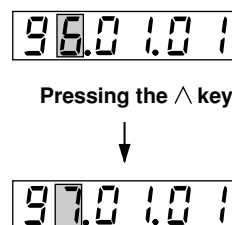

#### Note

- If the time is not set properly, "Err 18" will appear.
- Years whose final two digits are less than "96" will be treated as 21st century years.

|    |   |      |   |   |   |
|----|---|------|---|---|---|
| 00 | → | 2000 | : | : | : |
|    |   |      |   |   |   |
| 95 | → | 2095 | : | : | : |
| 96 | → | 1996 | : | : | : |
|    |   |      |   |   |   |
| 99 | → | 1999 |   |   |   |

## 3.1 Wiring Precautions



### WARNING

- To prevent hazards, a protective grounding connection must be made as follows. The power cord supplied with the instrument has a 3-pin plug. One of the three pins is used for grounding. The power cord must be connected to a 3-pin AC outlet (including a grounding terminal).
- Always turn OFF the power to the object being measured, before connecting it to the instrument. Never connect or disconnect the measurement lead wires from the object while power is being supplied to it, otherwise a serious accident may result.
- Be sure that you do not connect a current circuit to the voltage input terminal or vice versa. Incorrect connection may cause damage not only to the circuit or equipment under test and to this instrument, but may also endanger the operator.
- When the power switch is ON, never apply a voltage or current exceeding the level specified in the table below to the voltage input terminal or current input terminal. If the power switch is OFF, turn OFF the power to the object.

| Permissible Maximum Input             | Voltage Input  | Current Input  |
|---------------------------------------|--|--|
| Maximum Instantaneous Input (for 1 s) | The peak value is 2.5 kV or RMS value is 3.0 kV, whichever is the lower. | The peak value is 90 A or RMS value is 50 A, whichever is the lower. Peak current of 20 times the rated measuring range or lower in the case where an external input is used |
| Maximum Continuous Input              | The peak value is 1.4 kV or RMS value is 2.5 kV, whichever is the lower. | The peak value is 60 A or RMS value is 35 A, whichever is the lower. Peak current of 10 times the rated measuring range or lower in the case where an external input is used |

- If you want to use an external current transformer (CT), use one which has a sufficient withstand voltage against the voltage to be measured. Also be sure not to allow the secondary side of the CT to go open-circuit while power is supplied, otherwise an extremely dangerous high voltage will be generated on the secondary side of the CT.
- If the instrument is used in a rack, provide a power switch so that power to the instrument can be shut off from the front of the rack in an emergency.
- Make sure that the bare end of the measurement lead wire connected to each input terminal does not protrude from the terminal. Also make sure that the measurement lead wires are connected to the terminals securely. Do not use any plug-in type terminal with protruding bare lead wire (e.g. banana-shaped terminal connector) to connect the object to the voltage terminal. This may lead to a very dangerous situation if the input terminal is disconnected.
- The voltage ratings across the measuring (voltage and current) input and the ground for this instrument varies under operating conditions.
  - When protective covers are used on GP-IB or RS-232-C and external input/output connectors  
Voltage across each measuring input terminal and ground 600 Vrms max.
  - When protective covers are removed from GP-IB or RS-232-C and from external input/output connectors; or when connectors are used  
Voltage across A,  $\pm(V$  and A side) input terminals and ground 400 Vrms max.  
Voltage across V terminal and ground 600 Vrms max.



### CAUTION

- The lead wires must have a sufficient margin in both breakdown voltage and current against those to be measured. They must also have insulation resistance appropriate to their ratings.  
Example: If measurement is carried out on a current of 20 A, use copper wires with a conductor cross-sectional area of at least 4 mm<sup>2</sup>.

### Note

- After completion of the wiring, the **WIRING** key needs to be used to select the wiring system before starting measurements. Refer to Section 3.2 "Selecting Wiring System" (page 3-2) for a description of the procedures.
- When measuring high currents, or currents or voltages that contain high-frequency components, wiring should be made with special attention paid to possible mutual interference and noise problems.
- Keep the lead wires as short as possible.
- For current circuits indicated by thick lines in the wiring diagrams shown in Section 3.3 (page 3-4 and subsequent pages), use thick lead wires appropriate for the current to be measured.
- The lead wire to the voltage input terminal should be connected as close to the load of the object under measurement as possible.
- To minimize stray capacitance to ground, route both lead wires and grounding wires so that they are as away from the instrument's case as possible.

## 3.2 Selecting Wiring System

### Precautions

Make sure that the wiring system that matches the actual wiring is selected, otherwise a measurement error will occur. (Computation method varies according to the wiring system.)

### Selecting Wiring System

The wiring system is selected in the sequence shown below each time the **WIRING** key is pressed. The LED for the selected wiring system lights up. Select the wiring system type that matches the one you have assembled.

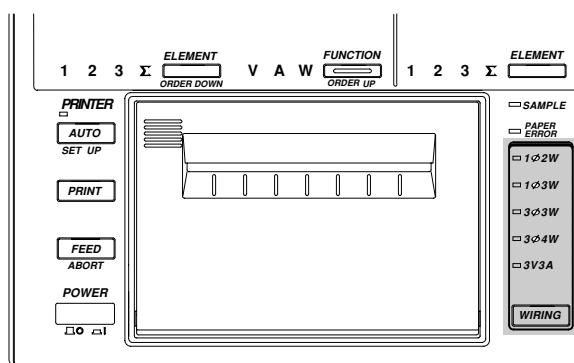

#### Three-phase, three-wire model (253102)

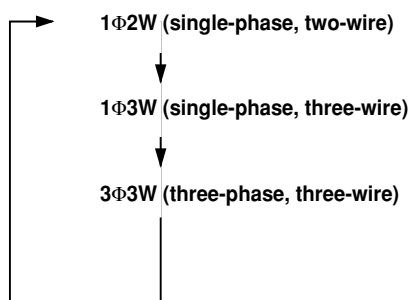

#### Three-phase, four-wire model (253103)

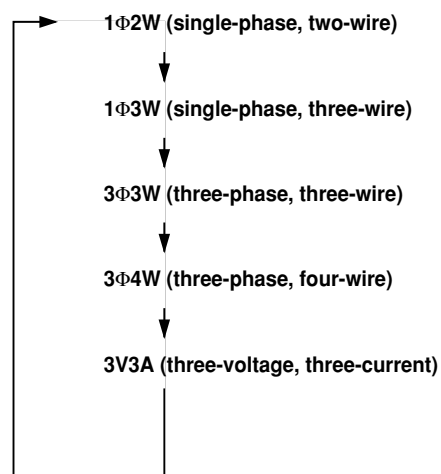

### Note

- When measuring apparent power, reactive power, power factor, phase angle or efficiency, selecting a wiring system different from the actual wiring system connected to the input terminals hinders accurate measurement. Make sure that the correct wiring system is selected.
- Selectable wiring systems differ from model to model. Refer to "Wiring System Selection and Selectable Measuring Objects (Elements)" on the next page.



## Selecting Element

Element selection can be performed for each display. Press the **ELEMENT** key located below each display to select a desired element. Elements are selected in the following sequence as the **ELEMENT** key is pressed. The default setting is "Element 1."

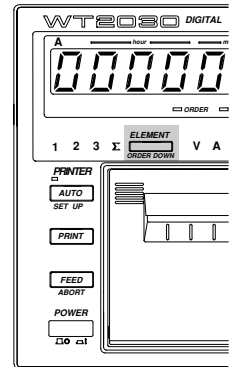
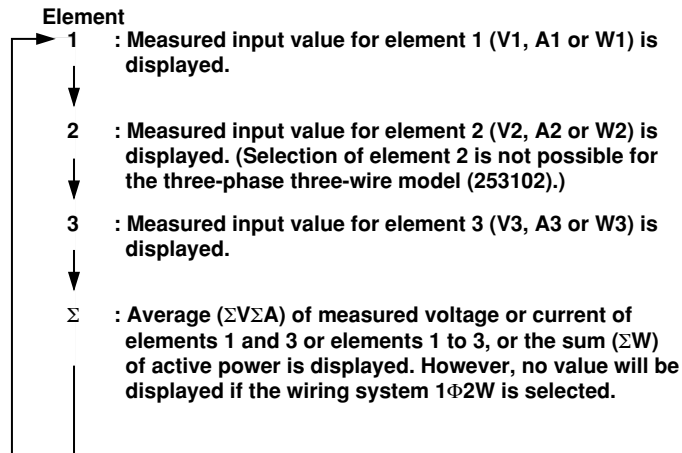

### Note

- Display A is shown in the above figure as an example. Selection of element is disregarded for some functions. In this case, changing the element will cause "E r r ! 5". Refer to Section 16, "Specifications" for the equation for each measurement item.

### Wiring System Selection and Selectable Measuring Objects (Elements)

The table below shows elements which can be measured with the wiring system selected with the **WIRING** key.

| Model  | Wiring System | Element           |
|--------|---------------|-------------------|
| 253102 | 1 $\Phi$ 2W   | 1, 3              |
|        | 1 $\Phi$ 3W   | 1, 3, $\Sigma$    |
|        | 3 $\Phi$ 3W   | 1, 3, $\Sigma$    |
| 253103 | 1 $\Phi$ 2W   | 1, 2, 3           |
|        | 1 $\Phi$ 3W   | 1, 2, 3, $\Sigma$ |
|        | 3 $\Phi$ 3W   | 1, 2, 3, $\Sigma$ |
|        | 3 $\Phi$ 4W   | 1, 2, 3, $\Sigma$ |
|        | 3V3A          | 1, 2, 3, $\Sigma$ |

## 3.3 Wiring the Measurement Circuit

The table below gives a list of wiring systems and their examples (diagrams) for each wiring system.

| Wiring System     | 1 $\Phi$ 2W                                | 1 $\Phi$ 3W | 3 $\Phi$ 3W | 3 $\Phi$ 4W | 3V3A     |          |
|-------------------|--|-------------|-------------|-------------|----------|----------|
| <b>WIRING</b> key | 1 $\Phi$ 2W                                | 1 $\Phi$ 3W | 3 $\Phi$ 3W | 3 $\Phi$ 4W | 3V3A     |          |
| Wiring Diagram    | When an input is applied directly          | Fig.3.1     | Fig.3.2     | Fig.3.3     | Fig.3.4  | Fig.3.5  |
|                   | When PT and CT are used (page 3-8)         | Fig.3.8     | Fig.3.9     | Fig.3.10    | Fig.3.11 | Fig.3.12 |
|                   | When an external shunt is used (page 3-10) | Fig.3.15    | Fig.3.16    | Fig.3.16    | Fig.3.17 | Omitted  |

### Wiring Method when Voltage and Current are Applied Directly

Fig. 3.1 Wiring Diagram for Single-Phase Two-Wire (1 $\Phi$ 2W)

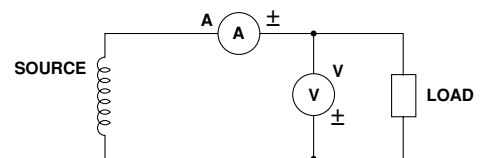
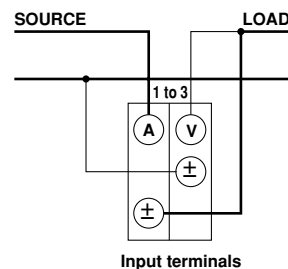
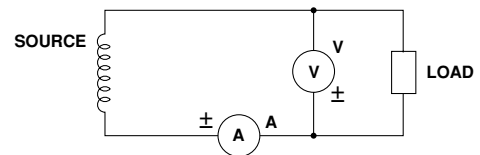
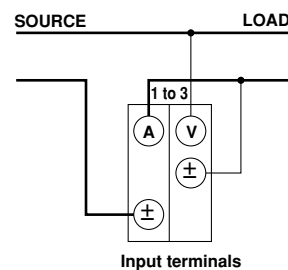
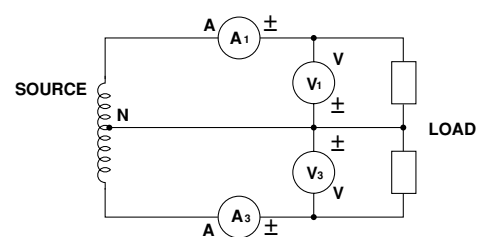
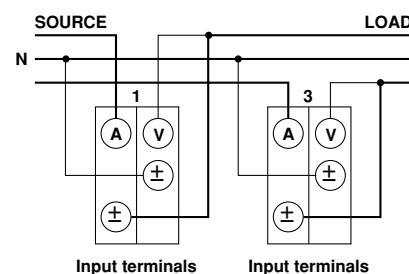

Fig. 3.2 Wiring Diagram for Single-Phase Three-Wire (1 $\Phi$ 3W)



#### ⚠ WARNING

When applying a current to be measured directly to the input terminals of the instrument, make sure that the external shunt cable is not connected to the instrument.

#### ⚠ CAUTION

A load current flows in the thick lines shown in the diagrams, therefore a wire with sufficient current capacity must be used for these lines. The wire connected from the source to the  $\pm$  current terminal must be routed as close as possible to the ground potential in order to minimize measurement error. (Refer to "Note" on page 3-6.)

Fig. 3.3 Wiring Diagram for Three-Phase Three-Wire (3 $\Phi$ 3W)

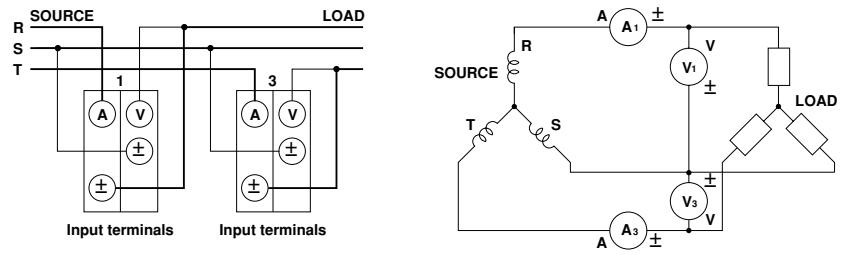

Fig. 3.4 Wiring Diagram for Three-Phase Four-Wire (3 $\Phi$ 4W)

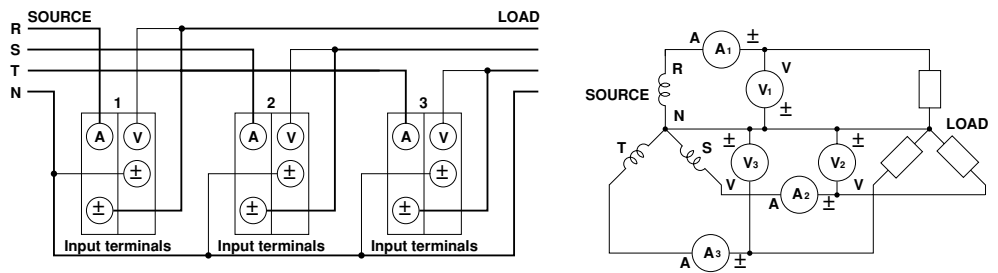
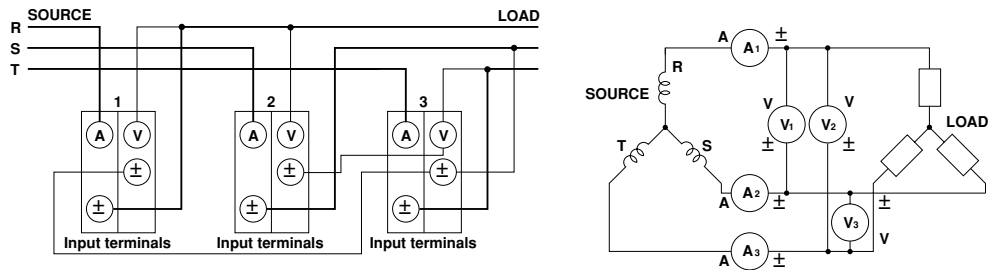

Fig. 3.5 Wiring Diagram for Three-Voltage Three-Current (3V3A)



### 3.3 Wiring the Measurement Circuit

**Note**

- The wire connected from the source to the  $\pm$  current terminal must be routed as close as possible to the ground potential in order to minimize measurement error. Fig. 3.6 shows the input circuit diagram of the instrument.

**Fig. 3.6 Input Circuit of the Instrument**

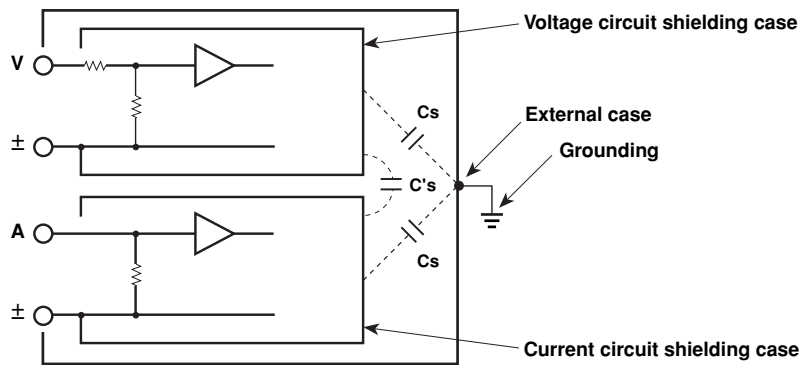

The voltage circuit is enclosed in its own shielding case, and the current circuit is also enclosed in its own shielding case. Both shielding cases are then enclosed in the external case. The voltage circuit shielding case is connected to the  $\pm$  voltage terminal, whilst the current circuit shielding case is connected to the  $\pm$  current terminal.

Although insulation is provided between the shielding cases as well as between the external case and each shielding case, stray capacitance  $C_s$  and  $C's$  are still present.  $C_s$  is approximately 100 pF. With power meters such as this instrument that are capable of measurement of current, voltage etc. of high frequency, these stray capacitance cannot be ignored as they cause measurement errors.

As an example, let's imagine the circuit shown in Fig. 3.7, where one end of the SOURCE (power source) and the external case are grounded. Current  $i_L$  from the power source enters the current terminal (A), passes the shunt, comes out from the current terminal ( $\pm$ ), then returns via the LOAD (load) to the power source, as indicated by the dotted line. The other route ( $i_{CS}$ ) is indicated by the dashed line; from the power source, through the shunt, stray capacitors, external case grounding, and power source grounding.

**Fig. 3.7**

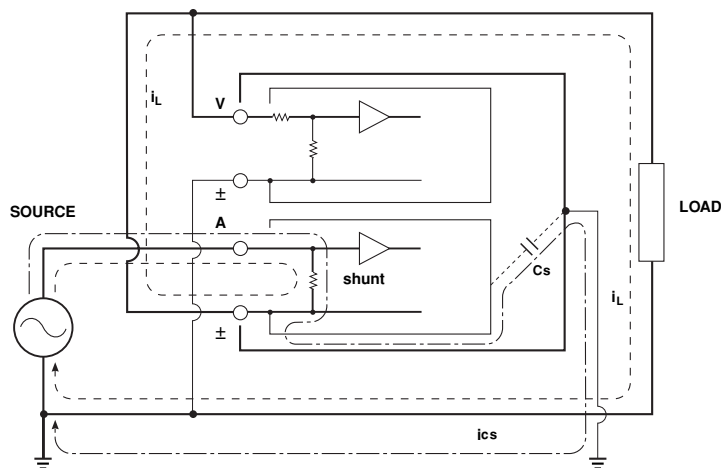

From this, it is obvious that the sum (vector sum) of the load current  $i_L$  and  $i_{CS}$ , which flows through the stray capacitors, is always measured even though we want to measure load the current  $i_L$  only. The current  $i_{CS}$ , which flows through the stray capacitor  $C_s$ , is calculated as follows.

Where, the common-mode voltage applied to  $C_s$  is  $V_{Cs}$

$$i_{CS} = V_{Cs} \times 2\pi f \times C_s$$

In the upper circuit shown in Fig. 3.1, no measurement error will occur since  $V_{Cs}$  is zero because both current terminal ( $\pm$ ) and voltage terminal ( $\pm$ ) are close to the ground potential. Effects of the stray capacitance are calculated below for reference.

$$C_s = 100\text{pF} = 100 \times 10^{-12}\text{F} = 10^{-10}\text{F}$$

Therefore,

$$\begin{aligned} i_{cs}[\text{A}] &= V_{Cs}[\text{V}] \times 2\pi f[\text{Hz}] \times C_s = V_{Cs} \times 2\pi f \times 10^{-10} \\ &= 2\pi \times 10^{-4} \times V_{Cs} \times f[\text{kHz}] [\text{mA}] \end{aligned}$$

Assuming  $f = 100\text{kHz}$ ,  $V_{Cs} = 100\text{V}$ ,  $i_{cs} \doteq 6.28\text{mA}$

If  $i_L = 1\text{A}$ , the current is expressed as a vector sum, as below, where the load consists of resistance only (i.e.  $\text{COS}\varphi = 1$ ),

$$\begin{aligned} |\vec{i}_L + \vec{i}_{cs}| &= \sqrt{1^2 + 0.00628^2} \\ &\doteq 1.00002 \end{aligned}$$

Therefore, the measurement error is 0.0002%, indicating that the effect on the measurement of the stray capacitance is very slight.

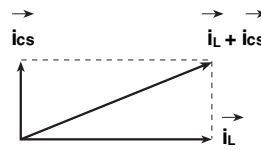

If  $\text{COS}\varphi = 0.5$ , the current can be obtained as follows.

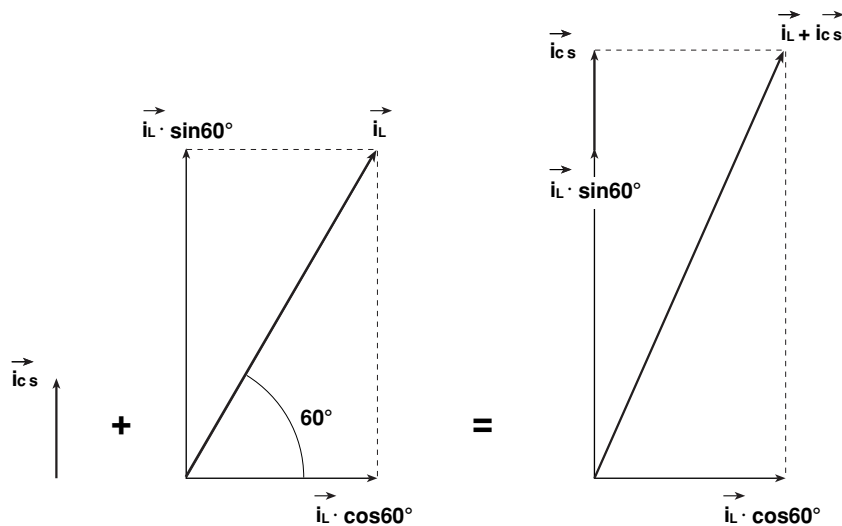

$$\begin{aligned} |\vec{i}_L + \vec{i}_{cs}| &= \sqrt{(i_L \cos 60^\circ)^2 + (i_{cs} + i_L \sin 60^\circ)^2} \\ &= \sqrt{(0.5)^2 + (0.00628 + 0.866)^2} \\ &\doteq 1.00542\text{A} \end{aligned}$$

Therefore, the measurement error is 0.542%.

If  $\text{COS}\varphi = 0$ ,  $i_L + i_{cs} = 1 + 0.00628 = 1.00628$ , therefore, the measurement error is 0.628%. Since active power is obtained using the equation  $W = VA \text{ COS}\varphi$ , the error is the same as that in the measurement of the current.

### Wiring Method when PT and CT are Used

Use of a PT (or CT) enables measurement of voltage or current even if the maximum voltage or maximum current of the object to be measured exceeds the maximum measuring range.

- If the maximum voltage of the object to be measured exceeds 600 V, connect an external potential transformer (PT), and connect the secondary side of the PT to the voltage input terminals.
- If the maximum current of the measuring object exceeds 30 A, connect an external current transformer (CT), and connect the secondary side of the CT to the current input terminals.

In the diagrams below, the thick lines represent the current circuit, and the thin lines represent the voltage circuit.

**Fig. 3.8 Wiring Example for Single-Phase Two-Wire (1Φ2W) System with PT and CT Connected**

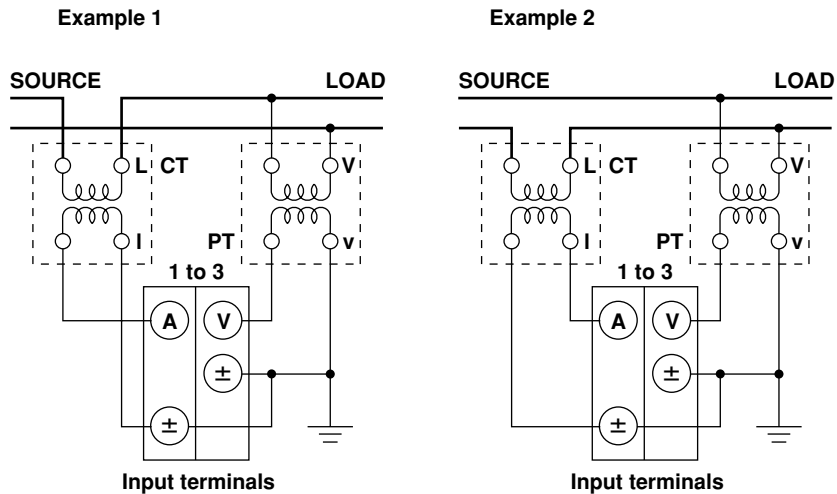

**Fig. 3.9 Wiring Example for Single-Phase, Three-Wire (1Φ3W) System with PT and CT Connected**

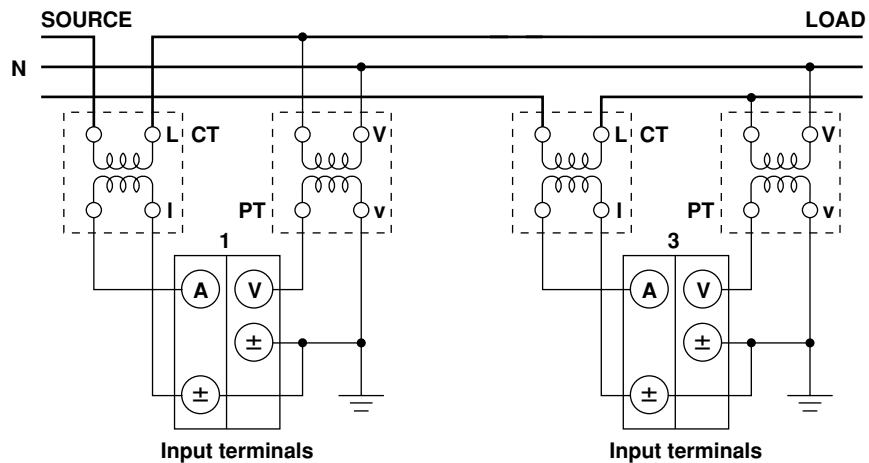

**WARNING**

When using an external CT, do not allow the secondary side of the CT to go open-circuit while power is supplied, otherwise an extremely dangerous high voltage will be generated on the secondary side of the CT.

**Note**

- Use of the scaling function enables direct reading of measured values on the display. For a description of how to set the scaling function, refer to Section 7.4 "Using the Scaling Function" (page 7-7).
- It must be noted that measured values are affected by the frequency and phase characteristics of PT and CT.

Fig. 3.10 Wiring Example for Three-Phase, Three-Wire (3Φ3W) System with PT and CT Connected

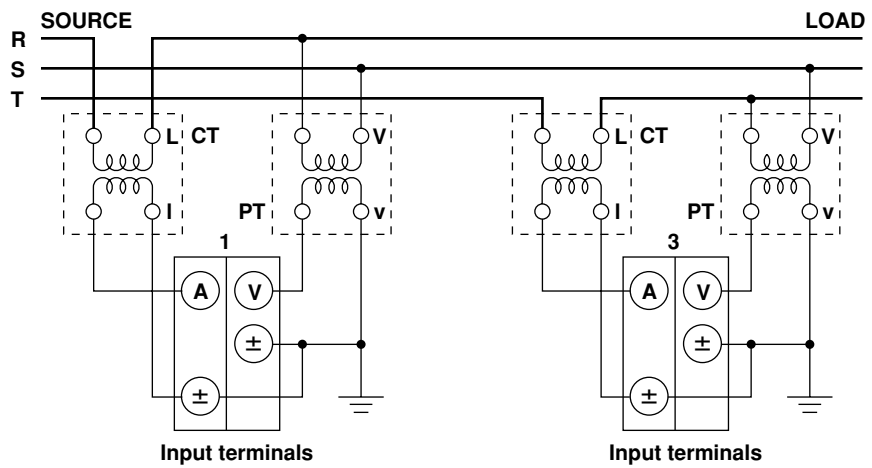

Fig. 3.11 Wiring Example for Three-Phase, Four-Wire (3Φ4W) System with PT and CT Connected

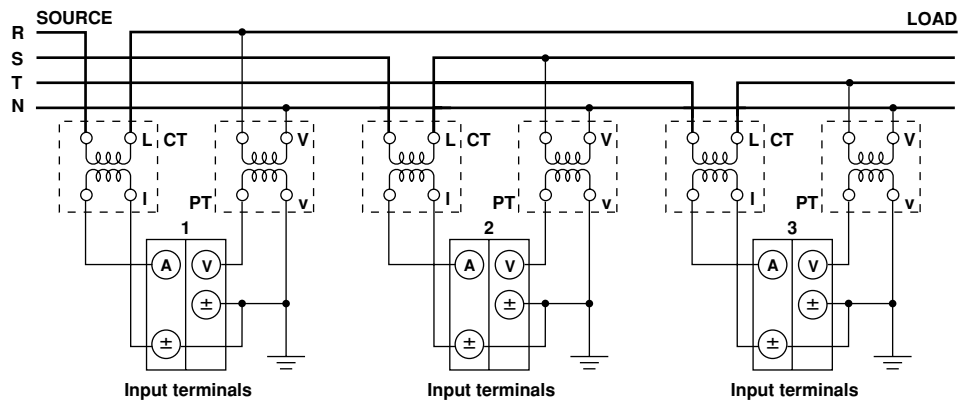
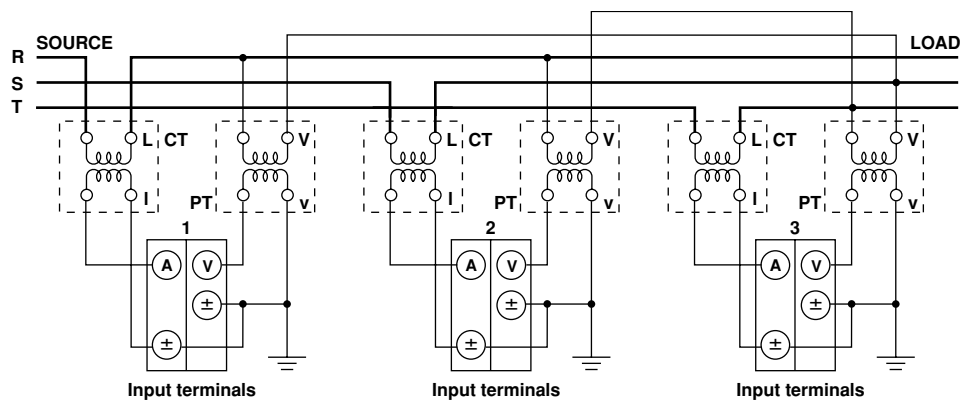

Fig. 3.12 Wiring Example for Three-Voltage, Three-Current (3V3A) System with PT and CT Connected



#### Wiring Method when External Shunt is Used

In cases where the maximum current of the object to be measured exceeds 30 A, connect a voltage-output type current shunt having the desired rated current to the external shunt input connector. The sensor must have appropriate frequency and phase characteristics.

#### Connecting an External Shunt to an External Shunt Input Cord

Connect the shielding wire of the cord to the output terminal (OUT L) of the shunt, as shown below, to minimize measurement error.

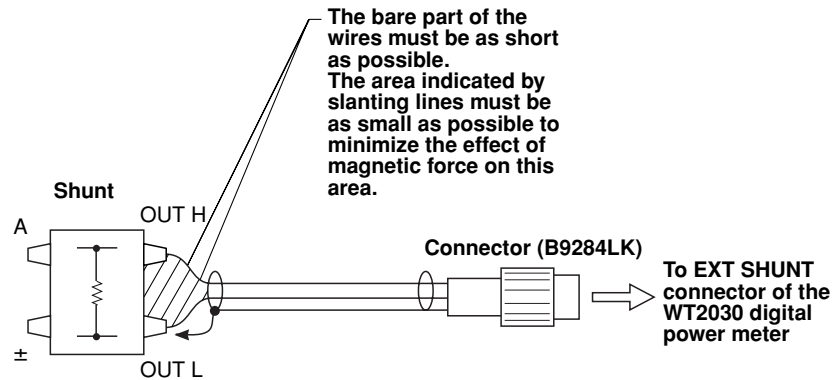

Since 50, 100 and 200 mV ranges are available for the external shunt, use an external shunt whose voltage drop matches these ranges. If an external shunt that does not match these ranges is used, convert the measured values on the display to input current values using the scaling function. Refer to Section “4.2 Setting Measuring Ranges” (page 4-4).



#### WARNING

- For safety, use an external shunt that is enclosed in a case and whose wires are isolated from the case. Also make sure that the shunt has a sufficient withstand voltage against the voltage to be measured. Use of a bare shunt may cause an electric shock if the shunt is touched accidentally.
- A voltage is present on the current terminal of the instrument while power is supplied to the measurement circuit, so the current terminal should never be touched nor should the measurement lead wire be connected to it.
- The connector to be connected to the external shunt input connector (EXT SHUNT) must be constructed in such a way that no lead wires are exposed. It is dangerous not to follow this instruction since a voltage is present on the lead wires while power is supplied to the measurement circuit.
- Do not connect anything to the input current terminals (A, ±) of the instrument, otherwise damage to the instrument or personnel injury may result.
- Before connecting an external shunt, make sure that the power to the shunt is turned OFF. A voltage is present on the external shunt while power is supplied to it, so do not touch the shunt with your hands.



**Note**

- The external shunt must be selected carefully and its frequency and phase characteristics taken into account.
- The external shunt must be wired so that the area between the wires connected to both ends of the shunt is minimized, in order to reduce the effect of the magnetic field generated by the current to be measured. Measurement is affected by magnetic field lines entering this area. Minimizing this area also reduces the effects of external noise.
- To avoid the effects of common-mode voltage, the external shunt must be connected to the grounding side of the power source.

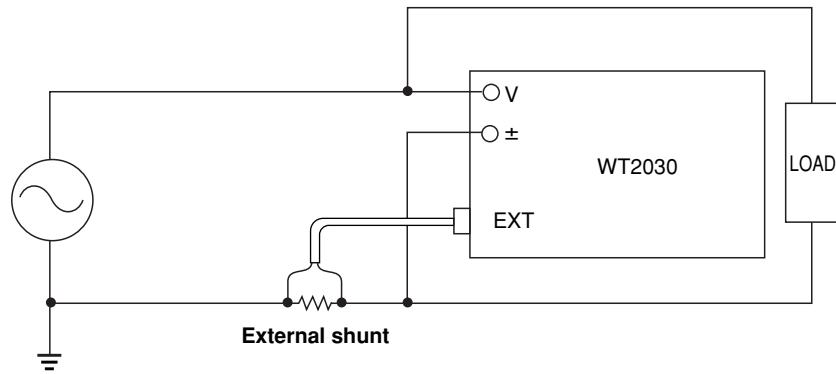
**Fig. 3.13**

- If the measuring object is high frequency and high power and is not grounded, the effects of inductance present on the shunt connecting cable will be increased. In this case, use an isolation sensor (CT, DC-CT, clamp).

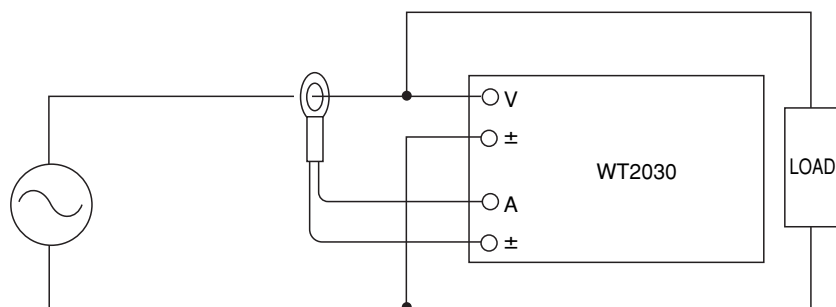
**Fig. 3.14**

- For safety, use a shunt that is enclosed in a case. Use of a bare shunt may cause an electric shock if the shunt is touched accidentally. If a case is provided separately, the case must have a sufficient withstand voltage against the voltages to be measured. However, this requirement does not need to be met if the shunt is connected to the grounding side of the power source as shown in Fig. 3.13, the single-phase, two-wire system.

Fig. 3.15 Wiring Example for Single-Phase, Two-Wire (1Φ2W) System with Shunt Connected

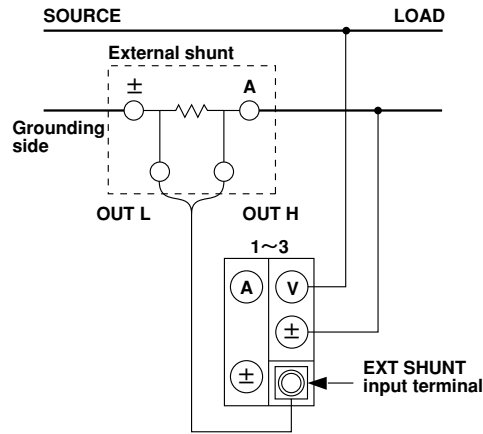

Fig. 3.16 Wiring Example for Single-Phase, Three-Wire (1Φ3W) or Three-Phase, Three-Wire (3Φ3W) System with Shunt Connected

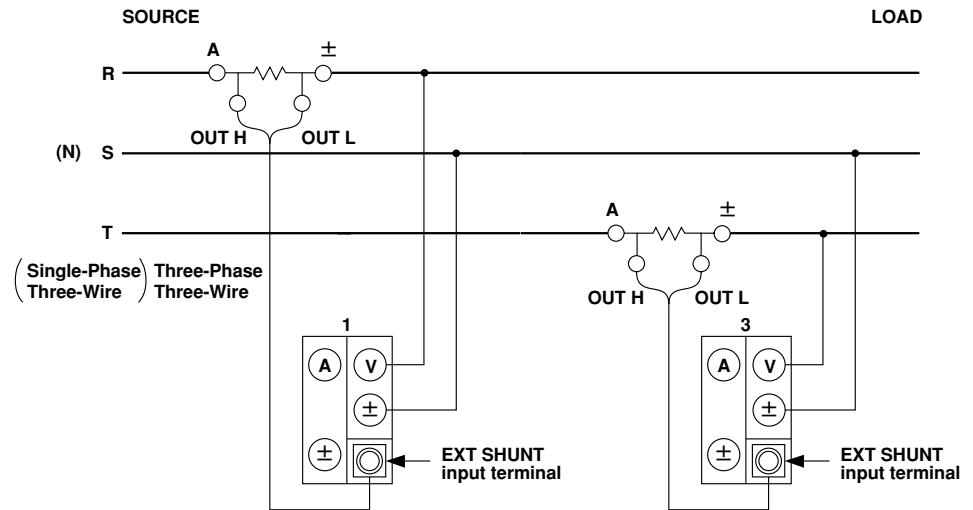
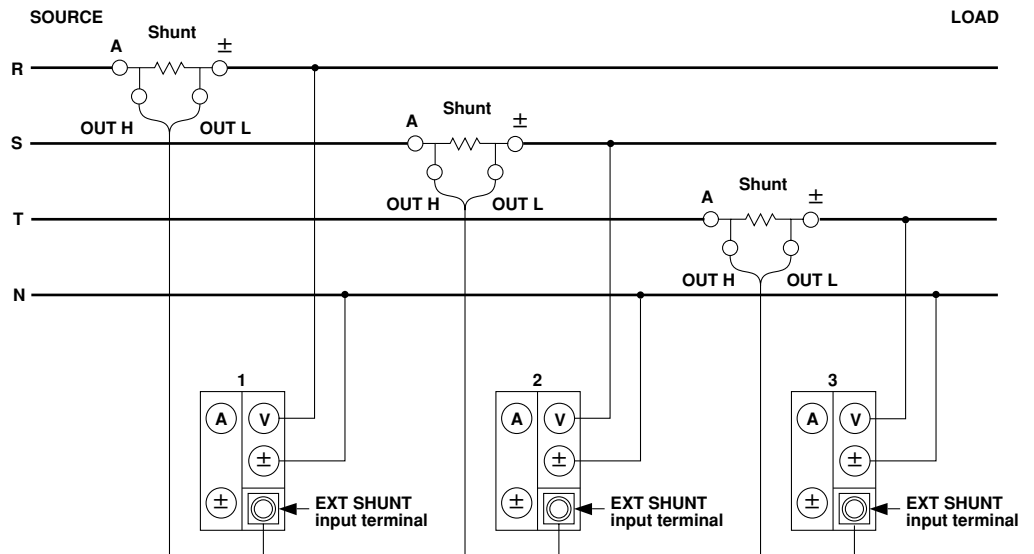

Fig. 3.17 Wiring Example for Three-Phase, Four-Wire (3Φ4W) System with Shunt Connected



## 3.4 Improving Measurement Accuracy

### Recommended Wiring Method

This instrument is designed so that voltage input impedance is high and current input impedance is low to reduce the effect of instrumental loss on measurement accuracy.

Voltage input impedance : Approximately  $2.4 \text{ M}\Omega$  (all ranges), with a capacitance of approximately  $13 \text{ pF}$  connected in parallel

Current input impedance : Approximately  $6 \text{ m}\Omega + 0.07 \text{ }\mu\text{H}$  (all ranges)

Fig. 3.18

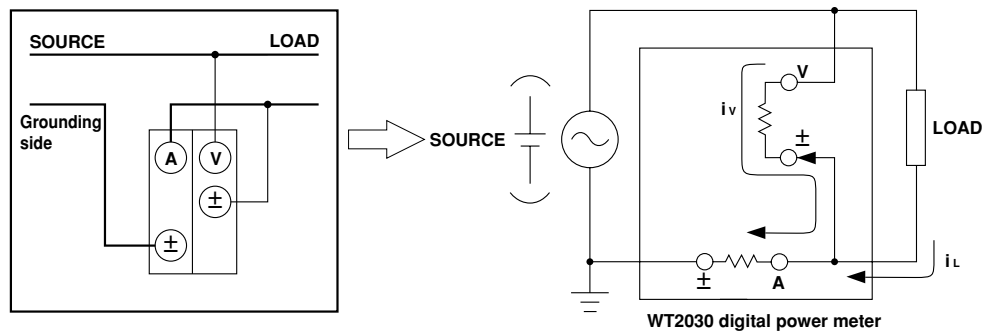

In the above diagram, the voltage measurement circuit is connected to the load side. The effects of instrumental loss on measurement accuracy are explained below. To simplify understanding, it is assumed that a DC power source and resistive load are used. The current measurement circuit measures the sum of the current  $i_L$  that flows to the load (object being measured) and the current  $i_V$  that flows to the voltage measurement circuit. This means that the current  $i_V$  is erroneous since the current to be measured is  $i_L$ . Since the input impedance of the voltage measurement circuit is high (approximately  $2.4 \text{ M}\Omega$ ), and even if the input voltage is  $600 \text{ V}$   $i_V$  becomes approximately  $0.25 \text{ mA}$  ( $=600 \text{ V}/2.4 \text{ M}\Omega$ ). If the instrumental error is assumed to be below  $0.1\%$ , the measured current ( $i_L$ ) will be  $250 \text{ mA}$  or higher (load resistance:  $2.4 \text{ }\Omega$  or lower). If the input voltage is  $10 \text{ V}$ ,  $i_L$  is  $4.2 \text{ mA}$  or higher. The relationship between the input voltage and the measured current in cases where instrumental error is within  $0.1\%$  and  $0.01\%$  is given on the next page as a reference.

Fig. 3.19 Effects of Instrumental Error

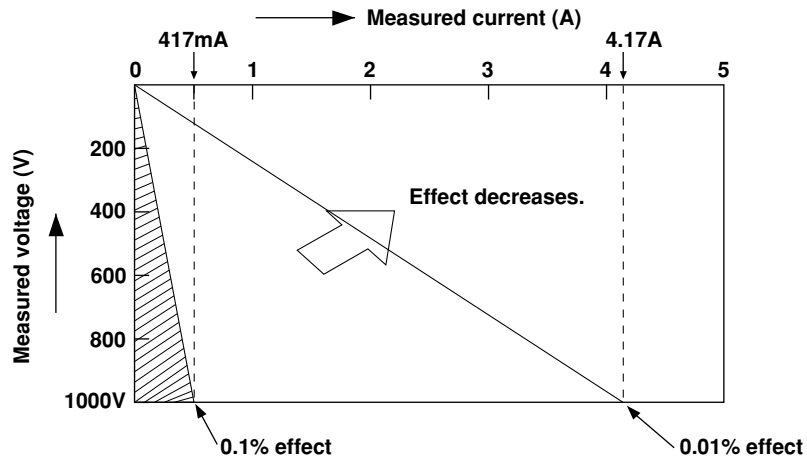

In many cases the recommended wiring method is suitable. For instance, when the input voltage and current are 100 V and 5 A,  $i_V$  is 0.04 mA ( $=100 \text{ V}/2.4 \text{ M}\Omega$ ), therefore the effect on measurement accuracy is 0.0008% ( $=0.04 \text{ mA}/5 \text{ A}$ ), which is low. On the other hand, measurement accuracy is significantly affected when the measured current is low (i.e. high load resistance). In this case, make the connections as follows so that the current measurement circuit is located on the load side. The voltage measurement circuit measures the sum of the voltage drop  $e_L$  at the load and  $e_A$  at the current measurement circuit, therefore  $e_A$  is erroneous. However, the effect of this error is small since the input impedance of the current measurement circuit is low. For instance, if the load resistance is 600  $\Omega$ , the input impedance is approximately 6 m $\Omega$ , therefore the error in measurement is approximately 0.001% ( $=e_A/(e_L + e_A)$ ), which is low.

Fig. 3.20

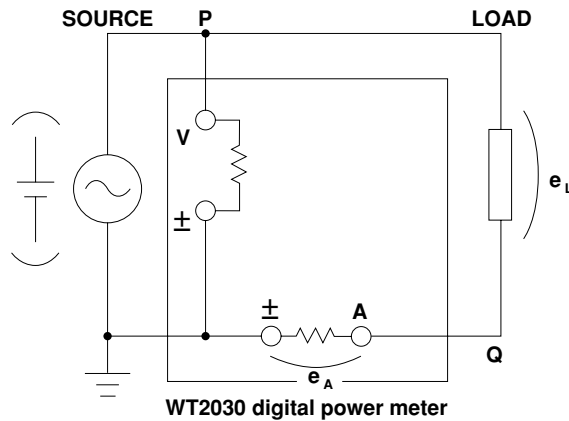

From the above explanation, it can be understood that the effect of instrumental loss on measurement accuracy can be reduced by wiring according to the load resistance.

# 3.5 Wiring System and Equations of Efficiency

Pay attention to the following when measuring efficiency. Measurement of efficiency is possible only with the following wiring systems. Make sure that the input element no. matches the affix no. (for instance, "1" of W1) of the variable used in the equation.

### Wiring Systems and Equations

#### Two-wire system for both input and output:

Select 1Φ2W, 1Φ3W or 3Φ3W (for 253102 only), or 1Φ2W or 3Φ3W (for 253103 only).

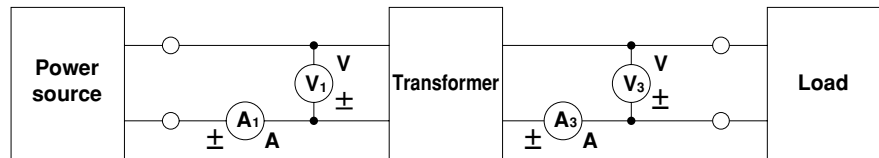

$$\text{Equation: } \eta = \frac{W3}{W1} \times 100(\%)$$

#### Single-phase for input and three-phase for output:

Select 1Φ3W, 3Φ3W, 3Φ4W or 3V3A. (Applicable only to 253103)

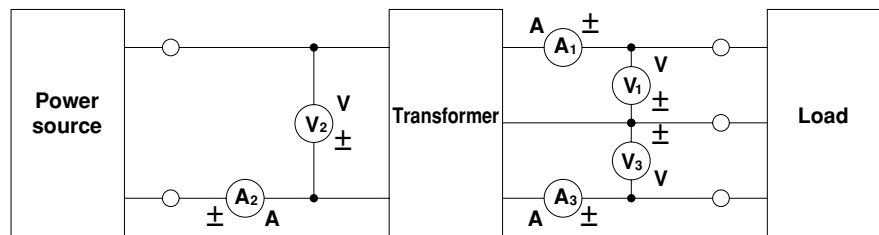

$$\text{Equation: } \eta = \frac{W1+W3}{W2} \times 100(\%)$$

### Measuring Efficiency Using the MATH Function

It is not possible to measure efficiency directly with the following wiring method. However, use of the MATH function (A ÷ B) enables computation of efficiency. For a description of how to set the MATH function, refer to Section 7.3, "Arithmetical Operations Using Display D" (page 7-4).

|           |           |                                      |
|-----------|-----------|--------------------------------------|
| Display A | Display B | Equation                             |
| W2        | ΣW        | $\eta = \frac{W2}{\frac{W2}{W1+W3}}$ |

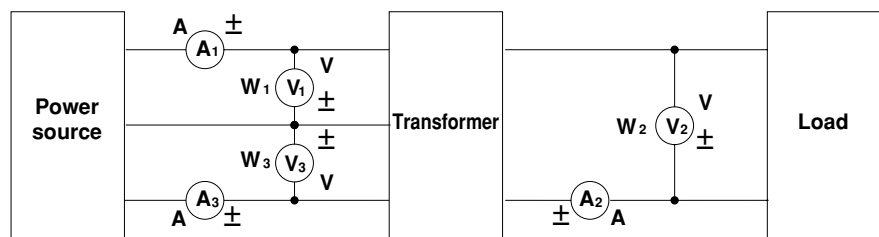

3Φ3W

### Note

- Refer to Section 7.1 "Measuring Efficiency" (page 7-1) for a description of the measurement method.
- The efficiency is not displayed as a percentage (%), but displayed as a value (1.0000 is equivalent to 100%) when the MATH function is used.

## 4.1 Setting Measuring Conditions

### Setting the Crest Factor

The crest factor for the input can be set to either “3” or “6” using the crest factor setting key.

#### To set the crest factor to “3”

Press the CF3 key (**SHIFT** + **∇**).

#### To set the crest factor to “6”

Press the CF6 key (**SHIFT** + **∧**).

The LED for the selected crest factor will light up.

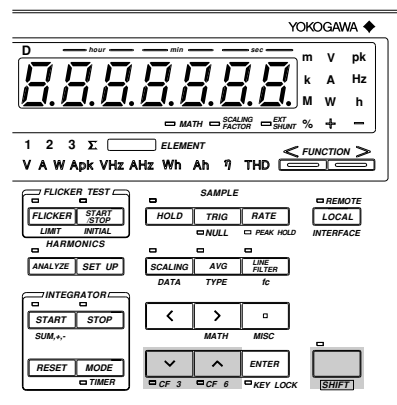

#### Note

- Measurement accuracy in the case of a crest factor of 6 will be 1.5 times the range error for a crest factor 3.
- The crest factor cannot be changed while integration or measurement of voltage fluctuation/flicker is in progress or when it has been interrupted.

### Measuring with Line Filter ON

Use of a line filter during normal measurement of PWM waveforms, such as inverter waveforms, has the following advantages.

- In the case of measurement of voltage and current, similar results to those obtained in the measurement of fundamental waveforms can be obtained. Measured values are also the same as those obtained in the MEAN measurement mode.
- In the case of measurement of power, similar results to those obtained in the measurement of fundamental waveforms can also be obtained.

It is also possible to select cut-off frequency suitable for the fundamental component of the waveform to be measured.

- A 5th order butterworth lowpass filter is used.

#### Setting the Cut-off Frequency

1. Press the **fc** key (**SHIFT** + **LINE FILTER**).  
Display C displays " $F_c$ " and display D displays the currently selected cut-off frequency.

2. The cut-off frequency on display D changes in the following order each time the **∧** key is pressed, so select the desired cut-off frequency.

0.500 → 5.500 → 0.500 → . . .

Pressing the **∇** key causes the cut-off frequency to change in the opposite order. The cut-off frequency is displayed in units of kHz. The default is 0.500.

3. Press the **ENTER** key.

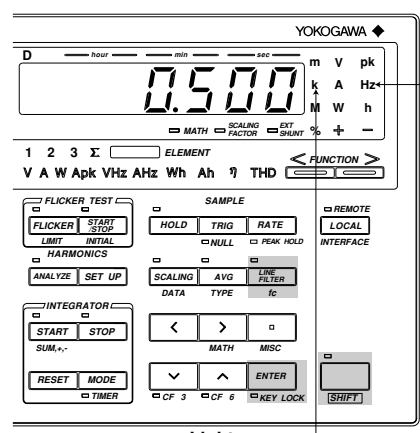

Lights up.

#### Turning Filter ON or OFF

Press the **LINE FILTER** key. The LED above the **LINE FILTER** key is lit when the filter is ON.

#### Note

- The line filter cannot be turned ON and OFF during integration
- Pressing the **LINE FILTER** key during harmonic analysis will allow you to turn the anti-aliasing filter ON and OFF. The cut-off frequency of the anti-aliasing filter is 5.5 kHz.

### Setting the Display Update Cycle (Sample Rate)

1. Press the **RATE** key. Display C displays "5 - r Hz E" and display D displays the currently selected sample rate.
2. The sample rate on display D changes in the following order each time the **^** key is pressed, so select the desired sample rate.  
 0.500 (500 ms) → 2.000 (2 s) → 0.250 (250 ms) → 0.500 → ...  
 Pressing the **v** key causes the sample rate to change in the opposite order

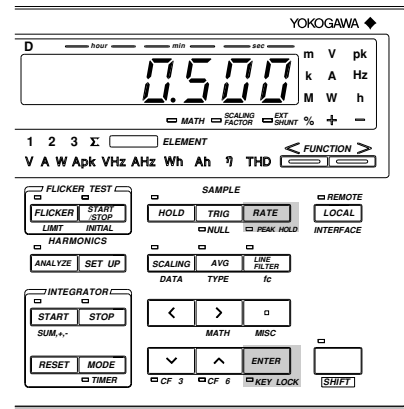

| Sample Rate                       | Lower Limit Frequency<br>(for Measurement of V, A and W) | Frequency Range   |
|-----------------------------------|--|-------------------|
| 250ms                             | 20Hz   | 20Hz ≤ f ≤ 1MHz   |
| 500ms                             | 10Hz   | 10Hz ≤ f ≤ 500kHz |
| 2s                                | 2Hz  | 2Hz ≤ f ≤ 100kHz  |
| Default setting is 0.500 (500 ms) |  |                   |

3. Press the **ENTER** key.

**Note**

- The sample rate is fixed at 2 seconds during integration and measurement of voltage fluctuation/flicker.

### Display and Data Output

#### Holding Display and Output

To hold the currently displayed measured values, press the **HOLD** key. The LED above the **HOLD** key will light up, indicating that the hold function is currently on. Pressing the **HOLD** key again causes the LED to go out, indicating that the hold function is now off.

#### Updating the Data during Hold Mode

Pressing the **TRIG** key while the HOLD indicator LED is lit will update the measured values. The measured values are also updated when the external trigger signal is received.

If the measured values are output (by means of a communications channel or the D/A converter), the output values are also updated when the **TRIG** key is pressed.

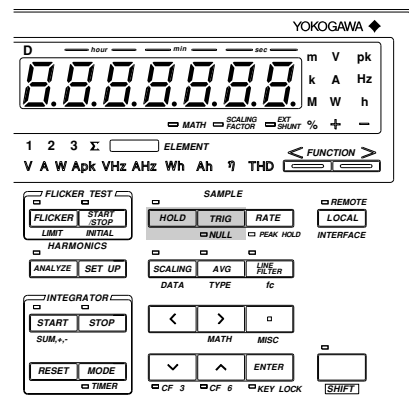

### Voltage and Current Measurement Modes

One of the following measurement modes can be selected for measurement of voltage and current.

- RMS : Measures and displays true rms value.
- MEAN : Displays rectified mean value calibrated to the rms value.
- DC : Displays DC value obtained by averaging the input signal.

The default setting for measurement mode is RMS.

**RMS**

This mode is used to display input voltage or current as a true rms value. The theoretical equation is given below.

$$\sqrt{\frac{1}{T} \int_0^T f(t)^2 dt}$$

f(t) : Input signal  
 T : One period of the input signal

**MEAN**

This mode is used to display input voltage or current as a rectified mean value calibrated to the rms value. Since a sine wave is used for calibration, the value displayed will be the same as that obtained in RMS mode if a sine wave is measured. However, the value displayed will be different from that obtained in RMS mode if a distorted or DC waveform is measured. The theoretical equation is given below.

$$\frac{\pi}{2\sqrt{2}} \cdot \frac{2}{T} \int_0^{\frac{T}{2}} |f(t)| dt$$

f(t) : Input signal  
T : One period of the input signal

**DC**

This mode is used when the input voltage or current is DC. The input signal is averaged and the result is displayed.

**Typical Waveform Types and Differences in Measured Values Between Measurement Modes**

| Name                           | Waveform | Measurement mode                                 |                               |   |                               |
|--------------------------------|----------|--|-------------------------------|---|-------------------------------|
|                                |          | rms value  | Mean value                    | Mean-value rectification                        | Linear averaging              |
|                                |          | RMS  | —                             | MEAN  | DC                            |
| <b>Sine Wave</b>               |          | $\frac{E_p}{\sqrt{2}}$                           | $\frac{2}{\pi} \cdot E_p$     | $\frac{E_p}{\sqrt{2}}$                          | 0                             |
| <b>Half-wave rectification</b> |          | $\frac{E_p}{2}$                                  | $\frac{E_p}{\pi}$             | $\frac{E_p}{2\sqrt{2}}$                         | $\frac{E_p}{\pi}$             |
| <b>Full-wave rectification</b> |          | $\frac{E_p}{\sqrt{2}}$                           | $\frac{2}{\pi} \cdot E_p$     | $\frac{E_p}{\sqrt{2}}$                          | $\frac{2}{\pi} \cdot E_p$     |
| <b>Direct current</b>          |          | $E_p$  | $E_p$                         | $\frac{\pi}{2\sqrt{2}} \cdot E_p$               | $E_p$                         |
| <b>Triangular wave</b>         |          | $\frac{E_p}{\sqrt{3}}$                           | $\frac{E_p}{2}$               | $\frac{\pi}{4\sqrt{2}} \cdot E_p$               | 0                             |
| <b>Square wave</b>             |          | $E_p$  | $E_p$                         | $\frac{\pi}{2\sqrt{2}} \cdot E_p$               | 0                             |
| <b>Pulse</b>                   |          | $\sqrt{\frac{\tau}{2\pi}} \cdot E_p$             | $\frac{\tau}{2\pi} \cdot E_p$ | $\frac{\pi \cdot \tau}{4\pi\sqrt{2}} \cdot E_p$ | $\frac{\tau}{2\pi} \cdot E_p$ |
|                                |          | When duty D (= $\frac{\tau}{2\pi}$ ) is applied: |                               |   |                               |
|                                |          | $\sqrt{D} \cdot E_p$                             | $D \cdot E_p$                 | $\frac{\pi \cdot D}{2\sqrt{2}} \cdot E_p$       | $D \cdot E_p$                 |



## 4.2 Setting Measuring Ranges

### Setting Voltage/Current Measuring Ranges for Each Element

Voltage and current measuring range can be set for each element.

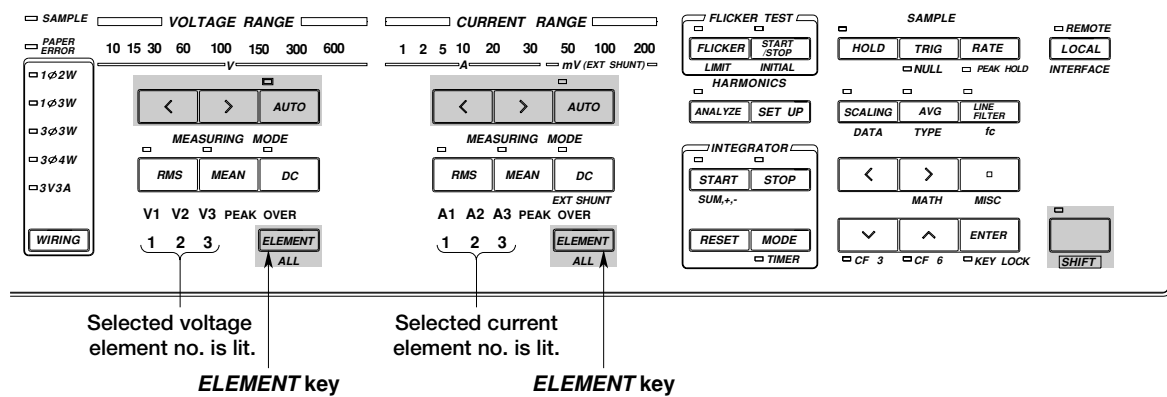

### Setting the Measuring Range for Each Element

1. Keep pressing the **ELEMENT** key until the desired element no. lights up.
2. Press the range setting key (<, > or **AUTO**) to set the desired measuring range.
3. Repeat steps 1 and 2 to set the desired measuring range for other elements.

### Setting the Same Measuring Range for All Elements at Once

To set the same measuring range for all elements at once, carry out the following steps.

1. Press the **ALL** key (**SHIFT** + **ELEMENT**).  
All element nos. will light up.
2. Press the range setting key (<, > or **AUTO**) to set the desired measuring range.

## Manual and Auto Range Setting

### Measuring Range Setting Method

There are two methods of setting the measuring range; auto range setting, in which the most suitable range is selected automatically, and manual range setting, in which the range is selected manually.

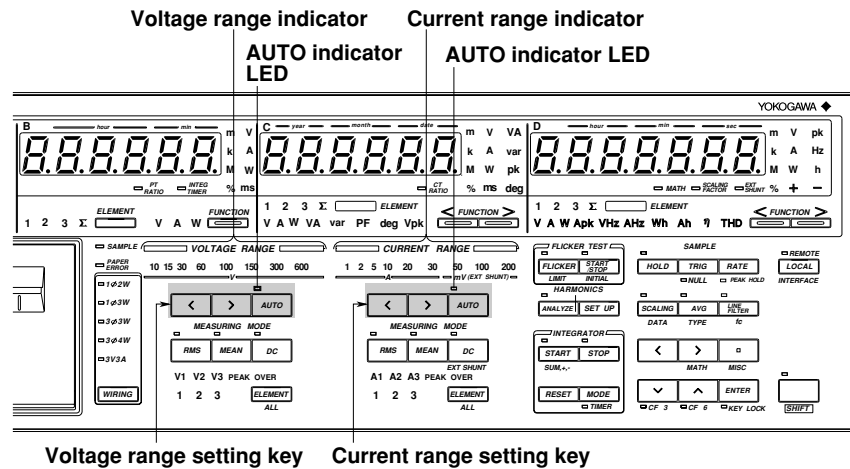

Voltage range setting key    Current range setting key

### Manual Range Setting

When the AUTO indicator LED is not lit, manual range setting mode is valid. In this mode, the next lowest or highest range can be selected manually by pressing the < or > key respectively. If the AUTO indicator LED is lit, press the < or > key. This will cause the AUTO indicator LED to go out, indicating that manual range setting mode is valid.

### Auto Range Setting

When the AUTO indicator LED is lit, auto range setting mode is valid. The measuring range is switched automatically according to the input voltage or current.

**Range Up** : A higher range is selected immediately if the instantaneous input voltage or current exceeds approximately 350% of the rated value (or approximately 700% if the crest factor is 6) during sampling. If the measured voltage or current exceeds 110% of the rated value, or if an over range for the measured value occurs during harmonic analysis, a higher range will be selected at the end of the current measurement cycle (i.e. at the next update).

**Range Down** : A lower range is selected if the measured voltage or current drops below 30% of the rated value.

### Switching from Auto Range Setting to Manual Range Setting (when the AUTO Indicator LED is Lit)

Switching to manual range setting can be performed using one of the following procedures. Procedure

- Press the < or > key.

The AUTO indicator LED will go out, and manual range setting mode becomes valid. The next highest or lowest range relative to the range set in auto range setting mode will be selected.

- Press the **AUTO** key.

The AUTO indicator LED will go out and manual range setting mode becomes valid.

### Note

- In auto range setting mode, the range may be switched frequently if a waveform such as a pulse, which has a high crest factor, is input. In this case, set the range manually.
- "-----" will be displayed if no measured data is present, measuring range will not be selected automatically even if auto range setting mode is selected.
- If the measuring range is changed during harmonic analysis, PPL synchronization will be disabled, then re-enabled. As a result no correct measured value will be obtained, therefore the measuring range changes all the time. In this case, carry out measurement in manual range setting mode.
- Auto range will be canceled automatically when the measurement mode is switched to voltage fluctuation/flicker measurement mode.
- Refer to Section 16, "Specifications", for measurement accuracy.

### Display Resolution and Power Range

The measuring range for active power, apparent power and reactive power is determined as follows.

| Wiring System                   | Power Range  |
|---------------------------------|--|
| Single-phase, two-wire (1Φ2W)   | Voltage range x Current range  |
| Single-phase, three-wire (1Φ3W) | Voltage range x Current range x 2  |
| Three-phase, three-wire (3Φ3W)  | (When the same voltage and current measuring ranges are used for all elements) |
| Three power meter method (3V3A) |  |
| Three-phase, four-wire (3Φ4W)   | Voltage range x Current range x 3  |
|                                 | (When the same voltage and current measuring ranges are used for all elements) |

Display resolution is given below, based on the above specifications.

1. The lowest display digit will not be used when the frequency exceeds 199999 counts or when computed result or efficiency exceeds 50000 counts.
2. If the crest factor is 6, the lowest digit will not be used when the computed result or efficiency exceeds 10000 counts.
3. When the voltage range x current range exceeds 1000 W, the display unit will switch to "kW", and when it exceeds 1000 kW, the display unit will switch to "MW".

**Note**

- In auto range setting mode, the measuring range switches according to range up/range down conditions as described on page 4-5. Therefore, the range may vary even if the measured values remain the same.

The decimal point position and unit for voltage, current and power are shown below in the case of direct input range. ΣW indicates that the same voltage and current ranges are used for all the input elements.

W for 1Φ2W System

|               |         | Current Range |          |          |          |          |          |
|---------------|---------|---------------|----------|----------|----------|----------|----------|
|               |         | 1.0000A       | 2.0000A  | 5.000A   | 10.000A  | 20.000A  | 30.000A  |
| Voltage Range | 10.000V | 10.000W       | 20.000W  | 50.000W  | 100.00W  | 200.00W  | 300.00W  |
|               | 15.000V | 15.000W       | 30.000W  | 75.00W   | 150.00W  | 300.00W  | 45.000W  |
|               | 30.000V | 30.000W       | 60.00W   | 150.00W  | 300.00W  | 600.0W   | 90.00W   |
|               | 60.00V  | 60.00W        | 120.00W  | 300.00W  | 600.0W   | 1.2000kW | 180.00W  |
|               | 100.00V | 100.00W       | 200.00W  | 500.00W  | 1.0000kW | 2.0000kW | 3.0000kW |
|               | 150.00V | 150.00W       | 300.00W  | 750.0W   | 1.5000kW | 3.0000kW | 4.5000kW |
|               | 300.00V | 300.00W       | 600.0W   | 1.5000kW | 3.0000kW | 6.000kW  | 9.000kW  |
|               | 600.0V  | 600.0W        | 1.2000kW | 3.0000kW | 6.000kW  | 12.000kW | 18.000kW |

ΣW for 1Φ3W, 3Φ3W and 3V3A Systems

|               |         | Current Range |          |          |          |          |          |
|---------------|---------|---------------|----------|----------|----------|----------|----------|
|               |         | 1.0000A       | 2.0000A  | 5.000A   | 10.000A  | 20.000A  | 30.000A  |
| Voltage Range | 10.000V | 20.000W       | 40.000W  | 100.00W  | 200.00W  | 400.00W  | 600.0W   |
|               | 15.000V | 30.000W       | 60.00W   | 150.00W  | 300.00W  | 600.0W   | 90.00W   |
|               | 30.000V | 60.00W        | 120.00W  | 300.00W  | 600.0W   | 1.2000kW | 180.00W  |
|               | 60.00V  | 120.00W       | 240.00W  | 600.0W   | 1.2000kW | 2.4000kW | 360.00W  |
|               | 100.00V | 200.00W       | 400.00W  | 1.0000kW | 2.0000kW | 4.0000kW | 600.0W   |
|               | 150.00V | 300.00W       | 600.0W   | 1.5000kW | 3.0000kW | 6.000kW  | 900.0W   |
|               | 300.00V | 600.0W        | 1.2000kW | 3.0000kW | 6.000kW  | 12.000kW | 1.8000kW |
|               | 600.0V  | 1.2000kW      | 2.4000kW | 6.000kW  | 12.000kW | 24.000kW | 3.6000kW |

ΣW for 3Φ4W System

|               |         | Current Range |          |          |          |          |          |
|---------------|---------|---------------|----------|----------|----------|----------|----------|
|               |         | 1.0000A       | 2.0000A  | 5.000A   | 10.000A  | 20.000A  | 30.000A  |
| Voltage Range | 10.000V | 30.000W       | 60.00W   | 150.00W  | 300.00W  | 600.0W   | 900.0W   |
|               | 15.000V | 45.000W       | 90.00W   | 225.00W  | 450.00W  | 900.0W   | 1.3500kW |
|               | 30.000V | 90.00W        | 180.00W  | 450.00W  | 900.0W   | 1.8000kW | 2.7000kW |
|               | 60.00V  | 180.00W       | 360.00W  | 900.0W   | 1.8000kW | 3.6000kW | 5.400kW  |
|               | 100.00V | 300.00W       | 600.0W   | 1.5000kW | 3.0000kW | 6.000kW  | 9.000kW  |
|               | 150.00V | 450.00W       | 900.0W   | 2.2500kW | 4.5000kW | 9.000kW  | 13.500kW |
|               | 300.00V | 900.0W        | 1.8000kW | 4.5000kW | 9.000kW  | 18.000kW | 27.000kW |
|               | 600.0V  | 1.8000kW      | 3.6000kW | 9.000kW  | 18.000kW | 36.000kW | 54.00kW  |

## Measuring Range for External Shunt

### Scaling Function

The maximum current measuring range of this instrument is 30 A.

If the current to be measured is higher than this maximum, an external shunt can be used. Use of the scaling function enables direct reading of the measured value.

| Display Item   | Measured/Computed Value | Scaled Value |
|----------------|-------------------------|--------------|
| Current        | A                       | Ks x A       |
| Active power   | W                       | Ks x W       |
| Reactive power | var                     | Ks x var     |
| Apparent power | VA                      | Ks x VA      |

Ks: External shunt scaling value

### Setting Measuring Range

1. Press the < or > key to select the measuring range (50, 100 or 200 mV).

### Setting External Shunt Scaling Value

1. Press the **EXT SHUNT** key (**SHIFT + DC**). “ $\xi h u n t$ ” will be displayed on display A. The element currently selected is displayed on display C. Press the  $\wedge$  or  $\vee$  key until the desired element is displayed on display C.

The display changes in the order of  $\# L L$  (all elements)  $\rightarrow$   $E L 1$  (element 1)  $\rightarrow$   $E L 2$  (element 2, applicable only for the 253103)  $\rightarrow$   $E L 3$  (element 3)  $\rightarrow$   $E n d$  (to end making setting) and back to  $\# L L$ .

After the element has been set, press the **ENTER** key.

Display D displays the external shunt scaling value for the element which is currently selected for display C, with the digit on the extreme left blinking.

2. Shifting the blinking position

The blinking position can be shifted to the left or right by pressing the < or > key respectively.

3. Setting a value

To set the value of the blinking digit, press the  $\wedge$  or  $\vee$  key.

Pressing the  $\wedge$  key changes the value in the order 1, 2, 3 ... 9, 0 and back to 1.

Pressing the  $\vee$  key changes the value in the opposite direction.

Default scaling value: 50.000

Minimum scaling value: 0.0200

Maximum scaling value: 1000.0

4. Shifting the decimal point position

The decimal point can be shifted by pressing the key.

5. After the scaling value has been set, press the **ENTER** key.

6. The next element is now displayed on display C. Repeat steps 2 to 5.

7. To exit from setting mode, select “ $E n d$ ” on display C and then press the **ENTER** key. To exit from setting mode in the middle of making settings, press the **SHIFT** key or **DC (EXT SHUNT)** key.

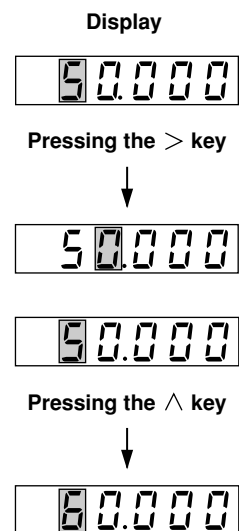

### Setting Example for External Shunt Scaling Value

**When the external shunt range is 50 mV and the following shunt is used**

Shunt used: 100 A/100 mV

Set the scaling value to "50.000".

**When the secondary-side rating of the external shunt is not 50 mV, 100 mV or 200 mV**

This problem can be solved by using the scaling function. An example is given below.

When a shunt with a rating of 50 A/60 mV is used:

$(50/60 \text{ mV}) \times 50 \text{ mV (setting range)} = 41.666\dots$

From the above calculation, set the scaling value to "41.667".

Since the measuring range is 50 mV, make sure that the input is within the range 0 to 50 mV.

### Note

---

- If an attempt is made to set a scaling value that is outside the setting range, error code "Err 12" is displayed. In this case, re-enter the correct value.
  - To read the measured value directly when an external shunt is being used, **SCALING** must be set to OFF. If SCALING is ON, the measured value will be further multiplied by the CT ratio (scaling value for current) before it is displayed.
  - If the **ENTER** key is pressed while "Err 12" is displayed on display C, the value displayed on display D will be set to the shunt scaling value for all elements.
-

## 4.3 Selecting What to Display on Digital Displays

The instrument has four digital displays as shown below. The information to be displayed on each display can be selected with the **FUNCTION** key and **ELEMENT** key below the display. Each display has its own **FUNCTION** key and **ELEMENT** key.

The specific type of information to be displayed is shifted upwards each time the **FUNCTION** key is pressed.

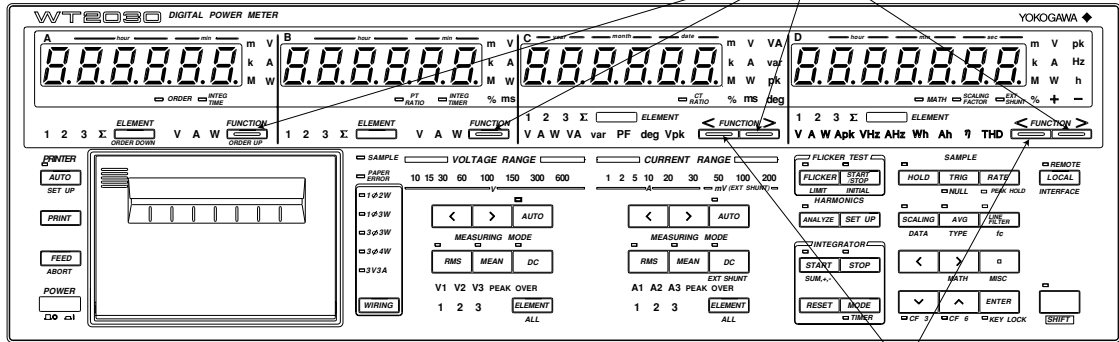

The specific type of information to be displayed is shifted downwards each time the **FUNCTION** key is pressed.

### Operating the FUNCTION Key

Pressing the **FUNCTION** key switches the display in the following order. In the case of displays C and D (refer to next page), the sequence below shows the order in which the display information type is switched when the right-side **FUNCTION** key is pressed. Pressing the left-side **FUNCTION** key switches display information type in the opposite order.

#### Display A

Default setting for display A is "V" (voltage).

The harmonic order is displayed during harmonic analysis.

V (voltage) → A (current) → W (active power) → INTEG TIME (integration time)



#### Display B

Default setting for display B is "A" (current).

V (voltage) → A (current) → W (active power)



**Display C**

Default setting for display C is "W" (power).

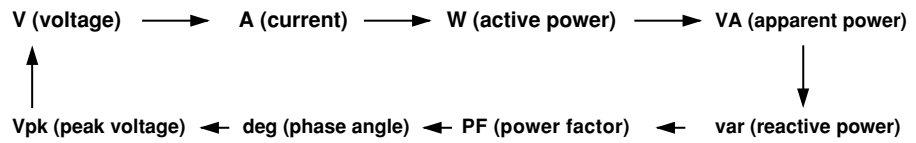

• During harmonic analysis

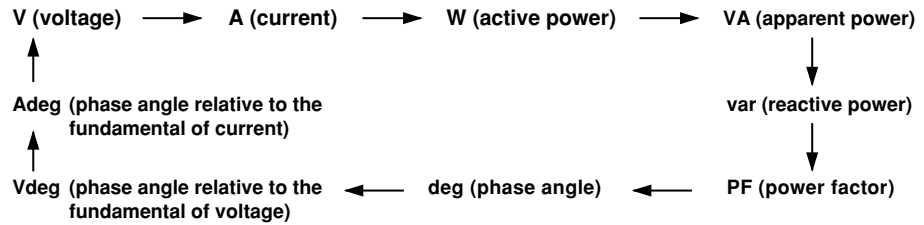

**Display D**

Default setting for display D is "W" (power).

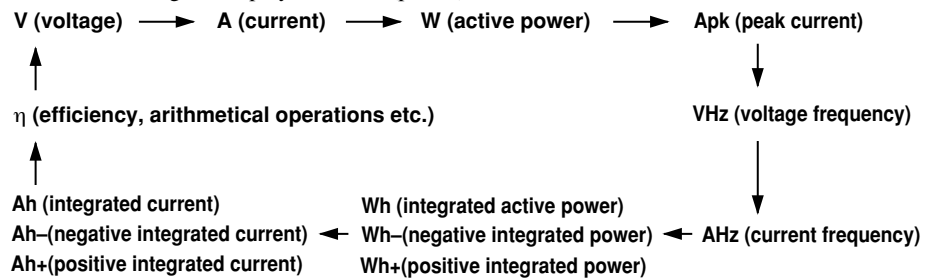

• During harmonic analysis

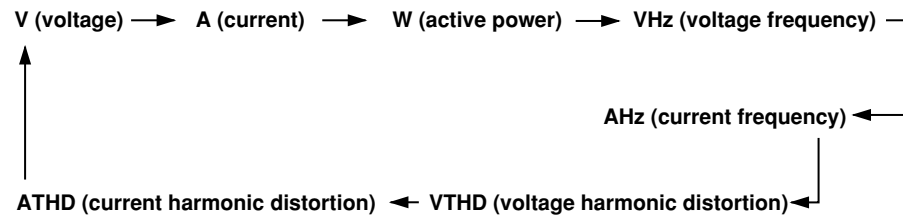

# 5.1 Measuring Voltage, Current and Active Power

## Selecting What to Display and Element to be Measured

1. Select **V** (voltage measurement) , **A** (current measurement) or **W** (active power measurement) by pressing the **FUNCTION** key for the display on which the measured value is to be displayed. For details, refer to Section 4.3 "Selecting What to Display on Digital Displays " (page 4-9).
2. Press the **ELEMENT** key below the same display to select the element to be measured. For details, refer to Sections 3.2 "Setting Wiring System" (page 3-2) and 4.2 "Setting Measuring Ranges" (page 4-4).

## Setting Measuring Ranges

3. Press the voltage range or current range setting key to set the desired measuring range. For details, refer to 4.2 "Setting Measuring Ranges" (page 4-5).

## Setting Voltage/Current Measurement Mode (RMS, MEAN or DC)

4. Press the measurement mode setting key (RMS, MEAN or DC key) to set the desired measurement mode. For details, refer to Section 4.1 "Setting Measuring Conditions" (page 4-2).

## Power Range

- The power measuring range is determined according to the selected voltage and current ranges. For details, refer to Section 4.2 "Setting Measuring Ranges" (page 4-6).
- For power measuring range, refer to Section 16. "Specifications."



## 5.2 Measuring Peak Voltage and Current

Measured peak voltage is displayed on display C, whilst measured peak current is displayed on display D.

### Setting Element to be Measured

1. Select **Vpk (peak voltage)** by pressing the **FUNCTION** key below display C, and select **Apk (peak current)** by pressing the **FUNCTION** key below display D. For details, refer to Section 4.3 "Selecting What to Display on Digital Displays" (page 4-9).
2. Press the **ELEMENT** key below the same display to select the element to be measured. For details, refer to Sections 3.2 "Setting Wiring System" (page 3-2) and 4.2 "Setting Measuring Ranges" (page 4-4).

### Setting Measuring Ranges

3. Press the voltage range or current range setting key to set the desired measuring range. For details, refer to 4.2 "Setting Measuring Ranges" (page 4-5).

### Setting Voltage/Current Measurement Mode (RMS, MEAN or DC)

Measured peak voltage or current is independent of the measurement mode.

### Setting Peak Hold Mode

#### Setting the Peak Hold Function

1. Press the **MISC (SHIFT + □)** key.  
Press the  $\wedge$  or  $\vee$  key until "HOLD-F" is displayed on display D.
2. Press the **ENTER** key.
3. "HOLD-F" will move to display C, and "PEEH" on display D begins to blink.  
Press the  $\wedge$  or  $\vee$  key to set the desired peak hold function.
  - PEEH** : Holds Vpk (peak voltage) and Apk (peak current) in absolute values.
  - ALL** : Holds V (voltage), A (current), W (active power), VA (apparent power), var (reactive power), Vpk (peak voltage) and Apk (peak current) in absolute values.
4. Press the **ENTER** key.

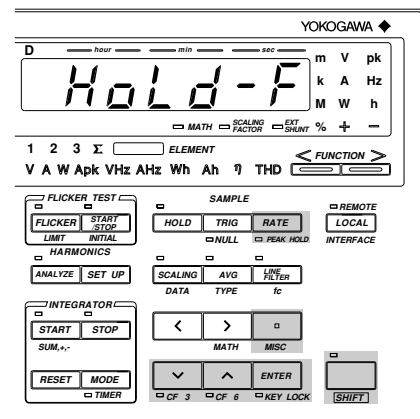

#### Turning Peak Hold Mode ON/OFF

Press the **PEAK HOLD (SHIFT + RATE)** key. The PEAK HOLD LED will light up when the peak hold mode is active. To cancel the peak hold mode, press the **PEAK HOLD (SHIFT + RATE)** key again.

#### Note

- Peak hold mode will be canceled if the range, measurement mode, line filter or averaging setting is changed.

## 5.3 Displaying Computed Apparent Power

### Basic Computing Equation

For details, refer to Section 16 "Specifications."

### Computing Accuracy

For details, refer to Section 16 "Specifications."

### Computing Range for Apparent Power

For details, refer to Section 16 "Specifications."

### Rated Value for Apparent Power

Voltage and current ranges are combined to measure apparent power.

For details, refer to Section 4.2 "Setting Measuring Ranges" (page 4-6).

## Function Setting

### Operating the *FUNCTION* Key

Computed apparent power is displayed on display C. Press the *FUNCTION* key below display C to select VA (apparent power) .

For details, refer to Section 4.3 "Selecting What to Display on Digital Displays" (page 4-10).

## Setting Element to be Measured

### Operating the *ELEMENT* Key

Press the *ELEMENT* key below display C to select the element to be measured.

### Setting *WIRING* System

For details, refer to Section 3.2 "Setting Wiring System" (page 3-2).

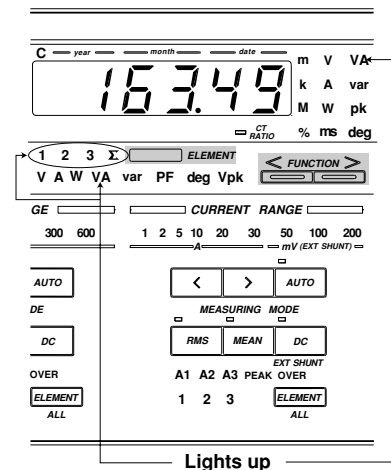

### Note

- Even if the measurement mode for voltage is different from that for current, computation is still carried out with the modes unchanged.  
For instance, if the voltage measurement mode is  $V_{rms}$  and the current measurement mode is  $A_{mean}$ , the computed apparent power will be the result of  $V_{rms} \times A_{mean}$ .

## 5.4 Displaying Computed Reactive Power

### Basic Computing Equation

For details, refer to Section 16, "Specifications."

### Computing Accuracy

For details, refer to Section 16, "Specifications."

### Computing Range for Reactive Power

For details, refer to Section 16, "Specifications."

### Rated Value for Reactive Power

Voltage and current ranges are combined to measure reactive power.

For details, refer to Section 4.2 "Setting Measuring Ranges" (page 4-6).

## Function Setting

### Operating the **FUNCTION** Key

Press the **FUNCTION** key below display C to select **var** (reactive power).

For details, refer to Section 4.3 "Selecting What to Display on Digital Displays" (page 4-10).

## Setting Element to be Measured

### Operating the **ELEMENT** Key

Press the **ELEMENT** key below display C to select the element to be measured.

### Setting **WIRING** System

For details, refer to Section 3.2 "Setting Wiring System" (page 3-2).

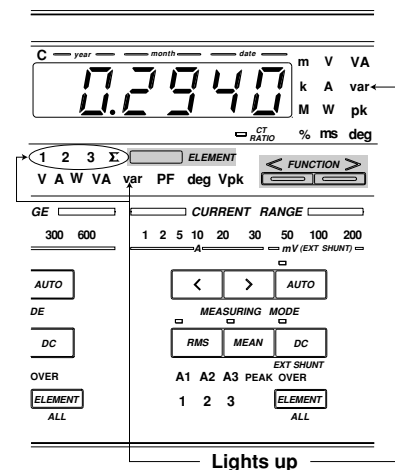

### Note

- Even if the measurement mode for voltage is different from that for current, computation is still carried out with the modes unchanged.  
For instance, if the voltage measurement mode is  $V_{rms}$  and the current measurement mode is  $A_{mean}$ , the apparent power will be obtained using the equation " $var = \sqrt{(V_{rms} \times A_{mean})^2 - W^2}$ ."

# 5.5 Displaying Computed Power Factor

## Basic Computing Equation

For details, refer to Section 16, "Specifications."

## Computing Accuracy

For details, refer to Section 16, "Specifications."

## Display Range

Display range: -1.0000 to 1.0000

If the computation result exceeds "1" due to inputs being outside the effective operating input range, the following will be displayed.

| Computation Result | Display |
|--------------------|---------|
| 1.0001 to 2.0000   | 1.0000  |
| 2.0001 or higher   | PFERR   |

If either input voltage or input current is below 0.5% of the rated value of the range used, "PFERR" will be displayed.

## Function Setting

### Operating the FUNCTION Key

Press the **FUNCTION** key below display C to select **PF** (power factor).

For details, refer to Section 4.3 "Selecting What to Display on Digital Displays" (page 4-10).

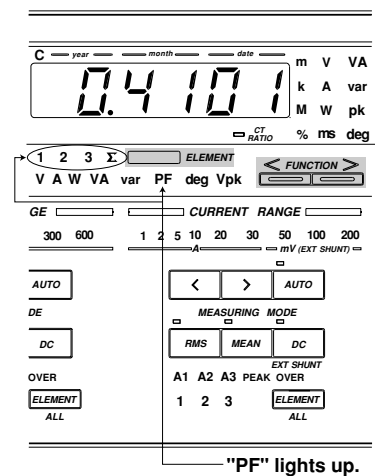

## Setting Element to be Measured

### Operating the ELEMENT Key

Press the **ELEMENT** key below display C to select the element to be measured.

### Setting WIRING System

For details, refer to Section 3.2 "Setting Wiring System" (page 3-2).

## Note

- Even if the measurement mode for voltage is different from that for current, computation is still carried out with the modes unchanged.

For instance, the voltage measurement mode is  $V_{rms}$  and the current measurement mode is  $A_{mean}$ , the power factor will be obtained using the equation  $PF = \frac{W}{V_{rms} \times A_{mean}}$ .

## 5.6 Displaying Computed Phase Angle

### Basic Computing Equation

For details, refer to Section 16, "Specifications."

### Computing Accuracy

For details, refer to Section 16, "Specifications."

### Computing Range for Phase Angle

For details, refer to Section 16, "Specifications."

### Display Resolution

For details, refer to Section 16, "Specifications."

Distinction between phase lag and lead is indicated as below.



If the power factor exceeds "1", the following will be displayed.

| Power Factor       | Display     |
|--------------------|-------------|
| 1. 0.001 to 2.0000 | 0.00 deg    |
| 2. 0.001 or higher | d E E E r r |

### Note

- Before computing the phase angle (deg), make sure that both the voltage and current are within the effective measurement range.
- Distinction between phase lag and lead is made properly only when both voltage and current are sine waves.
- If either the measured voltage or current is below 0.5% of the rated value of the range used, "d E E E r r" will be displayed.
- Even if the measurement mode for voltage is different from that for current, computation is still carried out with the modes unchanged.

For instance, if the voltage measurement mode is Vrms and the current measurement mode is Amean, the phase angle (deg) will be obtained using the equation

$$\text{deg} = \cos^{-1}\left(\frac{W}{V_{\text{rms}} \times A_{\text{mean}}}\right)$$

## Function Setting

### Operating the **FUNCTION** Key

Press the **FUNCTION** key below display C to select **deg** (phase angle). For details, refer to Section 4.3 "Selecting What to Display on Digital Displays" (page 4-10).

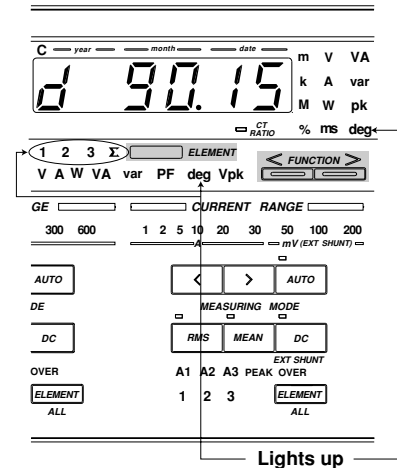

## Setting Element to be Measured

### Operating the **ELEMENT** Key

Press the **ELEMENT** key below display C to select the element to be measured.

### Setting **WIRING** System

For details, refer to Section 3.2 "Setting Wiring System" (page 3-3).

## Setting Phase Angle Display Method

1. Press the **MISC** key (**SHIFT** + **□**).  
Press the **∧** or **∨** key until "d E C" appears on display D.

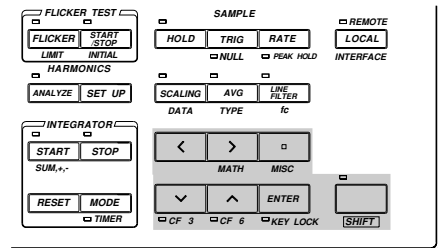

2. Press the **ENTER** key.  
"d E C" will disappear from display D, and instead will appear on display A. The phase angle currently set will appear on display B.

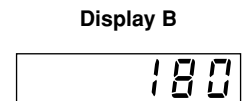

Default setting: 180°

3. Press the **∧** or **∨** key to set the phase angle display method (180° or 360°).
4. Press the **ENTER** key.

### Note

The phase angle is displayed as follows when the 360° display method is selected.

Calculation is performed using  $\cos^{-1}\left(\frac{W}{VA}\right)$ , which gives a phase angle between 0° and 180°.

Distinction of phase lag/lead is then made, and computed results are displayed.

In the case of phase lag : phase angle calculated using  $\cos^{-1}\left(\frac{W}{VA}\right)$  is displayed.

In the case of phase lead : phase angle calculated using  $360^\circ - \cos^{-1}\left(\frac{W}{VA}\right)$  is displayed.

No phase lag or lead code (C or d) is indicated.

# 6.1 Measuring Frequency

## Display Range

For display range, refer to Section 16."Specifications."

- If the input signal level is low or the input frequency is below the measurement range, the error code "ERR-L" will be displayed. The same error code will also be displayed if no input signal is input to the element.
- If the input frequency is above the measurement range, error code "ERR-H," will be displayed.

## Function Setting

1. Press the **FUNCTION** key below display D to select **VHz** (voltage frequency) or **AHz** (current frequency).  
For details, refer to Section 4.3 "Selecting What to Display on Digital Displays" (page 4-10).

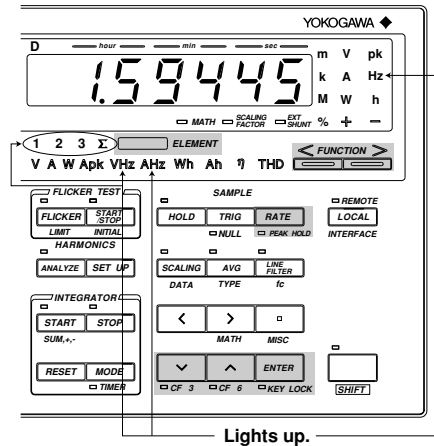

## Setting the Sample Rate

2. Press the **RATE** key to set the desired sample rate. The measurable frequency range varies according to the sample rate. For a detailed description of how to set the sample rate, refer to Section 4.1, "Setting Measuring Conditions" (page 4-2).

| Sample Rate   | Lower Limit Frequency | Frequency Range   | Minimum Display | Measurement Time |
|---------------|-----------------------|-------------------|-----------------|------------------|
| 0.250 (250ms) | 20Hz                  | 20Hz ≤ f ≤ 1MHz   | 18.00Hz         | 60ms             |
| 0.500 (500ms) | 10Hz                  | 10Hz ≤ f ≤ 500kHz | 9.000Hz         | 120ms            |
| 2.000 (2s)    | 2Hz                   | 2Hz ≤ f ≤ 100kHz  | 1.8000Hz        | 600ms            |

## Measuring Frequency with Filter ON

The frequency filter can be used to eliminate noise or harmonics, such as those that appear in inverter waveforms, when measuring the fundamental frequency. To eliminate noise during measurement of frequencies below 100 Hz, it is also recommended that you turn ON the filter.

1. Press the **MISC (SHIFT + □)** key.  
Press the **∧** or **∨** key until "F-F, L L" is displayed on display D.
2. Press the **ENTER** key.  
"F-F, L L" will move to display C, and "□ F F" on display D begins to blink.
3. Press the **∧** or **∨** key to display "□ n", then press the **ENTER** key.
4. To turn the frequency filter OFF, press the **∧** or **∨** key to display "□ F F" on display D, then press the **ENTER** key.

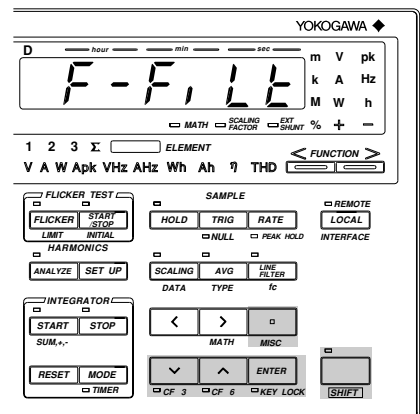

### Note

- If the filter is ON and a signal with a frequency of 440 Hz or higher is input, an error code "ERR-L" may be displayed depending on the frequency and level of the signal. This is because the signal is attenuated by the filter and therefore its presence is not recognized. In this case, turn the filter OFF.

# 7.1 Measuring Efficiency

## Display Resolution

The display resolution for efficiency measurement is 0.01.

## Displaying the Computed Value

The computed result is displayed on display D as a percentage (%).

## Function Setting

### Operating the **FUNCTION** Key

1. Press the **FUNCTION** key below display D to select  $\eta$ . For details, refer to Section 4.3 "Selecting What to Display on Digital Displays" (page 4-10).
2. Press the **MATH** key (**SHIFT** + **>**). " $\bar{n} R \xi H$ " will be displayed on display C.
3. Press the  $\wedge$  or  $\vee$  key until "EFF," is displayed on display D. The symbol displayed on display D changes in the following order.

EFF,  $\rightarrow$  [F  $\bar{H}$  1]  $\rightarrow$  ([F  $\bar{H}$  2])  $\rightarrow$  [F  $\bar{H}$  3]  $\rightarrow$  [F R 1]  $\rightarrow$  ([F R 2])  $\rightarrow$  [F R 3]  $\rightarrow$  R  $\bar{t}$  b  $\rightarrow$  R - b  $\rightarrow$  R , b  $\rightarrow$  R  $\bar{c}$  b  $\rightarrow$  R  $\bar{c}$  b  $\bar{c}$  2  $\rightarrow$  R  $\bar{c}$  2  $\bar{c}$  b  $\rightarrow$  EFF,  $\rightarrow$  ...

Symbols within brackets are displayed only on the three-phase, four-wire model (253103).

4. Press the **ENTER** key.

## Setting Wiring System

5. Set the wiring system by pressing the **WIRING** key. Computing equations for efficiency are given on the next page. Make sure that the correct wiring system is selected, otherwise incorrect computed values will be obtained.

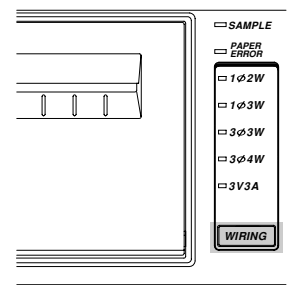
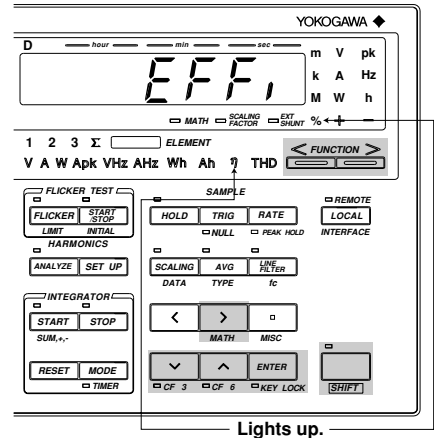



**Wiring Systems and Basic Computing Equations**

- **When both the input and output wiring systems are two-wire system**

Select 1Φ2W, 1Φ3W or 3Φ3W for three-phase, three-wire model (253102) and select 1Φ2W for three-phase, four-wire model (253103).

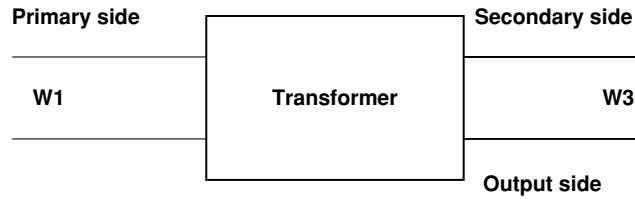

**Computing equation**

$$\text{Efficiency } (\eta) = \frac{W3}{W1} \times 100$$

- **When the input is two-wire and the output is a three-wire system**

Select 1Φ3W, 3Φ3W, 3Φ4W or 3V3A. This is only applicable for the 253103.

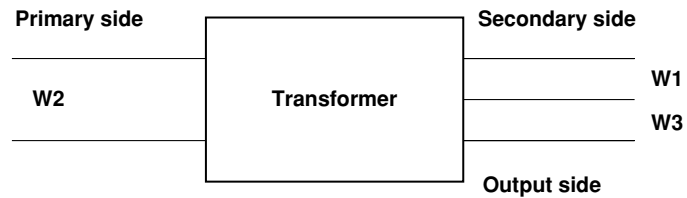

**Computing equation**

$$\text{Efficiency } (\eta) = \frac{W1+W3}{W2} \times 100$$

**Note**

- For the basic computing equations and the wiring method, refer to Section 3.5 "Wiring System and Equations of Efficiency" (page 3-15).
-

## 7.2 Measuring the Crest Factor

The MATH function is used to calculate the crest factor and display it on display D.

### Function Setting

#### Operating the **FUNCTION** Key

1. Press the **FUNCTION** key below display D to select  $\eta$ . For details, refer to Section 4.3 "Selecting What to Display on Digital Displays" (page 4-10).

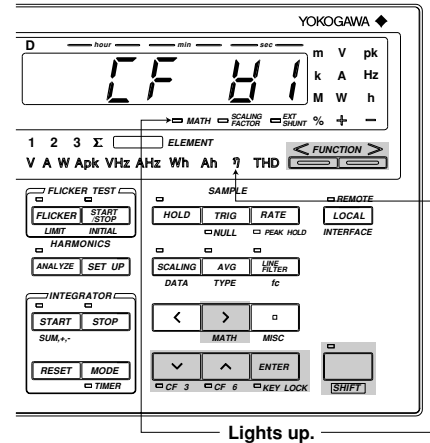

### Setting the Computing Equation

2. Press the **MATH** key (**SHIFT** + **>**).  
"  $\bar{n}$   $\bar{A}$   $\bar{L}$   $\bar{H}$  " will be displayed on display C.
3. Press the  $\wedge$  or  $\vee$  key. The computing equation displayed on display D changes in the following order. Select one of the computing equations from  $[F \ H \ 1]$  to  $[F \ H \ 3]$  or  $[F \ A \ 1]$  to  $[F \ A \ 3]$ .

$EFF, \rightarrow [F \ H \ 1] \rightarrow ([F \ H \ 2]) \rightarrow [F \ H \ 3] \rightarrow [F \ A \ 1] \rightarrow ([F \ A \ 2]) \rightarrow [F \ A \ 3] \rightarrow A \bar{L} \bar{b} \rightarrow A - \bar{b} \rightarrow A, \bar{b} \rightarrow A \bar{L} \bar{b} \rightarrow A \bar{L} \bar{b}^2 \rightarrow A^2 \bar{L} \bar{b} \rightarrow EFF, \rightarrow \dots$

Symbols within brackets are displayed only on the three-phase, four-wire model (253103).

4. Press the **ENTER** key.

#### Crest Factor Computing Equations and Display

- $[F \ H \ 1]$  : (Peak value of V1) / (rms value of V1)
- $[F \ H \ 2]$  : (Peak value of V2) / (rms value of V2) (Available only for 253103)
- $[F \ H \ 3]$  : (Peak value of V3) / (rms value of V3)
- $[F \ A \ 1]$  : (Peak value of A1) / (rms value of A1)
- $[F \ A \ 2]$  : (Peak value of A2) / (rms value of A2) (Available only for 253103)
- $[F \ A \ 3]$  : (Peak value of A3) / (rms value of A3)

#### Note

- Crest factor is defined as peak value / rms value.
- " - - - - - " will be displayed if the measuring mode is MEAN or DC.

## 7.3 Four Arithmetical Operations Using Display D

The MATH function enables the four arithmetical operations on the measured values displayed on displays A and B, and displays the result on display D.

### Function Setting

#### Operating the **FUNCTION** Key

1. Press the **FUNCTION** key below display D to select  $\eta$ . For details, refer to Section 4.3 "Selecting What to Display on Digital Displays" (page 4-10).

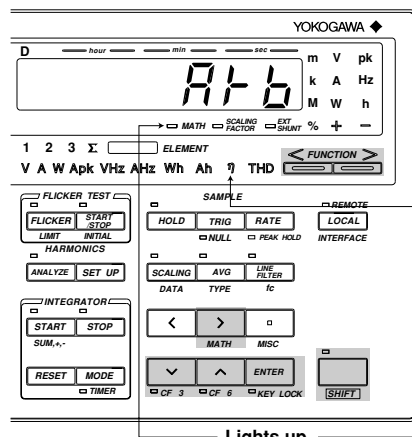

### Setting the Computing Equation

2. Press the **MATH** key (**SHIFT** + **>**).  
"  $\bar{A} \bar{A} \bar{E} H$  " will be displayed on display C.
3. Press the  $\wedge$  or  $\vee$  key. The computing code on display D changes in the following order. Select one of the computing equations from "  $A \bar{+} b$  ", "  $A - b$  ", "  $A \cdot b$  ", "  $A \div b$  ", "  $A \div b^n$  " and "  $A^n \div b$  ".

$EFF, \rightarrow [F \bar{H} 1] \rightarrow ([F \bar{H} 2]) \rightarrow [F \bar{H} 3] \rightarrow [F \bar{A} 1] \rightarrow ([F \bar{A} 2]) \rightarrow [F \bar{A} 3] \rightarrow A \bar{+} b \rightarrow A - b \rightarrow A \cdot b \rightarrow A \div b \rightarrow A \div b^n \rightarrow A^n \div b \rightarrow EFF, \rightarrow \dots$

Symbols within brackets are displayed only on the three-phase, four-wire model (253103).

4. Press the **ENTER** key.

#### Note

- The computing codes displayed on display D are described as follows.
  - $\bar{+}$  : + (addition)
  - $-$  : - (subtraction)
  - $\cdot$  : x (multiplication)
  - $\div$  : / (division)
  - $\wedge$  : ^ (repeated multiplication)
- If INTEG TIME (elapsed time of integration) is selected on display A, " - - - - - " (no data) will be displayed as the computation result.
- If the value displayed on display B is 0.0001% of the rated value or below, " - -  $\square$  F - - " will be displayed as the computation result.

**Application Examples**

**Addition of two measured values (power)**

$A + B$  : Result of display A + display B is displayed.

Example:

| Display A | Display B | Display D             | Wiring System |
|-----------|-----------|-----------------------|---------------|
| W1        | W2 or W3  | W1 + W2<br>or W1 + W3 | Any           |

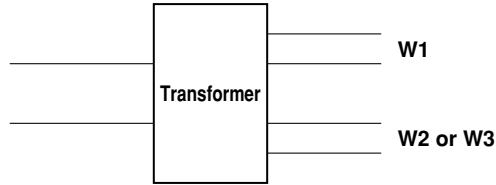

**Computation of power loss**

$A - B$  : Result of display A – display B is displayed.

Example 1:

| Display A | Display B | Display D | Wiring System |
|-----------|-----------|-----------|---------------|
| W1        | W3        | W1 – W3   | Any           |

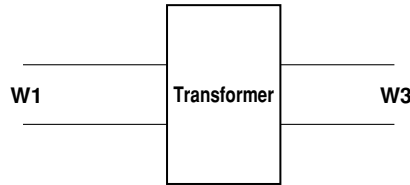

Example 2:

| Display A                | Display B | Display D       | Wiring System |
|--------------------------|-----------|-----------------|---------------|
| $\Sigma W (= W_1 + W_3)$ | W2        | $\Sigma W - W2$ | 3Φ3W          |

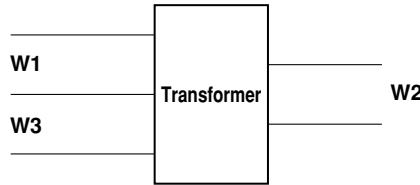

Example 3:

| Display A | Display B                | Display D       | Wiring System |
|-----------|--------------------------|-----------------|---------------|
| W2        | $\Sigma W (= W_1 + W_3)$ | W2 – $\Sigma W$ | 3Φ3W          |

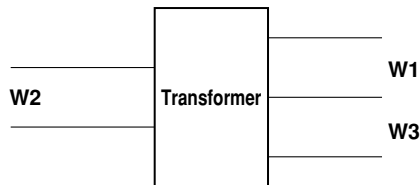

$A \times B$  : Result of display A x display B is displayed.

This can be used when a function other than VA (apparent power) is set for display C to display computed apparent power (VA) on display D.

Example:

| Display A        | Display B        | Display D                           | Wiring System |
|------------------|------------------|-------------------------------------|---------------|
| V <sub>rms</sub> | A <sub>rms</sub> | V <sub>rms</sub> x A <sub>rms</sub> | Any           |

### 7.3 Four Arithmetical Operations Using Display D

$\frac{A}{B}$  : Result of display A / display B is displayed.

This can be used to calculate impedance absolute value.

Example 1:

| Display A | Display B | Display D                   | Wiring System |
|-----------|-----------|-----------------------------|---------------|
| V1rms     | A1rms     | $ Z  = \frac{V1rms}{A1rms}$ | Any           |

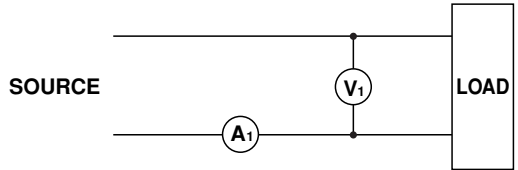

This can be also used to calculate the line voltage ratio or the phase current ratio of a three-phase wiring system.

Example 2:

| Display A | Display B | Display D             | Wiring System |
|-----------|-----------|-----------------------|---------------|
| V1rms     | V3rms     | $\frac{V1rms}{V3rms}$ | 3Φ3W          |
| A1rms     | A3rms     | $\frac{A1rms}{A3rms}$ |               |

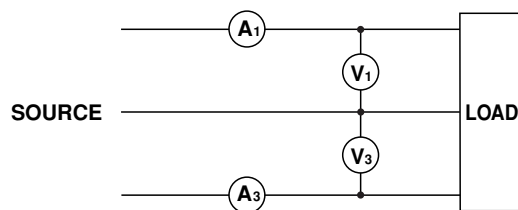

$\frac{A}{B^2}$  : Result of display A / (display B)<sup>2</sup> is displayed.

This can be used to calculate impedance.

Example:

| Display A | Display B | Display D                  | Wiring System |
|-----------|-----------|----------------------------|---------------|
| W1        | A1rms     | $R = \frac{W1}{(A1rms)^2}$ | Any           |

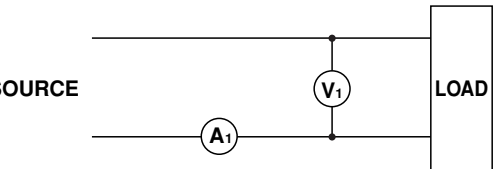

$\frac{A^2}{B}$  : Result of (display A)<sup>2</sup> / display B is displayed.

This can be used to calculate impedance.

Example:

| Display A | Display B | Display D                  | Wiring System |
|-----------|-----------|----------------------------|---------------|
| V1rms     | W1        | $R = \frac{(V1rms)^2}{W1}$ | Any           |

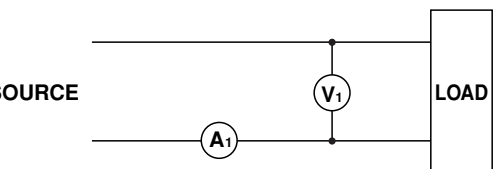

# 7.4 Using the Scaling Function

## Overview of the Scaling Function

The scaling function multiplies measured values such as voltage, current and power by the scaling value and then displays the results. When measuring inputs that exceed the measuring range, an external potential transformer (PT) or current transformer (CT) is used. In this case, setting the scaling value to the PT ratio or CT ratio converts measured values to the corresponding values for the transformer primary side before they are displayed.

| Display Item   | Measured/Computed | Value Scaled Value                            |
|----------------|-------------------|---|
| Voltage        | V                 | $K_v \times V$                                |
| Current        | A                 | $K_i \times A$                                |
| Active power   | W                 | $K_v \times K_i \times K_w \times W$          |
| Reactive power | var               | $K_v \times K_i \times K_w \times \text{var}$ |
| Apparent power | VA                | $K_v \times K_i \times K_w \times VA$         |

$K_v$  : Voltage scaling value (PT ratio)  
 $K_i$  : Current scaling value (CT ratio)  
 $K_w$  : Scaling factor

## Setting Scaling Values

### Setting the PT/CT Ratio and Scaling Factor

1. Press the **DATA** key (**SHIFT + SCALING**). The currently set element, PT ratio, CT ratio and scaling factor will be displayed on displays B, C and D respectively, and each indicator LED will light up. Press the  $\wedge$  or  $\vee$  key until the desired element is displayed on display A. The display changes in the order of  $\text{H L L}$  (all elements)  $\rightarrow$   $\text{E L 1}$  (element 1)  $\rightarrow$   $\text{E L 2}$  (element 2, applicable only for the 253103)  $\rightarrow$   $\text{E L 3}$  (element 3)  $\rightarrow$   $\text{E n d}$  (to end making setting) and back to . The digit on the extreme left of the PT ratio (display B) will start blinking.

Follow steps 2 to 5 to set the PT ratio, CT ratio and scaling factor.

2. Shifting the blinking position  
 The blinking position can be shifted to the left or right by pressing the  $\wedge$  or  $\vee$  key respectively.

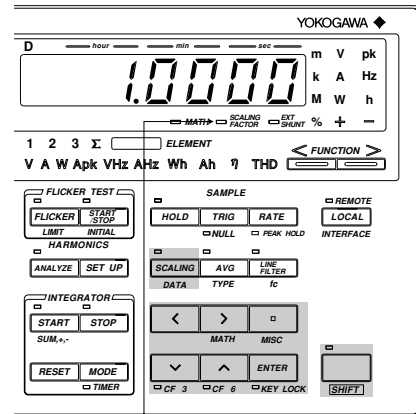
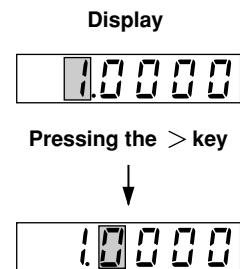

Lights up.

3. Setting a value

To set the value of the blinking digit, press the  $\wedge$  or  $\vee$  key.

Pressing the  $\wedge$  key changes the value in the order 1, 2, 3 ... 9, 0 and back to 1.

Pressing the  $\vee$  key changes the value in the opposite direction.

Default value (PT and CT) : 1.0000

Minimum value : 0.0001

Maximum value : 10000

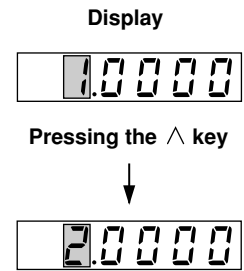

4. Shifting the decimal point position

The decimal point can be shifted by pressing the  $\square$  key.

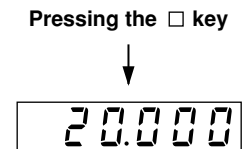

5. After setting of the PT ratio has been completed, press the **ENTER** key. The leftmost digit of the CT ratio now starts blinking.

6. When the **ENTER** key is pressed in step 5, the next element is now displayed on display A. Repeat steps 2 to 5.

7. To exit from setting mode, select “ $E r d$ ” on display C and then press the **ENTER** key. To exit from setting mode in the middle of making settings, press the **SHIFT** key or **SCALING (DATA)** key.

**Turning the Scaling Function ON**

Press the **SCALING** key. The SCALING indicator LED will light up. To turn OFF scaling, press the **SCALING** key again. This causes the SCALING indicator LED to go out.

|             | Voltage           | Current           |
|-------------|-------------------|-------------------|
| Scaling OFF | PT secondary side | CT secondary side |
| Scaling ON  | PT primary side   | CT primary side   |

**Note**

- If an attempt is made to set a scaling value that is outside the setting range, error code “ $E r r 12$ ” is displayed. In this case, enter a valid value.
- When an external shunt is used, refer to Section 4.2 “Setting Measuring Ranges” (page 4-7).

**Precautions When Setting Measuring Ranges with Scaling Function ON**

If the scaled measured value exceeds 50000M (or 500000M in the case of integration), the following code will be displayed.

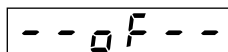

## 7.5 Using Averaging Functions

If reading measured values (power) is difficult due to fluctuations in the power source or load, or due to the low frequency of the measured signal, averaging functions can be used to stabilize the displayed values to make reading easier. Two types of averaging function are available with this instrument; exponential averaging and moving averaging.

### Exponential Averaging

Exponential averaging is expressed by the following equation.

$$D_n = D_{n-1} + (M_n - D_{n-1})/K$$

$D_n$  (the value at the "n"th display) is obtained by subtracting  $D_{n-1}$  (obtained by applying exponential averaging to the values up to the "n - 1"th) from the measured value  $M_n$ , dividing the result by  $K$  (the attenuation constant), then adding the quotient to  $D_{n-1}$ .

### Moving Averaging

Moving averaging is expressed by the following equation.

$$D_n = (M_{n-(m-1)} + \dots + M_{n-2} + M_{n-1} + M_n)/m$$

$D_n$  is obtained by simply dividing the sum of the measured values including  $M_n$  by  $m$  (the number of data).

### Setting Averaging Type (effective only for normal measurement)

1. Press the **TYPE** key (**SHIFT + AVG.**)  
 "AHC" will be displayed on display B, indicating that averaging type selection mode is now active.
2. The currently selected averaging type will be displayed on display C.  
 Press the  $\wedge$  or  $\vee$  key until the desired averaging type ("EP" or "L n") is displayed on display C.  
 EP : Exponential averaging  
 L n : Moving averaging

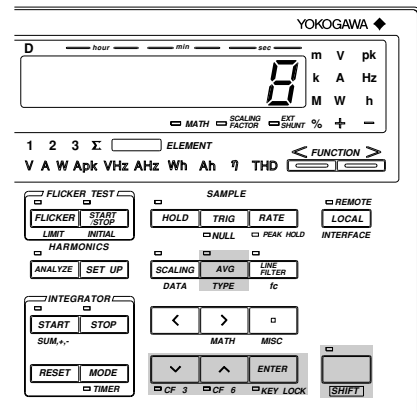

3. Press the **ENTER** key.

### Setting the Attenuation Constant or Averaging Sample Number (effective only for normal measurement)

4. Press the  $\wedge$  or  $\vee$  key to set an attenuation constant ( $K$ ) or sample number ( $m$ ).  
 Exponential averaging : selectable attenuation constant ( $K$ ) : 8, 16, 32, 64, 128, 256  
 Moving averaging : selectable sample number ( $m$ ) : 8, 16, 32, 64, 128, 256
5. Press the **ENTER** key.



### Averaging during Harmonic Analysis

This provides a 1st-order low-pass filter with time constant of 1.5 s if the fundamental frequency is 50/60 Hz with exponential averaging. In case the analysis window width is 16, the attenuation constant (K) will be 5.625 if the PLL synchronous source's frequency is 55 Hz or higher and below 75 Hz. If other frequency is selected, it will be 4.6875.

### Starting Averaging Process

6. Press the **AVG** key.

The AVG indicator LED lights up, indicating that the averaging function is ON. To turn OFF the averaging function, press the **AVG** key again. This causes the AVG indicator LED to go out.

## 7.6 Using the NULL Function

### Overview of the NULL Function

If DC has been selected as the voltage or current measurement mode, the measured value obtained just after the **NULL** key is pressed will be used as the NULL value. The NULL function is valid until the **NULL** key is pressed again.

### Display Content

The following data is displayed when the NULL function is ON.

| Voltage Measurement Mode | Current Measurement Mode | Display Content  |
|--------------------------|--------------------------|--|
| DC                       | DC                       | $V = V_{DC} - V_{NULL}$ $A = A_{DC} - A_{NULL}$ $W = (V_{dc} - V_{NULL}) \times (A_{dc} - A_{NULL})$ $= V_{dc} \times A_{dc} - V_{dc} \times A_{NULL} - A_{dc} \times V_{NULL} + V_{NULL} \times A_{NULL}$ $= W' - V_{DC} \times A_{NULL} - A_{DC} \times V_{NULL} + V_{NULL} \times A_{NULL}$ |
| DC                       | RMS, MEAN                | $V = V_{DC} - V_{NULL}$ $A = A_{AC}$ $W = (V_{dc} - V_{NULL}) \times A_{ac}$ $= V_{dc} \times A_{ac} - A_{ac} \times V_{NULL}$ $= W' - A_{ac} \times V_{NULL}$   |
| RMS, MEAN                | DC                       | $V = V_{AC}$ $A = A_{DC} - A_{NULL}$ $W = V_{ac} \times (A_{dc} - A_{NULL})$ $= V_{ac} \times A_{dc} - V_{ac} \times A_{NULL}$ $= W' - V_{AC} \times A_{NULL}$   |
| RMS, MEAN                | RMS, MEAN                |  |

$V_{dc}$  : Instantaneous voltage value (DC mode)

$A_{dc}$  : Instantaneous current value (DC mode)

$V_{DC}$  : Voltage value after averaging (DC mode)

$A_{DC}$  : Current value after averaging (DC mode)

$W'$  : Power after averaging

$V_{ac}$  : Instantaneous voltage value (RMS, MEAN mode)

$A_{ac}$  : Instantaneous current value (RMS, MEAN mode)

$V_{AC}$  : Voltage value after averaging (RMS, MEAN mode)

$A_{AC}$  : Current value after averaging (RMS, MEAN mode)

### Measuring with NULL Function ON

Press the **NULL (SHIFT + TRIG)** key.

The NULL value will be set and the NULL LED lights up.

To cancel the NULL function, press the **NULL (SHIFT + TRIG)** key again. The NULL LED will go out, indicating that the NULL function is OFF.

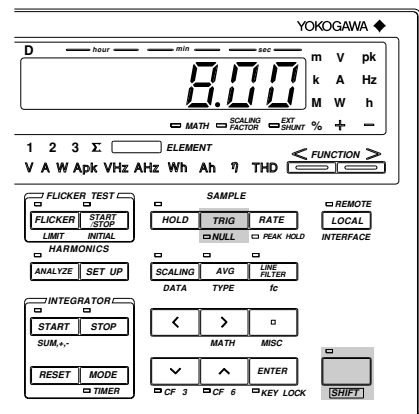

### Note

- The NULL function will be canceled if the measurement mode, range, display update interval, line filter, averaging or crest factor is changed.
- The NULL function will not operate during integration, harmonic analysis or flicker measurement.
- If an attempt is made to turn the NULL function ON while auto range is ON, "ERR 15" will occur.
- If an attempt is made to turn the NULL function ON when "DC" is not selected for both voltage and current modes, "ERR 15" will occur.

# 8.1 Overview of Integrator Functions

## Integration Modes

Wh (integration of active power) or Ah (integration of current) can be set for display D, to allow display of the following data on each display and setting of the following 4 integration modes. The instrument does not measure or display voltage and current values.

| Display A  | Display B    | Display C    | Display D                                       |
|--|--------------|--------------|---|
| Elapsed time of integration                      | Active power | Active power | Integrated value Frequency (Refer to Chapter 6) |
| (Displayed only when "W" is set as the function) |              |              |   |

| Integration Mode          | Start                                      | Stop               | Repeat | Integration Time              |
|---------------------------|--|--------------------|--------|-------------------------------|
| 1. Manual integration     | <b>START</b> key or through communications | <b>STOP</b> key    | No     | From start to stop            |
| 2. Standard integration   | <b>START</b> key                           | Integration timer  | No     | Time set on integration timer |
| 3. Continuous integration | <b>START</b> key                           | <b>STOP</b> key    | Yes    | Time set on integration timer |
| 4. Real time counting     |  |                    |        |                               |
| Standard integration      | Reserved start time                        | Reserved stop time | No     | Reserved time duration        |
| Continuous integration    | Reserved start time                        | Reserved stop time | Yes    | Time set on integration timer |

### Manual Integration Mode

In this mode, integration starts when the **START** key is pressed, and stops when the integration time reaches the maximum (999 hours and 59 minutes) or the integrated power (Wh) or current (Ah) reaches the maximum (999999 MWh/MAh). The instrument holds the integration time and power (or current) of the stop point.

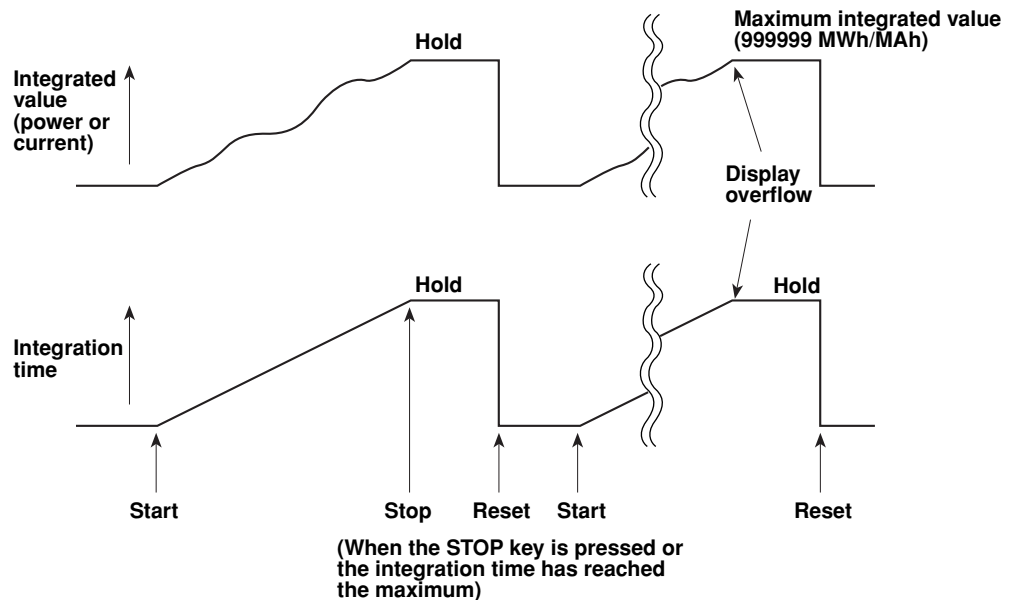

**Standard Integration Mode (Timer Mode)**

In this mode, integration starts when the **START** key is pressed, and stops when the timer preset time is reached or the integrated value reaches the maximum, whichever is first. The instrument holds the integration value and integration time of the stop point.

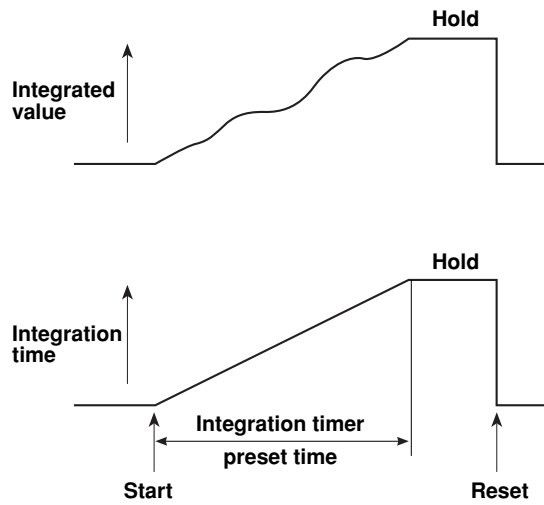

**Continuous Integration Mode (Repeat Integration)**

In this mode, integration starts when the **START** key is pressed. When the timer preset time is reached, the integrated value and integration time are reset automatically and restarted immediately. This is repeated continuously until the **STOP** key is pressed. If the integrated value reaches the maximum before the timer preset time is reached, integration stops and the instrument holds the integration value and integration time.

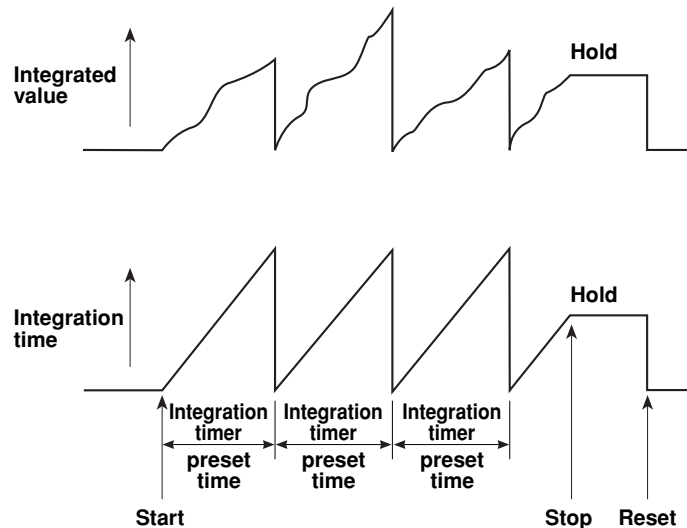

**Real Time Counting Standard Integration Mode**

In this mode, integration start/stop time can be set to an actual time. Integration starts at the preset start time, and it stops when the preset stop time is reached or the integrated value reaches the maximum. The instrument holds the integrated value and integration time of the stop point. If preset time has been set on the integration timer and this preset time is reached before the preset stop time is reached, the instrument will hold the integrated value and integration time.

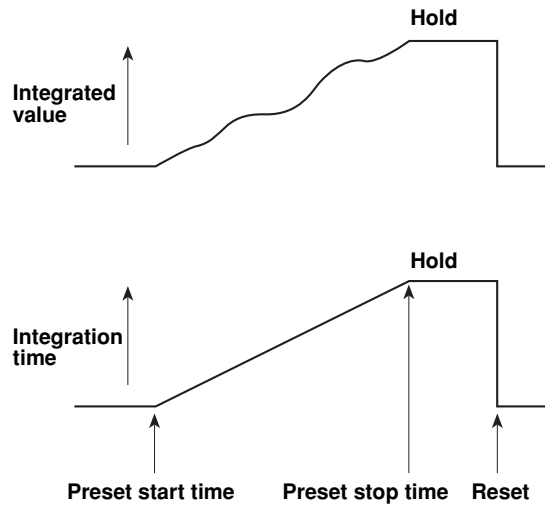
**Real Time Counting Continuous Integration Mode (Repeat Integration)**

In this mode, integration start/stop time can be set to an actual time. Integration starts at the preset start time, and is repeated at intervals (timer preset time) until the preset stop time is reached. When the timer preset time is reached, the integrated value and integration time are reset automatically and restarted immediately. When the preset stop time is reached or the integrated value reaches the maximum, integration stops and the instrument holds the integrated value and integration time.

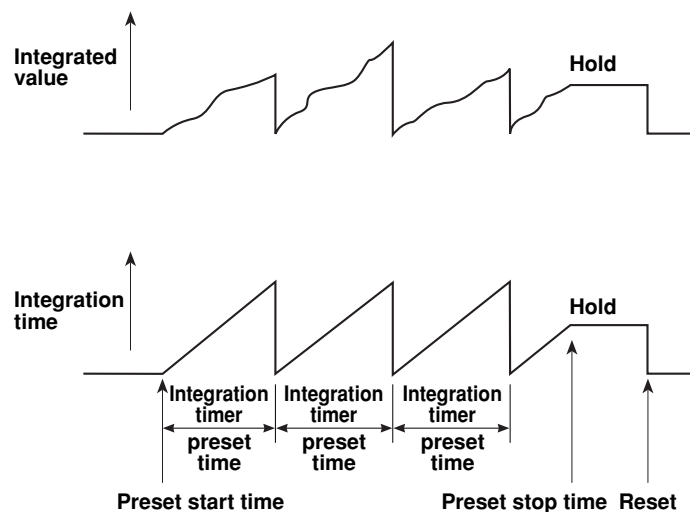

**There are two ways to start, stop and reset integration.**

For details, refer to the pages given below.

- Using the **START**, **STOP** and **RESET** keys (Integrator):  
refer to Section 8.3 "Displaying Integrated Value" (page 8-10).
- Using GP-IB/RS-232-C commands:  
refer to Sections 14.2 "Using the GP-IB Interface" (page 14-4) and 14.3 "Using the RS-232-C Interface" (page 14-7).
- Using an external signal:  
refer to Sections 12.2 "Remote Control" (page 12-2).

**Display Update Rate (Sample Rate)**

Once integration is started, the display update rate will be set to 2 seconds automatically. If the **RATE** key is pressed in an attempt to change the display update rate during integration, an error code "Err 13" will be displayed.

**Sampling Frequency and Measuring Frequency Range**

A sampling frequency of approximately 110 kHz is used for integration. All sample data is integrated at this frequency.

|   |          | <b>Measuring Frequency Range</b> |  |
|---|----------|----------------------------------|--|
| Power integration                         |          | DC to 50 kHz                     |  |
| Current integration<br>(Measurement mode) | RMS/MEAN | DC, 20 Hz to 50 kHz              |  |
|   | DC       | DC to 50 kHz                     |  |

Computing equations are given below.

|                     |      |  |
|---------------------|------|--|
| Power integration   |      | $\sum_{N=0}^n (\sum v_i \cdot i_i) = \sum_{N=0}^n v_i \cdot i_i$ |
| Current integration | RMS  | $\sum_{N=0}^n (\sqrt{\sum i_i^2})$                               |
|                     | MEAN | $\sum_{N=0}^n (\sum  i_i ) = \sum_{N=0}^n  i_i $                 |
|                     | DC   | $\sum_{N=0}^n (\sum i_i) = \sum_{N=0}^n i_i$                     |

( ) : Integrated value at each display update interval  
 N: No. of updates  
 Vi , ii : Sample data

A description is given for polarity integration. Ah+ and Ah- are used when the measurement mode is DC.

- Wh+ : Performs integration on instantaneous power with both Vi and Ii being positive.
- Wh- : Performs integration on instantaneous power with both Vi and Ii being negative.
- Ah+ : Performs integration on instantaneous current with Ii being positive.
- Ah- : Performs integration on instantaneous current with Ii being negative.

**Note**

- The integration results may differ from those obtained by another instrument having a different integration method, if load fluctuates considerably.

Flow of Operations

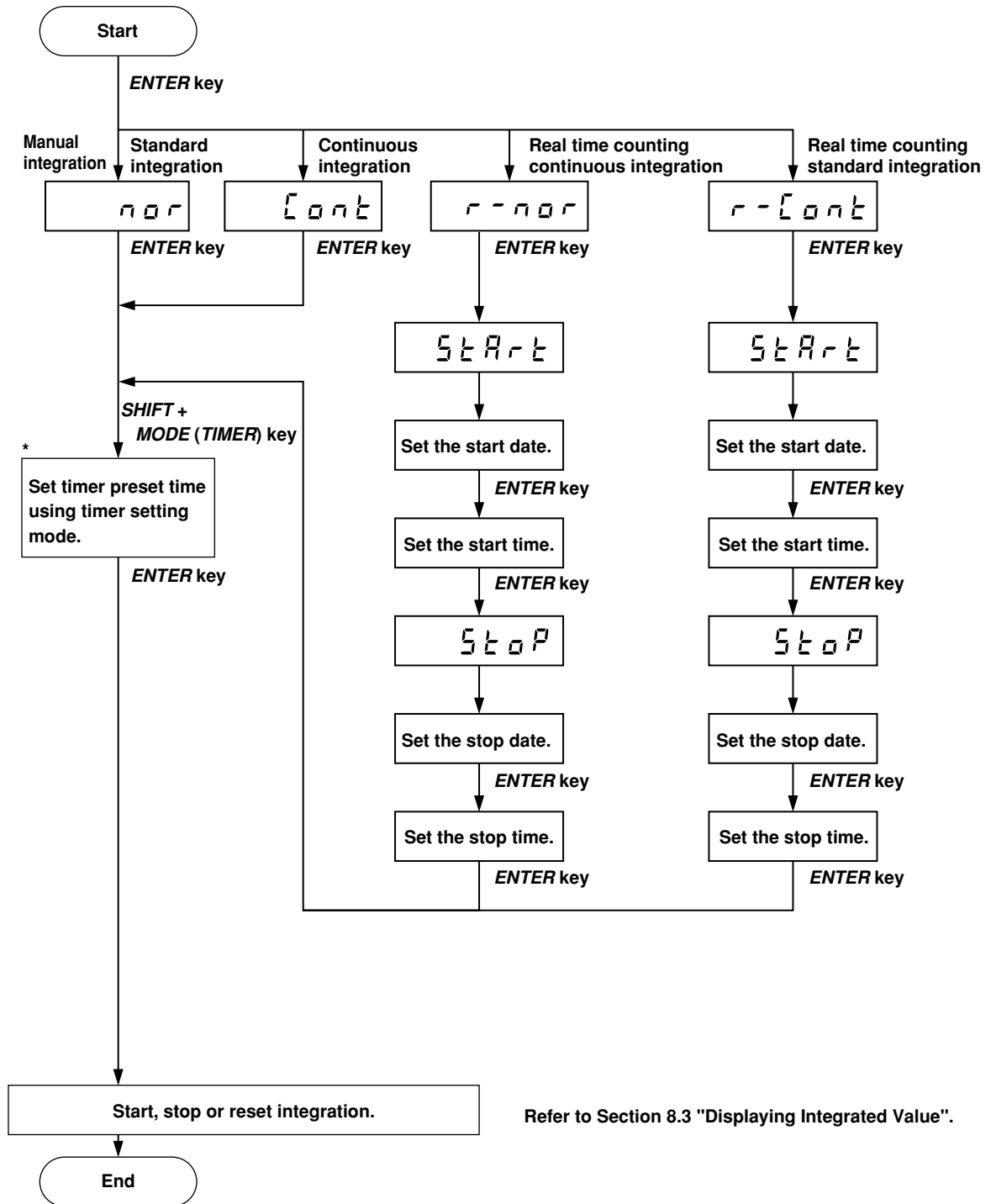

\* If you are using manual integration mode, set the timer preset time to "000" hour and "00" minute.

## Common Operations for All Integration Modes (Setting the Date, Time and Integration Timer)

### Shifting the Blinking Position

The blinking position can be shifted to the left or right by pressing the < or > key. Pressing the < key causes the digit to the left of the currently blinking digit to blink, and pressing the > key causes the digit to the right of the currently blinking digit to blink. The blinking position wraps around in both directions.

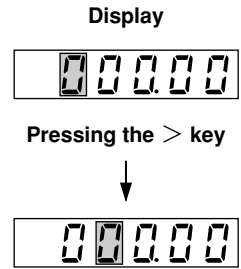

### Setting a Value

To set a value of the blinking digit, press the ^ or v key. Pressing the ^ key changes the value in the order 1, 2, 3 ... 9, 0 and back to 1. However, in the time setting, the value of the second lowest digit changes in the order 1, 2, 3, 4, 5, 0 and 1. Pressing the v key changes the value in the opposite direction.

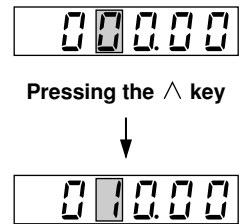

### Confirming Entry

After setting the date (or time or integration timer), press the **ENTER** key.

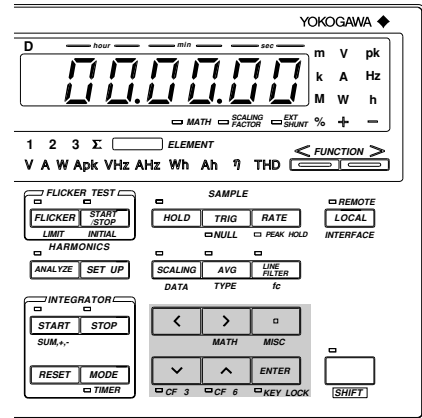



## Display Resolution during Integration

The display resolution for integrated values is 500000 counts. The decimal point shifts automatically according to the elapsed time of integration, constantly maintaining high measurement accuracy.

The decimal point shifting timing is determined automatically according to the selected voltage and current measuring ranges. After the rated value is set for both voltage and current measuring ranges, the decimal point shifts when the integrated value exceeds 500000 counts. However, the minimum measurement unit is 1/1000 times the power range which is determined by the rated voltage and current ranges, and the maximum measurement unit is "MWh". For instance, the elapsed time of integration and integrated value are displayed as follows when the voltage and current measuring ranges are 100 V and 5 A respectively.

| Elapsed Time |    |    | Integrated Value |         |     |
|--------------|----|----|------------------|---------|-----|
| H            | M  | S  |                  |         |     |
|              |    | 0  | 0.00000          | mWh     |     |
|              |    | 2  | 277.778          | mWh     |     |
|              |    | 3  | 416.667          | mWh     |     |
|              |    | 4  | 555.56           | mWh     |     |
|              |    | ⋮  |                  |         |     |
|              |    | 7  | 972.22           | mWh     |     |
|              |    | 8  | 1.11111          | Wh      |     |
|              |    | ⋮  |                  |         |     |
|              |    | 36 | 5.00000          | Wh      |     |
|              |    | 37 | 5.1389           | Wh      |     |
|              |    | ⋮  |                  |         |     |
|              | 10 | 0  | 50.0000          | Wh      |     |
|              | 10 | 1  | 50.139           | Wh      |     |
|              |    | ⋮  |                  |         |     |
|              |    | ⋮  |                  |         |     |
|              | 1  | 0  | 0                | 500.000 | Wh  |
|              | 1  | 0  | 1                | 500.14  | Wh  |
|              |    | ⋮  |                  |         |     |
|              | 2  | 0  | 0                | 1.00000 | kWh |
|              |    | ⋮  |                  |         |     |
|              | 6  | 0  | 0                | 3.00000 | kWh |
|              |    | ⋮  |                  |         |     |
|              | 10 | 0  | 0                | 5.00000 | kWh |

## Current Integration

- As explained earlier, there are three measurement modes for measurement of current; RMS, MEAN and DC. Likewise, there are three types of current integration, corresponding to the three types of measurement. (Refer to Section 8.1 "Overview of Integrator Functions" (page 8-4).) When the measuring mode is DC, the polarity is also displayed. This feature is convenient for measuring battery charging/discharging.
- If the current measuring range is RMS or MEAN and the input current is below 0.3% of the rated value of the range, integration will be carried out with the input current considered to be "0".

## 8.2 Setting Integration Modes

### Setting Integration Mode and Integration Timer

#### Setting the Mode

1. Press the **MODE** key.

"n o r" will be displayed on display A. The currently selected integration mode is displayed on display B. Pressing the  $\wedge$  key changes the mode in the following order, and pressing the  $\vee$  key changes it in the opposite direction.

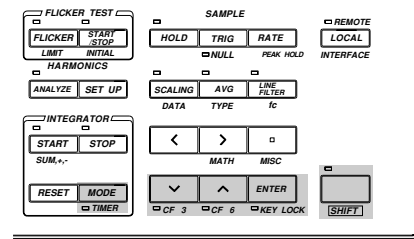

| Display B       | Description                                    |
|-----------------|--|
| n o r (default) | Manual or standard integration mode            |
| [ o n t         | Continuous integration mode                    |
| r - n o r       | Real time counting standard integration mode   |
| r - [ o n t     | Real time counting continuous integration mode |

After the desired integration mode has been selected, press the **ENTER** key.

2. If "r - n o r" (real time counting standard integration mode) or "r - [ o n t" (real time counting continuous integration mode) is selected as integration mode, the following will be displayed on each display.

| Display A   | Display B            | Display C                | Display D                  |
|---|----------------------|--------------------------|----------------------------|
| r - n o r<br>(Real time counting standard integration mode)     | 5 t A r t<br>5 t o P | 9 5.0 10 1<br>9 5.0 10 1 | 0 0 0 0 0 0<br>0 0 0 0 0 0 |
| r - [ o n t<br>(Real time counting continuous integration mode) | 5 t A r t<br>5 t o P | 9 5.0 10 1<br>9 5.0 10 1 | 0 0 0 0 0 0<br>0 0 0 0 0 0 |

#### Setting the Timer Preset Time

3. Press the **TIMER** key (**SHIFT + MODE**).

The timer setting mode is now in operation. The time currently set will be displayed on display A, with the digit on the extreme left blinking, and the INTEG TIMER indicator LED will light up.



4. Set the desired time as follows.

Press the  $\lt$  or  $\gt$  key until the digit for which you wish to set a value is blinking, then press the  $\lt$  or  $\gt$  key to set the desired value. Refer to Section 8.1 "Overview of Integrator Functions" (page 8-6). (When using manual integration mode, set the time to "000.00".)

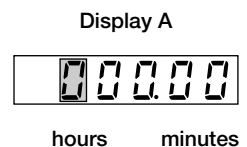

Maximum time allowed: 999 (hours) 59 (minutes)

5. When the desired time has been set, press the **ENTER** key.

The **TIMER** indicator LED located below the **MODE (TIMER)** key will be lit, indicating that the time has been confirmed.

## Integration Using Real Time Counting Standard Integration Mode (r - n o r) or Real Time Counting Continuous Integration Mode (r - [ o n t)

When real time counting continuous mode is used, an error occurs if integration is started with the timer preset time set to "000.00".

### Setting the Start and Stop Date and Time

#### Setting the Start Date

- "S t R t" is displayed on display B and the start date currently set is displayed on display C. Use the  $\wedge$ ,  $\vee$ ,  $<$  and  $>$  keys to set the desired start date. Refer to Section 8.1 "Overview of Integrator Functions" (page 8-6).

Display C

year month day

- Press the **ENTER** key.

#### Setting the Start Time

- The start time currently set is displayed on display D. Use the  $\wedge$ ,  $\vee$ ,  $<$  and  $>$  keys to set the desired start time.
- Press the **ENTER** key. "S t o P" is now displayed on display B.

Display D

hours minutes second

#### Setting the Stop Date

- The stop date currently set is displayed on display C. Use the  $\wedge$ ,  $\vee$ ,  $<$  and  $>$  keys to set the desired stop date.
- Press the **ENTER** key.

Display C

#### Setting the Stop Time

- The stop time currently set is displayed on display D. Use the  $\wedge$ ,  $\vee$ ,  $<$  and  $>$  keys to set the desired stop time.
- Press the **ENTER** key.

Display D

When both start and stop times have been set, set the timer preset time as described in "Setting the Timer Preset Time" on the previous page.

### Note

- If the stop date or time is before the start date or time, an error code "E r r 12" will be displayed. It is not possible to set a stop date or time that is before the start date or time.
- Years whose final two digits are less than "96" will be treated as 21st century years.

|    |   |      |
|----|---|------|
| 00 | → | 2000 |
|    | ⋮ | ⋮    |
| 95 | → | 2095 |
| 96 | → | 1996 |
|    | ⋮ | ⋮    |
| 99 | → | 1999 |

# 8.3 Displaying Integrated Value

## Function Setting

### Operating the **FUNCTION** Key

Press the **FUNCTION** key below display A to light up the **INTEG TIME** indicator LED.

Press the **FUNCTION** key below display D to select **Wh** or **Ah**. For details, refer to Section 4.3 "Selecting What to Display on Digital Displays" (page 4-10.)

### Operating the **ELEMENT** Key

Press the **ELEMENT** key below display D to select the element to be measured. For details, refer to Section 3.2 "Setting Wiring System" (page 3-2.)

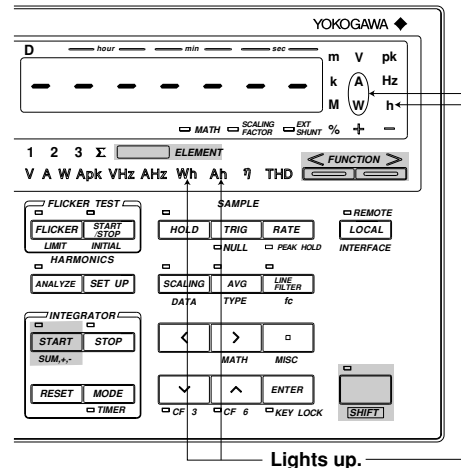

### Setting **WIRING** System

Press the **WIRING** key to select the correct wiring system. For details, refer to Section 3.2 "Setting Wiring System" (page 3-2).

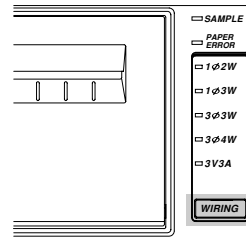

### Displaying Polarity of Integration

Polarity can be changed each time the **SUM, +, -** key (**SHIFT + START**) is pressed. If the function is **Ah** or **Wh**, selection of **+** or **-** causes the corresponding polarity indicator (at the right of Display D) to light up. (You can also change the polarity while a different function is selected, but the LED indicators will not light.)

## Starting, Stopping and Resetting Integration

The elapsed time of integration is displayed on display A, and the integrated value is displayed on display D.

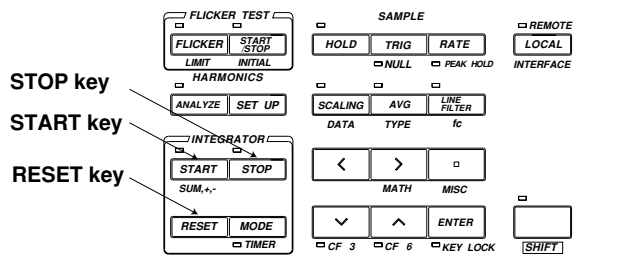

### Starting Integration

Press the **START** key.

Integration will start. Make sure that the **START** indicator LED is lit. In real time counting standard or continuous mode, the **START** indicator LED blinks, indicating that the instrument is in standby state. (Integration will start automatically when the start date and time is reached.) If the stop date and time has already passed, integration will not start even if the **START** key is pressed, and an error code "E r r 4 B" will be displayed.

**Stopping Integration**

Press the **STOP** key.

- If the **STOP** key is pressed while integration is in progress, integration will be paused. The instrument holds the integration time and integrated value of the stop point until the **START** key is pressed again.
- The STOP indicator LED lights up when the **STOP** key is pressed.
- When the integrated power reaches the maximum, integration will stop and the instrument holds the integrated value and integration time.

**Resetting Integration**

Press the **RESET** key after integration has been stopped.

- The integrated value and integration time will be reset.

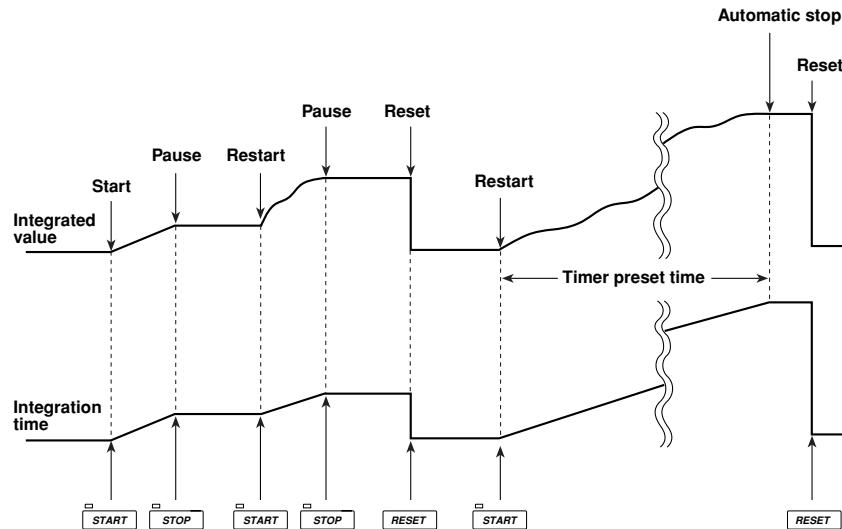

**Integration Overflow Display**

If the integrated value reaches the maximum ( $\pm 999999$  MWh or  $\pm 999999$  MAh), integration will stop and the instrument will hold that value.

**Holding the Integrated Value**

Pressing the **HOLD** key during integration will light up the HOLD indicator LED and hold the integrated value of the time at which the **HOLD** key is pressed. To update the displayed value, press the **TRIG** key. For details, refer to Section 8.4 "Precautions Regarding Use of Integrator Function" (page 8-12.)

**Display Content and Range**

| Display A                                   | Display B    | Display C    | Display D  |
|---|--------------|--------------|--|
| Elapsed time of integration or active power | Active power | Active power | Integrated value<br>Maximum $\pm 999999$ MWh or $\pm 999999$ MAh |

**Note**

- Display A is valid when the function is set to "INTEG TIME" or "W" (active power). Otherwise, "-----" will be displayed.
- Displays B and C are valid only when their function is set to "W" (active power). Otherwise, "-----" will be displayed.
- "-----" will be displayed on displays B and C for the first measurement after the **START** key is pressed.
- The previous measured value (not the latest measured value) will be displayed just after the **STOP** key is pressed.

**Displaying the Polarity of the Integrated Value**

Integrated active power sometimes decrease in the case of battery discharge. If the integrated power is negative, "-" will be displayed in front of the integrated value.

## 8.4 Precautions Regarding Use of Integrator Function

### Integration When Display Hold is ON

When the **HOLD** key has been pressed to activate the display update hold function, i.e. when the HOLD indicator LED is lit, integrated values displayed and output through a communications interface are on hold, but integration is still carried out whether the display update hold function is ON or OFF. The SAMPLE indicator LED continues to blink.

- As shown in Fig. (a), if integration is started while the display update hold function is ON, the displayed integrated value remains unchanged. However, as soon as the display update hold function is turned OFF or the **TRIG** key is pressed, the integrated value accumulated up to that moment will be displayed.
- As shown in Fig. (b), if integration is stopped while the display update hold function is ON, the displayed integrated value remains unchanged. However, as soon as the display update hold function is turned OFF or the **TRIG** key is pressed, the integrated value obtained when the **STOP** key was pressed will be displayed.

Fig. (a)

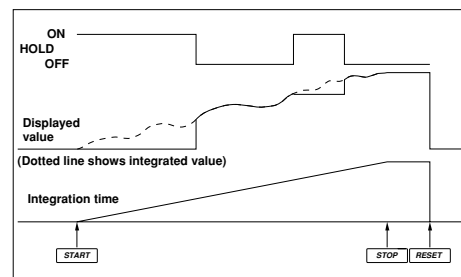
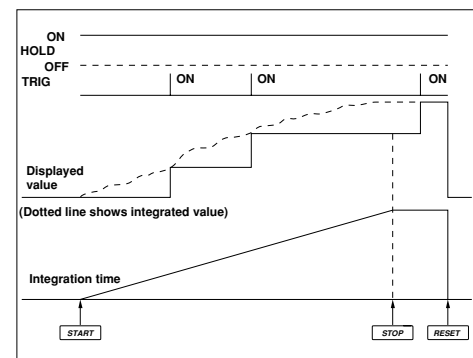

Fig. (b)



### Backup During Power Failures

If there is a power failure while integration is in progress, the integrated value and integration time will be backed up.

- In this case, integration will remain stopped even if power is restored or the **START** key is pressed. To restart integration, first press the **RESET** key to cancel integration, then press the **START** key.
- When power is restored after a power failure, the integrated value and elapsed time of integration up to the time of the power failure will be displayed.

### Panel Key Operation During Integration Mode

During integration mode, certain key operations are restricted so that settings are not accidentally changed when operating keys are pressed. The table below show these restrictions.

| Operation key           | (START LED)<br>(STOP LED)  | Integration in progress                   |   |   |
|-------------------------|--|---|---|---|
|                         |  | Integration stopped<br>Not lit<br>Not lit | Integration state<br>Lit<br>Not lit   | Integration paused<br>Not lit<br>Lit  |
| MODE                    | <b>RMS,MEAN,DC</b>   | ○   | V : x<br>A : x  | V : x<br>A : x  |
|                         | <b>AVG<br/>SCALING</b>   | ○<br>○                                    | x<br>○  | x<br>○  |
| SAMPLE                  | <b>HOLD<br/>TRIG</b> (display update hold ON)<br><b>RATE</b>         | ○<br>○<br>○                               | ○<br>○<br>△   | ○<br>○<br>△   |
| RANGE                   | <b>VOLTAGE AUTO</b><br><, ><br><b>CURRENT AUTO</b><br><, >           | ○<br>○                                    | x<br>x  | x<br>x  |
| CF<br>LINE FILTER<br>fc |  | ○<br>○<br>○                               | x<br>x<br>△   | x<br>x<br>△   |
| FILTER                  |  | ○   | ○   | ○   |
| DATA SETTING            | <b>SCALING (DATA)<br/>MODE (TIMER)</b><br>^, v, <, ><br><b>ENTER</b> | ○   | ○<br><small>In the case of the <b>TIMER</b> key,<br/>key operation is not possible,<br/>but the timer preset time can<br/>be displayed.</small> | ○<br><small>In the case of the <b>TIMER</b> key,<br/>key operation is not possible,<br/>but the timer preset time can<br/>be displayed.</small> |
|                         | <b>FUNCTION</b> (Display A)<br><b>FUNCTION</b> (Displays B, C, D)    | x<br>○                                    | x<br>○  | x<br>○  |
| WIRING SYSTEM           | <b>WIRING</b>  | ○   | ○   | ○   |
| INTEGRATOR              | <b>START<br/>STOP<br/>RESET</b>                                      | ○<br>x<br>○                               | x<br>○<br>x   | ○<br>x<br>○   |

x : Key operation is not possible.

○ : Key operation is possible.

△ : Confirmation only is possible

- Error code "Err 13, 42, 44, 45" will appear on display D if any key that cannot be operated is pressed.
- It is not possible to reset the integrated value while integration is in progress. To reset the integrated value, press the **STOP** key to interrupt integration, then press the **RESET** key.
- To use keys whose operation is invalidated while integration is in progress, press the **STOP** key to interrupt integration, then press the **RESET** key to reset the displayed integrated value.
- If integration is started while auto range setting mode is active, the range setting mode will be switched to manual range setting mode, but the measuring range will remain unchanged.

### **Integrated Value when Instantaneous Measured Value Exceeds Measurement Limits**

If the instantaneous measured value exceeds the measurement limits, computation is carried out as follows. In this case, it is not possible to obtain correct integrated values.

- If the instantaneous input exceeds 3.5 times the rated value of the measuring range when the crest factor is “3”, the measured value is considered to be 3.5 times the rated value of the measuring range when computing the integrated value.
- If the instantaneous input exceeds 7 times the rated value of the measuring range when the crest factor is “6”, the measured value is considered to be 7 times the rated value of the measuring range when computing the integrated value.



## 9.1 Operating the Harmonic Analysis Function (Optional)

To operate the harmonic analysis function from within a normal measurement operation, you have to set the harmonic analysis mode first, then make PLL source (input to be used as the fundamental frequency), display type and harmonic order settings.

### Setting the Harmonic Analysis Mode

#### Operating the **ANALYZE** key

Press the **ANALYZE** key. The ANALYZE indicator LED will light up, indicating that the harmonic analysis mode is activated.

To return to the normal measurement mode, press the **ANALYZE** key once more. The ANALYZE indicator LED will go out, indicating that the normal measurement mode is now active.

In the harmonic analysis mode, RMS mode is always selected as the measuring mode. Even if the mode is switched from the harmonic analysis mode to the normal measurement mode, RMS mode stays as the measuring mode.

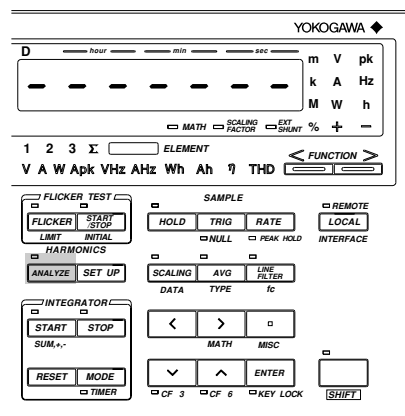

#### Note

- It is not possible to activate the harmonic analysis mode while integration is in progress (i.e. START indicator LED: lit) or integration is being interrupted (i.e. STOP indicator LED: lit). If such attempt is made, an error "Err 13" will occur. In this case, press the **STOP** key (to interrupt integration) then **RESET** key, and finally press the **ANALYZE** key.
- It is not possible to start integration if the harmonic analysis mode is active. If such an attempt is made, an error "Err 15" will occur.
- It is not possible to activate the harmonic analysis mode during flicker measurement (i.e. FLICKER indicator LED: lit). To activate the harmonic analysis mode, first you have to return to normal measurement. To do this, press the **START/STOP** key to stop flicker measurement, press the **INITIAL (SHIFT + START/STOP)** key to initialize the instrument, then press the **FLICKER** key. Finally, press the **ANALYZE** key to activate the harmonic analysis mode.
- The accuracy varies according to the selected crest factor. For a detailed description, refer to Chapter 16.

To carry out measurement in accordance with IEC 1000-3-2, set each item as follows. For a description of the setting method, refer to the following pages.

| Harmonic                                    | Analysis Window Width | Averaging | Anti-aliasing Filter | Analysis Order |
|---|-----------------------|-----------|----------------------|----------------|
| Steady-state harmonic                       | 4, 8 or 16            | OFF or ON | ON                   | 40 or higher   |
| Fluctuating harmonic (within limit)         | 4, 8 or 16            | ON        | ON                   | 40 or higher   |
| Fluctuating harmonic (likely outside limit) | 16                    | ON        | ON                   | 40 or higher   |

Setting the PLL Source

For harmonic analysis, it is necessary to select the input to be used as the fundamental frequency (PLL source) for PLL synchronization. (PLL stands for Phase Locked Loop.)

1. Press the **SET UP** key.  
Press the  $\wedge$  or  $\vee$  key until "5 4 n 1" is displayed on display C.
2. Press the **ENTER** key.
3. Pressing the  $\wedge$  or  $\vee$  key changes the PLL source displayed on display D in the following order, so select the desired source. (Default is  $U_1$ .)

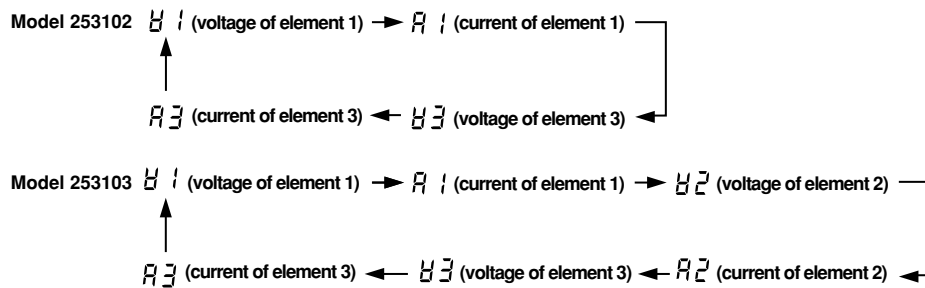
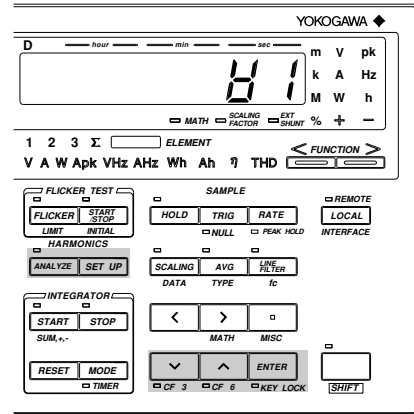

4. Press the **ENTER** key.

**Note**

- If the fundamental frequency of PLL source cannot be measured due to fluctuations or distortions, it is not possible to obtain correct measurement results. In this case, it is suggested voltage with relatively small distortion be selected as the PLL source or turn the filter ON.
- If the amplitude of the input signal selected as the PLL source is smaller than the rated range value, PLL synchronization may sometimes fail. In this case, it is suggested a suitable measurement range be selected so that the input level exceeds 30% of the rated range value.
- If there is no input for the PLL source, "F r Q E r r" will be displayed on display B.

### Setting the Display Type

The fundamental component and each harmonic component of voltage, current or active power is displayed on display B. They are displayed either as measured value or relative harmonic content, so it is necessary to select either measured value or relative harmonic content beforehand. This setting can be made on display D.

1. Press the **SET UP** key.  
Press the  $\wedge$  or  $\vee$  key until "d, 5 P" is displayed on display C.
2. Press the **ENTER** key.
3. Pressing the  $\wedge$  or  $\vee$  key changes the display type displayed on display D in the following order, so select the desired type.  
 H A L U E (displays measured value)  $\rightarrow$   
 % H A L U E (displays relative harmonic content)  $\rightarrow$  H A L U E  $\rightarrow$  ...
4. Press the **ENTER** key.



The equation used to calculate the harmonic content is given below.

$$\text{Harmonic content} = \frac{\text{Each harmonic component}}{\text{Fundamental component}} \times 100 (\%)$$

**Note**

- If relative harmonic content is selected, " - - - - - " will be displayed on display B if harmonic order 1 (fundamental) has been selected.
- When "% H A L U E" is selected, the % LED on display B will light up.

### Setting the Harmonic Display Order

Display A is used to select the order of the harmonic data to be displayed on display B and C.

**Operating the  $\wedge$  or  $\vee$  Key**

Press the  $\wedge$  and  $\vee$  keys to select the order of the harmonic data to be displayed on display B or C. Orders from the 1st to the one set in "Setting the Upper limit of the Harmonic Order" (page 9-4) can be set (maximum order: 50th).

However, due to the fundamental frequency of the PLL source becoming large or from turning the anti-aliasing filter to ON, the Maximum analysis order changes, sometimes resulting in the upper limit of the harmonic order to become larger than the Maximum analysis order. In this case, if the display order is set to a value between the Maximum analysis order and the upper limit of the harmonic order, " - - - - - " will be displayed on display B or C.

For details of the maximum order, refer to Section 16, "Specifications".

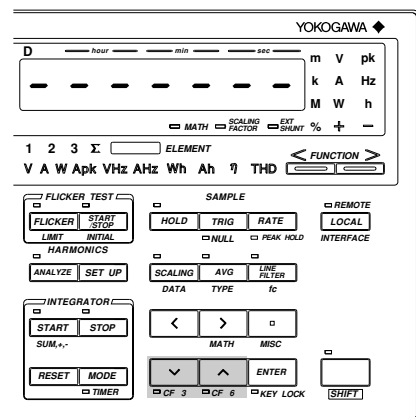

**Note**

- The **ELEMENT** and **FUNCTION** keys located below display A can be used to decrease (**ORDER DOWN**) and increase (**ORDER UP**) the harmonic order respectively. However, it is not possible to change harmonic order fast.

### Setting the Upper Limit of the Harmonic Order

The upper limit of the harmonic order can be set as follows. This setting will be reflected in the equations used to calculate fundamental wave + harmonics and harmonic distortion for voltage, current and power.

#### Operating the **SET UP** Key

1. Press the **SET UP** key.  
Press the  $\wedge$  or  $\vee$  key until "order" is displayed on display C.
2. Press the **ENTER** key.
3. Pressing the  $\wedge$  or  $\vee$  key changes the harmonic order displayed on display D in the following order, so select the desired upper limit of the harmonic order.  
50  $\rightarrow$  1  $\rightarrow$  2  $\rightarrow$  3  $\rightarrow$  ...  $\rightarrow$  49 and back to 50
4. Press the **ENTER** key.

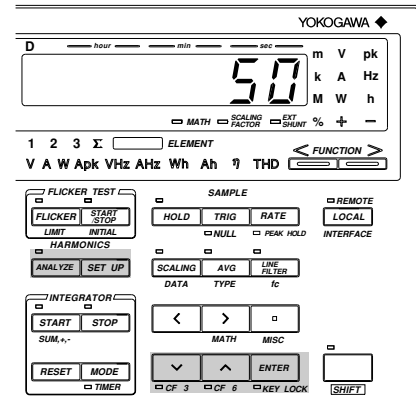

An order from 1st to 50th can be set.

If the maximum harmonic order determined by the anti-aliasing filter is smaller than the upper limit of the harmonic order, "-----" will be displayed on display B or C for the harmonic display order exceeding the maximum harmonic order determined by the anti-aliasing filter.

For details of the maximum order, refer to Section 16, "Specifications".

### Setting the Anti-aliasing Filter

When waves are input continuously and converted to digital data using A/D converter, if a wave having a frequency of less than 1/2 of the sampling frequency is input, this wave is recognized as a wave in low-frequency band that does not exist. This symptom is known as aliasing. Aliasing causes various problems, including an increase in measurement error and improper measurement of the phase angle. To prevent this aliasing, an anti-aliasing filter is used.

#### Operating the **LINE FILTER** key

Press the **LINE FILTER** key once. The FILTER indicator LED will light up, indicating that the anti-aliasing filter is active.

To deactivate the filter, press the **LINE FILTER** key once more. The FILTER indicator LED will go out, indicating that the filter is not active any more. If the anti-aliasing filter is active, analysis accuracy and the maximum harmonic order change. For details, refer to Section 16, "Specifications".

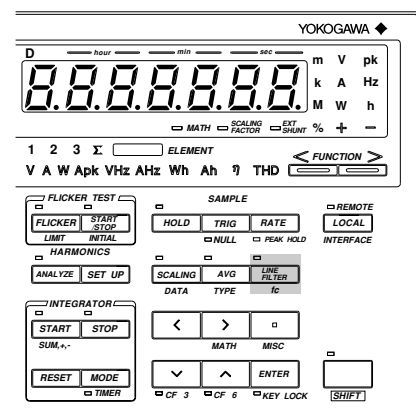

#### Note

- Setting of the anti-aliasing filter is only possible in harmonic analysis mode. The anti-aliasing filter is **not the same as the filter used in the normal measurement mode**, and the **ON/OFF state of each filter is maintained independently**.
- The anti-aliasing filter's cut-off frequency is fixed at 5.5 kHz.
- For details of the sampling frequency, refer to Section 16, "Specifications".

### Measuring with Frequency Filter ON

Harmonic analysis may not function properly if the PLL source wave contains harmonics or noise. In this case, it is recommended that the frequency filter be turned ON to eliminate such harmonics or noise during harmonic analysis.

1. Press the **MISC** (**SHIFT** + **□**) key.  
Press the **∧** or **∨** key until "F - F, L L" is displayed on display D.
2. Press the **ENTER** key.  
"F - F, L L" will move to display C, and "□ F F" on display D begins to blink.
3. Press the **∧** or **∨** key to display "□ n", then press the **ENTER** key.
4. To turn the frequency filter OFF, press the **∧** or **∨** key to display "□ F F" on display D, then press the **ENTER** key.

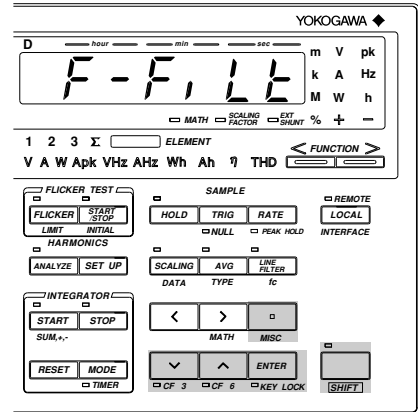

### Setting the Harmonic Analysis Window Width

Set the number of waveforms whose data is to be used for harmonic analysis (fundamental input frequency: 40 to 70 Hz).

1. Press the **SET UP** key.  
Press the **∧** or **∨** key until "□, □ L H" is displayed on display C.
2. Press the **ENTER** key.
3. Press the **∧** or **∨** key. The window width displayed on display D will change in the following order, so select the desired window width.  
16 → 8 → 4 → 2 → 1 → 16 → ...  
The default is 16.
4. Press the **ENTER** key.

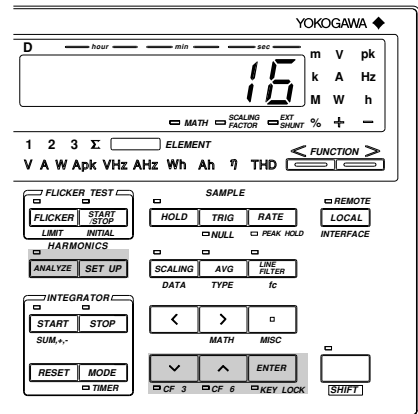

**Note**

- "E r r - L □" will be displayed on display D and " - - - - -" is displayed as the measurement result if the fundamental input frequency drops below 40 Hz when the window width has been set to "1" or it drops below 20 Hz when the window width has been set to "2".

## 9.2 Selecting What to Display on Digital Displays (Optional)

Harmonic analysis results are displayed on displays A, B, C and D.

The information to be displayed on each display can be selected with the **FUNCTION** key and **ELEMENT** key below the display.

### Operating the **FUNCTION** Key

This key is used to set the function to be displayed. Some functions (those which are not shown below and on the following pages) cannot be set in harmonic analysis mode. If a function which cannot be set in harmonic analysis mode has been set in the normal measurement mode, V (voltage) will be selected automatically.

V (voltage) will be also selected automatically if the mode is switched from harmonic analysis mode back to normal measurement mode or if a function which cannot be set in the normal measurement mode has been set.

### Operating the **ELEMENT** Key

This key is used to set the element to be displayed.

### Default Function and Element

When the mode is switched from normal measurement mode to harmonic analysis mode, settings made in normal measurement mode will be retained, except for filter setting. This also applies when the mode is switched from harmonic analysis mode to normal measurement mode.

### Information on Each Display

For details, refer to the next pages.

Display A

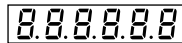

- The harmonic order of the measured/analysis data displayed on display B or C is displayed.

Display B

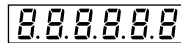

- The fundamental component and each harmonic component of voltage, current and active power are displayed as measured value or relative harmonic content.

Display C

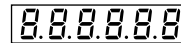

- The fundamental component and each harmonic component of voltage, current and active power are displayed as measured value are displayed.
- The reactive power, apparent power and power factor of the fundamental (1st harmonic) are displayed.
- The phase angle between the fundamental of voltage and current, and phase angle of each higher harmonic in relation to the fundamental of voltage or current are displayed.

Display D

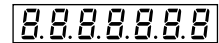

- The voltage, current and active power of fundamental + higher harmonics are displayed.
- The fundamental frequency of the input set as the PLL source is displayed.
- The harmonic distortion (THD) of voltage and current is displayed.

**Display A**

The harmonic order of the data displayed on display B or C is displayed. Orders from the 1st up to the upper limit of the harmonic order (maximum: 50th) can be displayed.

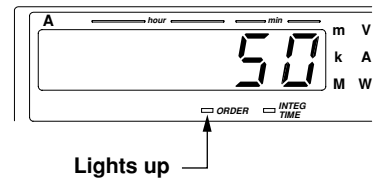

However, due to the fundamental frequency of the PLL source becoming large or from turning the anti-aliasing filter to ON, the Maximum analysis order changes, sometimes resulting in the upper limit of the harmonic order to become larger than the Maximum analysis order. In this case, if the display order is set to a value between the Maximum analysis order and the upper limit of the harmonic order, " - - - - - " will be displayed on display B or C. For details of the maximum order, refer to Section 16, "Specifications" (page 16-1.)

**Note**

- For the order setting method, refer to Section 9.1 "Operating the Harmonic Analysis Function" (page 9-3.)

**Display B**

The following are displayed on display B.

- Fundamental component and each harmonic component of voltage corresponding to the harmonic order displayed on display A (as measured value or relative harmonic content)
- Fundamental component and each harmonic component of current corresponding to the harmonic order displayed on display A (as measured value or relative harmonic content)
- Fundamental component and each harmonic component of active power corresponding to the harmonic order displayed on display (as measured value or relative harmonic content)

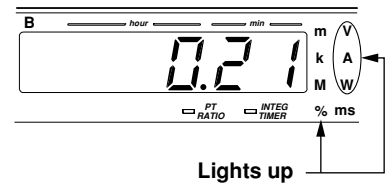

Information displayed on display B changes in the following order.

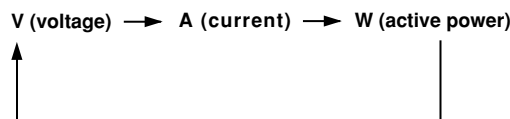

**Note**

- For display type setting method, refer to Section 9.1 "Operating the Harmonic Analysis Function" (page 9-3.)

**Display C**

The following are displayed on display C.

- Fundamental component and each harmonic component of voltage corresponding to the harmonic order displayed on display A (as measured value)
- Fundamental component and each harmonic component of current corresponding to the harmonic order displayed on display A (as measured value)
- Fundamental component and each harmonic component of active power corresponding to the harmonic order displayed on display (as measured value)
- Reactive power of the fundamental (1st)
- Apparent power of the fundamental (1st)
- Power factor of the fundamental (1st)
- Phase angle between the fundamental of voltage and current
- Phase angle of each higher harmonic in relation to the fundamental of voltage or current



## 9.2 Selecting What to Display on Digital Displays (Optional)

Information displayed on display C changes in the following order.

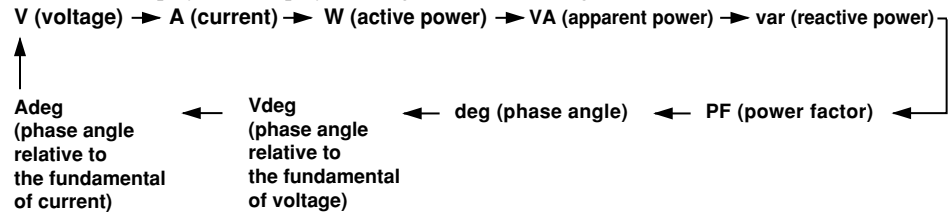

### Note

- For a description of how to operate the display for the phase angle, refer to Section 9.6 "Displaying the Phase Angle between the Fundamentals" (page 9-12) or Section 9.7 "Displaying the Phase Angle of Each Higher Harmonic in Relation to the Fundamental of Voltage or Current" (page 9-13.)
- When VA, var, PF or deg is selected, " - - - - -" will be displayed if an order other than 1st order is selected on display A.

## Display D

The following are displayed on display D.

- Total rms value of voltage (regardless of the order displayed on display A)
- Total rms value of current (regardless of the order displayed on display A)
- Total rms value of active power (regardless of the order displayed on display A)
- Fundamental frequency of the input selected as the PLL source
- Harmonic distortion of voltage
- Harmonic distortion of current

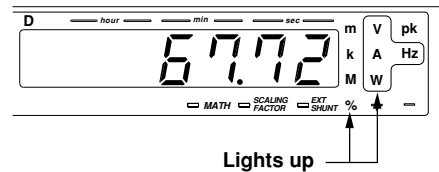

Information displayed on display D changes in the following order.

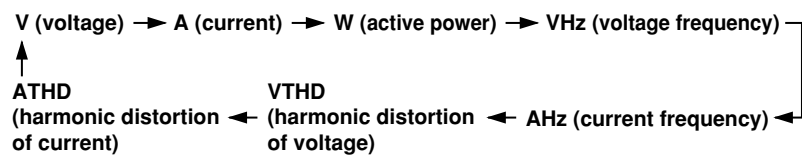

### Note

- For computing equations for voltage, current and active power, refer to Section 9.4 "Displaying Fundamental + Higher Harmonics of Voltage, Current and Active Power" (page 9-10.)
- For computing equation for relative harmonic distortion, refer to Section 9.5 "Displaying the Harmonic Distortion (THD)" (page 9-11.)
- If VTHD or ATHD is selected, the % indicator LED will also light up to indicate that the data is displayed in units of %.

## Sample Rate

Set the sample rate in the same way as for normal measurement operations.



## 9.3 Displaying Fundamental and Each Harmonic of Voltage, Current, Active Power, Apparent Power, Reactive Power and Power Factor as Measured Value or Relative Harmonic Content (Optional)

The fundamental component and each harmonic component of voltage, current and active power are displayed as measured value or relative harmonic content on display B; they are displayed as measured value on display C. In addition, the fundamental component of reactive power, apparent power and power factor is also displayed.

### Function Setting

1. Press the **FUNCTION** key below display B or C to select **V (voltage)**, **A (current)** or **W (active power)** for display, or press the **FUNCTION** key below display C to select **VA (apparent power)**, **var (reactive power)** or **PF (power factor)** for display.

For details, refer to Section 9.2 "Selecting What to Display on Digital Displays" (pages 9-7 and 9-8).

### Setting Element to be Displayed

2. Press the **ELEMENT** key below display B or C
  - Display B  
Select element 1, 2 or 3.  
However,  $\Sigma$  is effective only when the fundamental of V, A or W is selected.
  - Display C  
Select element 1, 2, 3 or  $\Sigma$ .  
However,  $\Sigma$  is effective only when the fundamental of V, A, W, VA, var or PF is selected.

For details, refer to Section 9.2 "Selecting What to Display on Digital Displays" (page 9-6).

### Setting the Harmonic Order

3. Set the harmonic order.  
For details, refer to "Setting the Harmonic Order" (page 9-3).

### Setting the Display Type

4. Use display D to set whether data is to be displayed as measured value or relative harmonic content.  
For details, refer to Section 9.1 "Operating the Harmonic Analysis Function" (page 9-3).  
This function is applicable only to display B. Data is always displayed as measured values on display C, regardless of the display type set in this step.

#### Note

- The minus sign will be displayed for var (reactive power) if the voltage is behind the current.
- In case the displayed active power value becomes less than -99999 on display B and C, the minus sign will not be displayed. However, in the printout and regarding the communications output, the minus sign will be present.

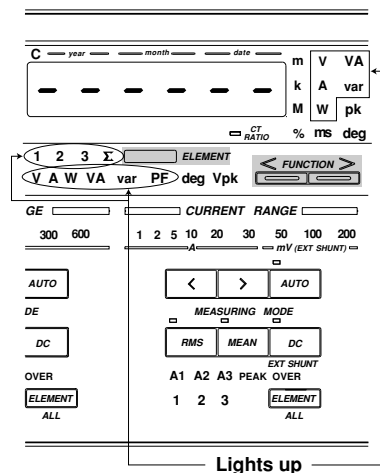
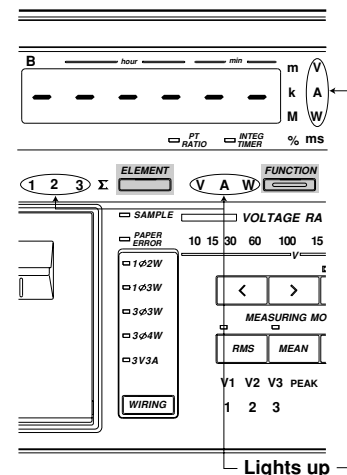

## 9.4 Displaying the Fundamental + Higher Harmonics of Voltage, Current and Active Power (Optional)

The fundamental and higher harmonics of voltage, current and active power are displayed on display D.

### Function Setting

1. Press the **FUNCTION** key below display D to select **V (voltage)**, **A (current)** or **W (active power)** for display.

For details, refer to Section 9.2 "Selecting What to Display on Digital Displays" (page 9-8.)

### Setting the Element to be Displayed

2. Press the **ELEMENT** key below display D to select the element to be displayed: **1**, **2** or **3**.  
If  $\Sigma$  is selected, "-----" will be displayed on display D.

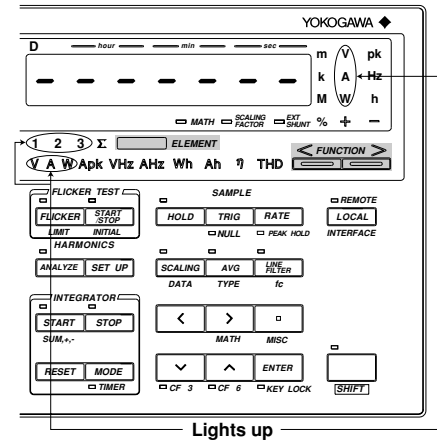

For details, refer to Section 9.2 "Selecting What to Display on Digital Displays" (page 9-6).

### Computing Equation

The fundamental + higher harmonics of voltage, current and active power are calculated using the following equation.

$$V \text{ (voltage)} = \sqrt{\sum_{k=1}^n (V_k)^2} \quad A \text{ (current)} = \sqrt{\sum_{k=1}^n (A_k)^2} \quad W \text{ (active power)} = \sum_{k=1}^n W_k$$

$V_k, A_k, W_k$  : Fundamental or harmonic component of voltage, current and active power

$k$  : Analysis order

$n$  : Maximum order. The maximum possible order varies according to the fundamental frequency of the input set as the PLL source and to whether the anti-aliasing filter is ON or OFF. If this maximum order is smaller than the preset order, the preset order will be used as the maximum order.

### Note

- Total rms value (fundamental + harmonics) obtained in the harmonic analysis mode differs from that obtained in normal measurement mode. The total rms value in harmonic analysis mode is calculated from the fundamental component and the harmonics up to the maximum order as shown in the above equation.

## 9.5 Displaying the Harmonic Distortion (THD) (Optional)

Harmonic distortion (THD) is displayed on display D.

### Function Setting

1. Press the **FUNCTION** key below display D to select **VTHD (harmonic distortion of voltage)** or **ATHD (harmonic distortion of current)**.

For details, refer to Section 9.2 "Selecting What to Display on Digital Displays" (page 9-8).

### Setting the Element to be Displayed

2. Press the **ELEMENT** key below display D to select the element to be displayed; **1, 2** or **3**.

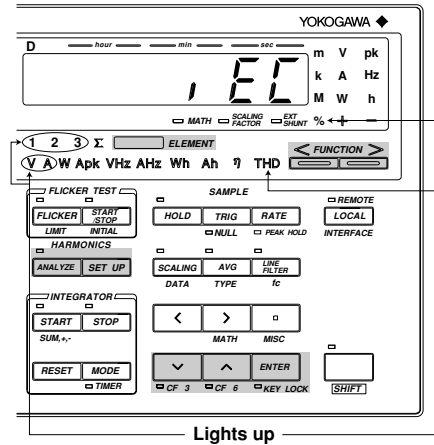

For details, refer to Section 9.2 "Selecting What to Display on Digital Displays" (page 9-6).

### Computing Equation

Harmonic distortion (THD) is calculated using the following equation.

- $\sqrt{\sum_{k=2}^n C_k^2} / C_1$  : Calculates the ratio of the rms value of each component (from the 2nd to the nth) in relation to the fundamental (1st).
- $\sqrt{\sum_{k=2}^n C_k^2} / \sqrt{\sum_{k=1}^n C_k^2}$  : Calculates the ratio of the rms value of each component (from the 2nd to the nth) in relation to the rms value of each component (from the 1st to nth).  
(n: Harmonic order set in "Setting the Harmonic Order")

3. Press the **SET UP** key.  
Press the  $\wedge$  or  $\vee$  key until " $\sqrt{\sum_{k=2}^n C_k^2}$ " is displayed on display C.
4. Press the **ENTER** key.
5. The currently selected computing equation will be displayed on display D. Press the  $\wedge$  or  $\vee$  key to select the desired equation ( $\sqrt{\sum_{k=2}^n C_k^2}$  or  $\sqrt{\sum_{k=1}^n C_k^2}$ ).
6. Press the **ENTER** key.

#### Computation equation

When  $\sqrt{\sum_{k=2}^n C_k^2}$  is selected:

$$\sqrt{\sum_{k=2}^n C_k^2} / C_1$$

When  $\sqrt{\sum_{k=1}^n C_k^2}$  is selected:

$$\sqrt{\sum_{k=2}^n C_k^2} / \sqrt{\sum_{k=1}^n C_k^2}$$

$C_1$  : Fundamental (1st) of V (voltage) or A (current)

$C_k$  : Fundamental or harmonic component of V (voltage) or A (current)

k : Analysis order

n : Maximum order. The maximum order varies according to the fundamental frequency of the input set as the PLL source and to whether the anti-aliasing filter is ON or OFF. If this maximum order is smaller than the preset order, the preset order will be used as the maximum order.

## 9.6 Displaying the Phase Angle between the Fundamentals (Optional)

The phase angle between the fundamentals is displayed on display C.

### Function Setting

1. Press the **FUNCTION** key below display C to select **deg (phase angle)**.

### Setting the Element to be Displayed

2. Press the **ELEMENT** key below display C to select the element to be displayed; **1, 2** or **3**.

The displayed data will vary according to the selected element.

Phase angle of A1 with respect to V1

Phase angle of A2 with respect to V2

Phase angle of A3 with respect to V3

For details, refer to Section 9.2 "Selecting What to Display on Digital Displays" (page 9-6).

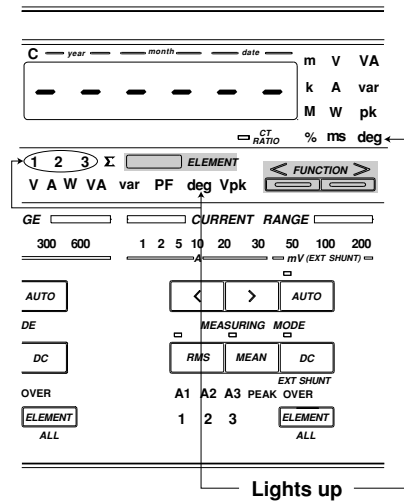

### Setting the Harmonic Order (to the Fundamental)

3. Set the harmonic order displayed on display A to "1". This causes display C to display the phase angle between the fundamentals.

For details, refer to Section 9.1 "Operating the Harmonic Analysis Function" (page 9-3).

### Phase Angle Display Method

4. The phase angle will be displayed according to the method specified in 5.6, "Displaying the Computed Phase Angle" (page 5-7).

## 9.7 Displaying the Phase Angle of Each Higher Harmonic in Relation to the Fundamental of Voltage or Current (Optional)

The phase angle of each harmonic in relation to the fundamental of voltage or current is displayed on display C.

### Function Setting

1. Press the **FUNCTION** key below display C to select **Vdeg** or **Adeg** (phase angle).

For details, refer to Section 9.2 "Selecting What to Display on Digital Displays" (page 9-7).

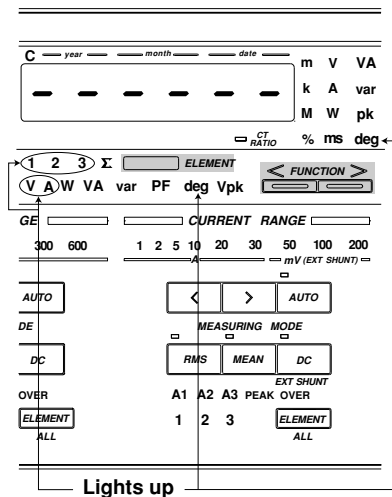

### Setting the Element to be displayed

2. Press the **ELEMENT** key below display C to select which element is to be measured: 1, 2 or 3.

For details, refer to Section 9.2 "Selecting What to Display on Digital Displays" (page 9-6).

### Setting the Harmonic Order

3. Press the  $\wedge$  or  $\vee$  key below display D to set the harmonic order to any value between "2" and the upper limit of the harmonic order.

For details, refer to Section 9.1 "Operating the Harmonic Analysis Function" (page 9-3).

This sets which harmonic the phase angle refers to.

If the harmonic order is set to "1", the phase angle between the fundamentals of the same element will be displayed. In this case, the phase angle will be displayed in the phase angle display method set in "Setting Phase Angle Display Method" (page 5-7).

### Display Method

Phase angle is displayed as follows based on the fundamental.

- When the harmonic is in front of the fundamental:  
000 to 18000
- When the harmonic is behind the fundamental:  
000 to -18000
- When both phases are the same:  
000

### Note

- The **ELEMENT** and **FUNCTION** keys located below display A can be used to decrease (**ORDER DOWN**) and increase (**ORDER UP**) the harmonic order respectively. However, it is not possible to change harmonic order fast.

## 9.8 Displaying the Fundamental Frequency (Optional)

The fundamental frequency of the input selected as the PLL source is displayed on display D.

### Function Setting

1. Press the **FUNCTION** key below display D to select **VHz** (voltage frequency) or **AHz** (current frequency) which has been selected as the PLL source.

For details, refer to Section 9.2 "Selecting What to Display on Digital Displays" (page 9-8).

### Setting the Element to be Displayed

2. Select the same input element here that has been selected as the PLL source in "Setting the PLL Source" (page 9-2).

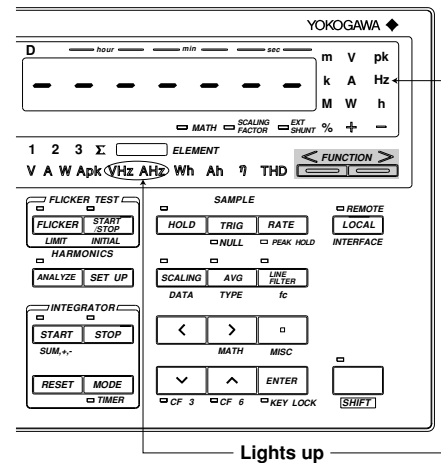

"-----" will be displayed if a function or input element which differs from the PLL source is selected.

## 10.1 Using the Voltage Fluctuation/Flicker Measurement Functions (Optional)

This function enables measurement of voltage fluctuation and flicker, as well as display and print-out of judgment results obtained by comparing the measured data to the specified limits, in accordance with IEC1000-3-3 (Limitation of voltage fluctuations and flicker for instruments with phase input current of 16 A or below). For a description of printing method, refer to Chapter 11 "Printing Using the Built-in Printer", and for a description of output method via a communication interface, refer to Chapter 14 "Using the Communications Functions".

With this instrument, voltage fluctuation is measured using the following methods.

- Direct voltage measurement method
  - Relative steady-state voltage change
  - Maximum relative voltage change
  - Period during which relative voltage change is above the threshold level
- Direct flicker measurement method
  - Short-term flicker value

### Wiring Required for Measurement of Voltage Fluctuation/Flicker

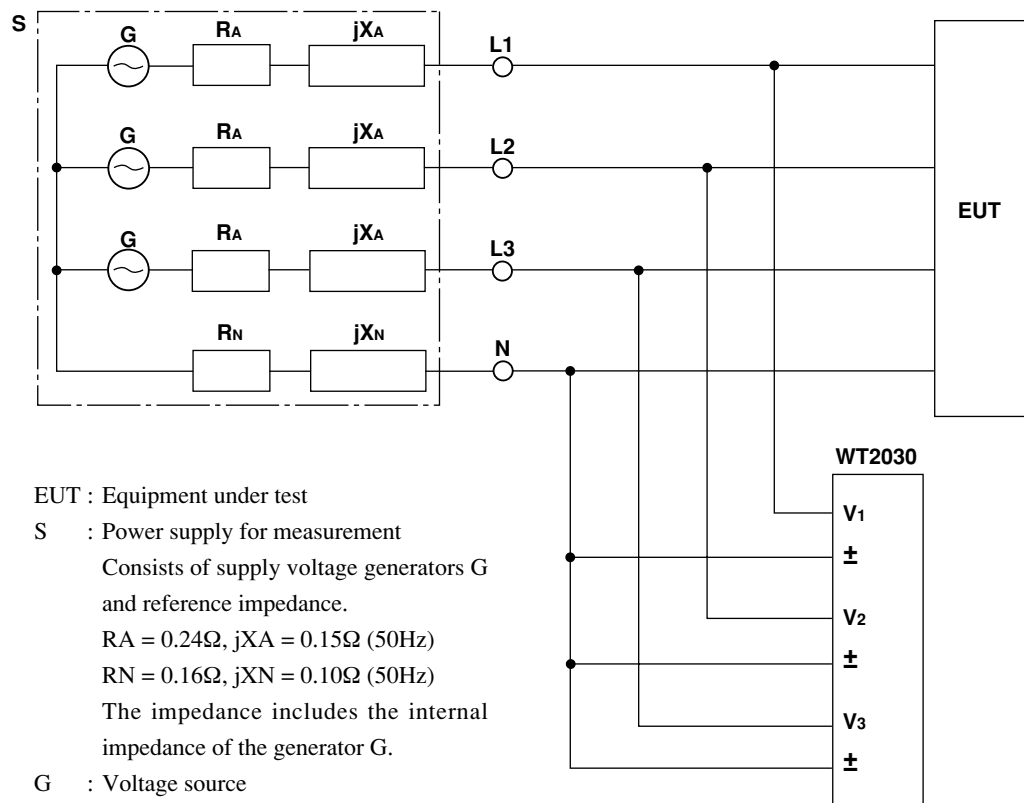

- EUT : Equipment under test
- S : Power supply for measurement  
 Consists of supply voltage generators G and reference impedance.  
 $RA = 0.24\Omega$ ,  $jXA = 0.15\Omega$  (50Hz)  
 $RN = 0.16\Omega$ ,  $jXN = 0.10\Omega$  (50Hz)  
 The impedance includes the internal impedance of the generator G.
- G : Voltage source

In the case of single-phase two-wire system, connect L1, N and EUT to the instrument.

#### Note

- Initialization is performed immediately after the measurement mode is switched from normal measurement to voltage fluctuation/flicker measurement mode. Thus, make sure that wiring of the instrument is complete and supply voltage for measurement is input to the terminal of the instrument before switching to voltage fluctuation/flicker measurement mode.  
 If supply voltage for measurement is input to the terminal of the instrument after the mode has been switched to voltage fluctuation/flicker measurement mode, press the **INITIAL (SHIFT + START/STOP)** key to perform initialization. During initialization, make sure the supply voltage for measurement is constant.
- Set the measuring range so that the input is maintained at 50 to 110% of the measuring range during voltage fluctuation/flicker measurement. If the input exceeds 50 to 110% of the measuring range or peak over occurs during voltage fluctuation/flicker measurement, inaccurate measurement or judgment may result.
- The frequency of the input voltage is measured during initialization. If this frequency is not measured accurately, fluctuation/flicker measurements and determination may not be correct. If voltage is not applied to the element being initialized, the frequency cannot be measured accurately. Select the element to which voltage is being applied using the **ELEMENT** key below display (A, B, C or D possible), then press **SHIFT + START/STOP(INITIAL)** key to reinitialize.

**Flow of Operation**

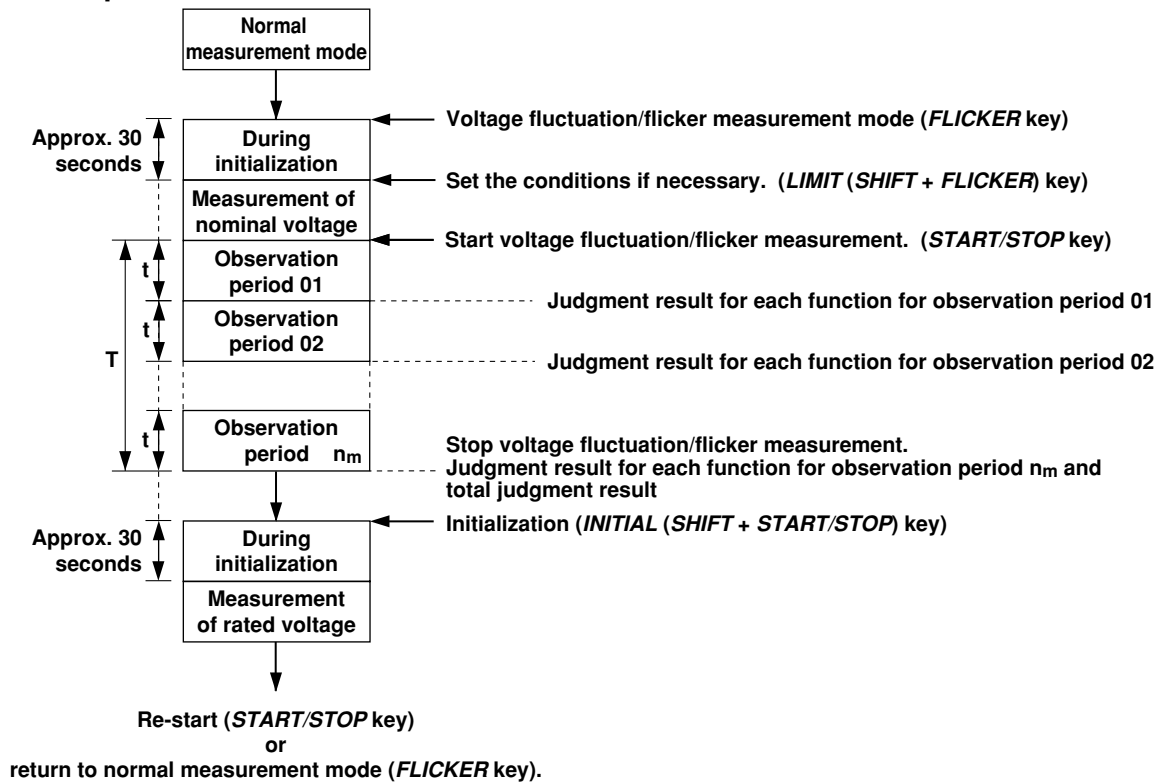

**To Improve Measurement Accuracy**

Before starting voltage fluctuation/flicker measurement, make sure the instrument has been warmed up for at least two hours. Also make the following settings.

- After elapse of more than 5 minutes following input of the supply voltage for measurement to the voltage input terminal, press the **INITIAL (SHIFT + START/STOP)** key.
- Set the crest factor to "3".
- Turn the line filter OFF.

**Note**

- When measuring the voltage fluctuation or flicker of an instrument with large rush current, set the cut-off frequency to 5.5 kHz and set the line filter to ON. For the setting method refer to Section 4.1 "Setting Measuring Conditions" (page 4-1).



## 10.2 Operating the Voltage Fluctuation/Flicker Measurement Functions (Optional)

To switch the instrument from normal measurement to voltage fluctuation/flicker measurement, you need to switch the measurement mode to voltage fluctuation/flicker measurement mode then sets the limits to be used for judgment and observation periods.

### Setting Voltage Fluctuation/Flicker Measurement Mode

#### Operating the **FLICKER** Key

Pressing the **FLICKER** key causes the FLICKER indicator LED to light up, indicating that the instrument is in fluctuation/flicker measurement mode.

To return from voltage fluctuation/flicker measurement mode to normal measurement mode, press the **FLICKER** key during initialization (i.e. while the **START/STOP** indicator LED is blinking). This will cause the FLICKER indicator LED to go out, indicating that the instrument is in normal measurement mode.

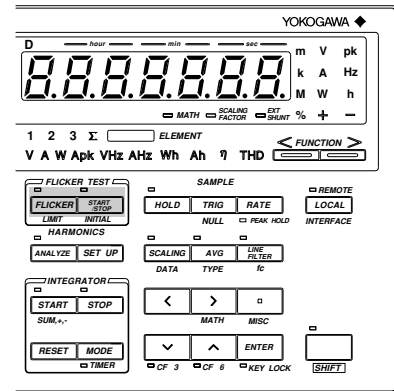

#### Operating the **START/STOP** Key

In fluctuation/flicker measurement mode, fluctuation/flicker measurement is started and stopped alternately each time the **START/STOP** key is pressed. The FLICKER indicator LED lights up when fluctuation/flicker measurement is started, and it goes out when fluctuation/flicker measurement is stopped.

Pressing the **INITIAL (SHIFT + START/STOP)** key while fluctuation/flicker measurement is stopped will cause the FLICKER indicator LED to blink and "E r r 13" to be displayed on display B, indicating that initialization is now under way.

When you want to re-start fluctuation/flicker measurement after it has been stopped, always carry out initialization.

| <b>START/STOP LED</b> | <b>State</b>   | <b>START/STOP key</b> | <b>INITIAL (SHIFT+START/STOP) key</b> |
|-----------------------|----------------|-----------------------|---------------------------------------|
| Blinking              | Initialization | ○ Start               | ○ Initialization                      |
| Continuously lit      | Start          | ○ Stop                | × (Err25)                             |
| Not lit               | Stop           | × (Err22)             | ○ Initialization                      |

#### Note

- Switching to fluctuation/flicker measurement mode while integration is in progress (START indicator LED is lit) or while integration is stopped (STOP indicator LED is lit) is not allowed. If such an attempt is made, "E r r 13" will occur. To switch fluctuation/flicker measurement mode in such cases, stop integration, press the **RESET** key, then press the **FLICKER** key.
- Starting integration during fluctuation/flicker measurement mode is not allowed. If such an attempt is made, "E r r 20" will occur.
- Switching to voltage fluctuation/flicker measurement mode while harmonic analysis is in progress is not allowed. If such an attempt is made, "E r r 15" will occur. To switch to fluctuation/flicker measurement mode in such cases, press the **ANALYZE** key to return to normal measurement mode, then press the **FLICKER** key.
- Switching to harmonic analysis mode while voltage fluctuation/flicker measurement is in progress is not allowed. If such an attempt is made, "E r r 20" will occur. To switch to harmonic analysis mode in such cases, press the **FLICKER** key to return to normal measurement mode, then press the **ANALYZE** key.

### Display Update Cycle

The display update cycle during fluctuation/flicker measurement mode is fixed at 2 seconds.

## 10.3 Setting Measuring Conditions (Optional)

For fluctuation/flicker measurement, measuring conditions must be set prior to start of measurement. Relative voltage change in relation to the rated voltage measured under fluctuation is measured. Moreover, short-term flicker value is measured and calculated for each observation period.

### Setting the Nominal Voltage

Set the nominal voltage which is used as the reference for relative voltage change. Select "M V t □" if you want to set the nominal voltage by measuring it, or select "S E t" if you want to use the existing value as the nominal voltage.

1. Press the **LIMIT (SHIFT + FLICKER)** key.

Press the  $\wedge$  or  $\vee$  key until "M V t" is displayed on display D.

2. Press the **ENTER** key.

3. The symbol displayed on display B will change in the following order, so select the desired symbol.

M V t □ (measured value) → S E t (existing value) → M V t □

4. Press the **ENTER** key.

If "S E t" is selected in step 3, proceed to step 5.

5. The currently selected existing nominal value is displayed on display C, with the digit on the extreme left blinking. You can change the value at the blinking digit. Pressing the  $\wedge$  key changes the value in the order 1, 2, 3, ... 9, 0 and back to 1. Pressing the  $\vee$  key changes the value in the opposite direction. The blinking position can be shifted to the left or right by pressing the  $\lt$  or  $\gt$  key respectively. The existing nominal voltage can be set within the following range.

Settable range : 0.01 to 999.99 (V)

Default : 230.00 (V)

After the desired value has been set, press the **ENTER** key.

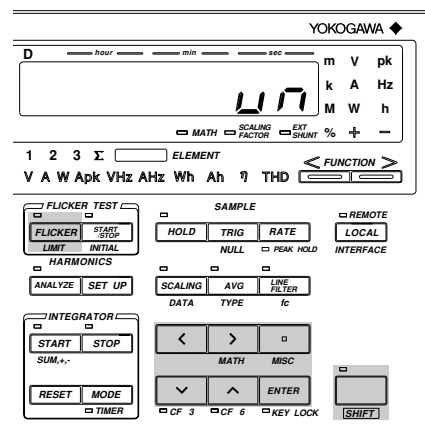

Display

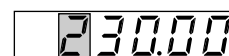

Press the  $\gt$  key.



Display

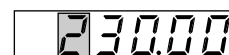

Press the  $\wedge$  key.

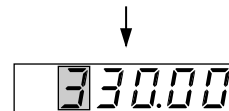

### Setting the Limit for Relative Steady-state Voltage Change

1. Press the **LIMIT (SHIFT + FLICKER)** key.  
Press the  $\wedge$  or  $\vee$  key until "d c" is displayed on display D.
2. Press the **ENTER** key.
3. Determine whether or not relative steady-state voltage change is to be judged.  
The symbol displayed on display B will change in the following order, so select the desired symbol.  
 $\square \pi$  (judged)  $\rightarrow$   $\square F F$  (not judged)  $\rightarrow$   $\square \pi$
4. Press the **ENTER** key.  
If " $\square \pi$ " is selected in step 3, proceed to step 5.
5. The currently selected limit for relative steady-state voltage change is displayed on display C, with the digit on the extreme left blinking. You can change the value at the blinking digit. Pressing the  $\wedge$  key changes the value in the order 1, 2, 3, ... 9, 0 and back to 1. Pressing the  $\vee$  key changes the value in the opposite direction. The blinking position can be shifted to the left or right by pressing the  $<$  or  $>$  key respectively.  
The limit can be set within the following range.  
 Settable range : 1.00 to 99.99 (%)  
 Default : 3.00 (%)  
 After the desired limit has been set, press the **ENTER** key.

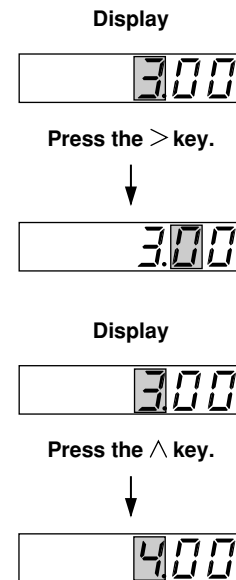
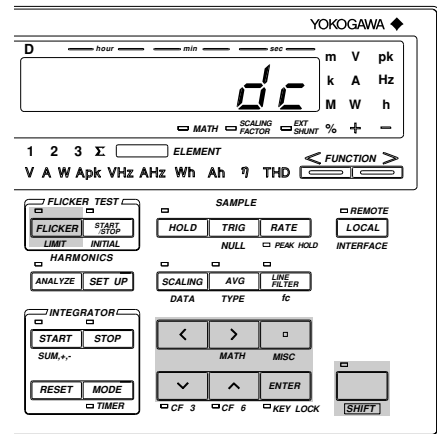

Setting the Limit for Maximum Relative Voltage Change

1. Press the **LIMIT** (**SHIFT** + **FLICKER**) key.  
Press the  $\wedge$  or  $\vee$  key until "d n R!!" is displayed on display D.
2. Press the **ENTER** key.
3. Determine whether or not maximum relative voltage change is to be judged.  
The symbol displayed on display B will change in the following order, so select the desired symbol.  
□ n (judged) → □ F F (not judged) → □ n
4. Press the **ENTER** key.  
If "□ n" is selected in step 3, proceed to step 5.

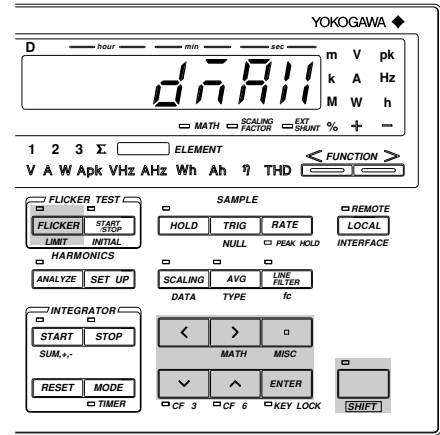

5. The currently selected limit for maximum relative voltage change is displayed on display C, with the digit on the extreme left blinking. You can change the value at the blinking digit. Pressing the  $\wedge$  key changes the value in the order 1, 2, 3, ... 9, 0 and back to 1. Pressing the  $\vee$  key changes the value in the opposite direction. The blinking position can be shifted to the left or right by pressing the  $<$  or  $>$  key respectively.

The limit can be set within the following range.

Settable range : 1.00 to 99.99 (%)  
Default : 4.00 (%)

After the desired limit has been set, press the **ENTER** key.

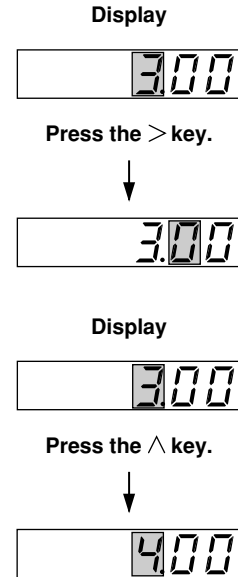

### Setting the Limit for Period during which Relative Voltage Change Exceeds the Threshold Level during a Voltage Change and Setting the Threshold Level

1. Press the **LIMIT (SHIFT + FLICKER)** key.  
Press the  $\wedge$  or  $\vee$  key until "dL" is displayed on display D.

2. Press the **ENTER** key.

3. Determine whether or not the period during which relative voltage change is above the threshold level is to be judged.  
The symbol displayed on display B will change in the following order, so select the desired symbol.

$\square \pi$  (judged)  $\rightarrow$   $\square F F$  (not judged)  $\rightarrow$   $\square \pi$

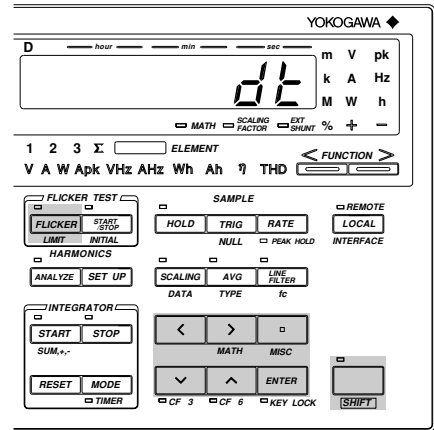

4. Press the **ENTER** key.  
If " $\square \pi$ " is selected in step 3, proceed to step 5.

5. The currently selected limit for the period during which relative voltage change is above the threshold level is displayed on display C, with the digit on the extreme left blinking. You can change the value at the blinking digit. Pressing the  $\wedge$  key changes the value in the order 1, 2, 3, ... 9, 0 and back to 1. Pressing the  $\vee$  key changes the value in the opposite direction. The blinking position can be shifted to the left or right by pressing the  $<$  or  $>$  key respectively.

The limit can be set within the following range.

Settable range : 1 to 99999 (ms)

Default : 200 (ms)

After the desired limit has been set, press the **ENTER** key.

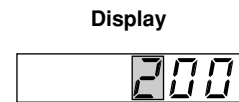

Press the  $>$  key.

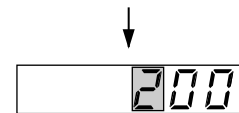

Display



Press the  $\wedge$  key.

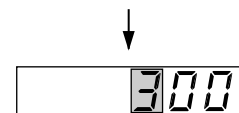

6. The currently selected threshold level is displayed on display D, with the digit on the extreme left blinking. You can set the desired threshold level in the same method as step 5.

The threshold level can be set within the following range.

Settable range : 1.00 to 99.99 (%)

Default : 3.00 (%)

After the desired threshold level has been set, press the **ENTER** key.

### Setting the Limit for Short-term Flicker Value

1. Press the **LIMIT (SHIFT + FLICKER)** key.  
Press the  $\wedge$  or  $\vee$  key until "P5t" is displayed on display D.
2. Press the **ENTER** key.
3. Determine whether or not short-term flicker value is to be judged.  
The symbol displayed on display B will change in the following order, so select the desired symbol.  
□n (judged) → □FF (not judged) → □n
4. Press the **ENTER** key.  
If "□n" is selected in step 3, proceed to step 5.

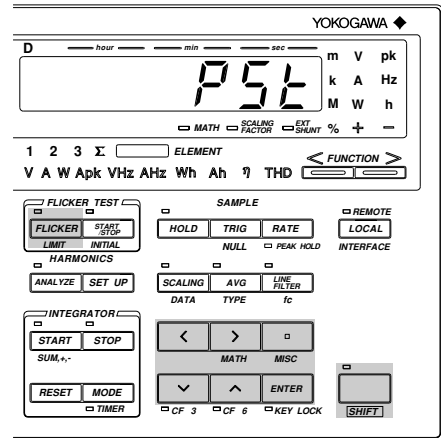

5. The currently selected short-term flicker value is displayed on display C, with the digit on the extreme left blinking. You can change the value at the blinking digit. Pressing the  $\wedge$  key changes the value in the order 1, 2, 3, ... 9, 0 and back to 1. Pressing the  $\vee$  key changes the value in the opposite direction. The blinking position can be shifted to the left or right by pressing the  $<$  or  $>$  key respectively. The short-term flicker value can be set within the following range.  
Settable range : 0.10 to 99.99  
Default : 1.00  
After the desired value has been set, press the **ENTER** key.

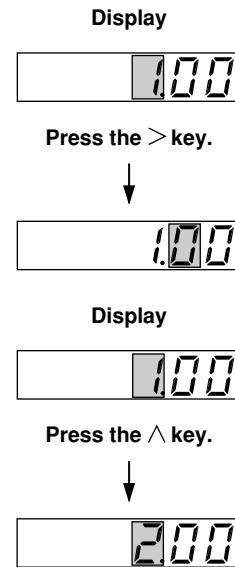

Setting the Limit for Long-term Flicker Value and the Constant used in the Equation

1. Press the **LIMIT (SHIFT + FLICKER)** key.  
Press the  $\wedge$  or  $\vee$  key until "P L t" is displayed on display D.

2. Press the **ENTER** key.

3. Determine whether or not long-term flicker value is to be judged.  
The symbol displayed on display B will change in the following order, so select the desired symbol.

$\square \pi$  (judged)  $\rightarrow$   $\square F F$  (not judged)  $\rightarrow$   $\square \pi$

4. Press the **ENTER** key.  
If " $\square \pi$ " is selected in step 3, proceed to step 5.

5. The currently selected long-term flicker value is displayed on display C, with the digit on the extreme left blinking. You can change the value at the blinking digit. Pressing the  $\wedge$  key changes the value in the order 1, 2, 3, ... 9, 0 and back to 1. Pressing the  $\vee$  key changes the value in the opposite direction. The blinking position can be shifted to the left or right by pressing the  $<$  or  $>$  key respectively. The long-term flicker value can be set within the following range.  
Settable range : 0.10 to 99.99  
Default : 0.65  
After the desired value has been set, press the **ENTER** key.

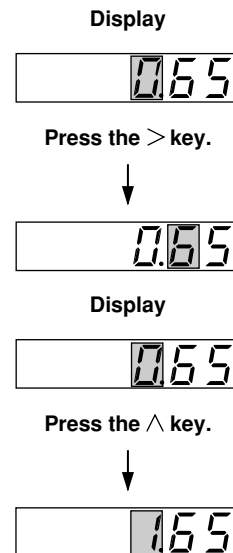
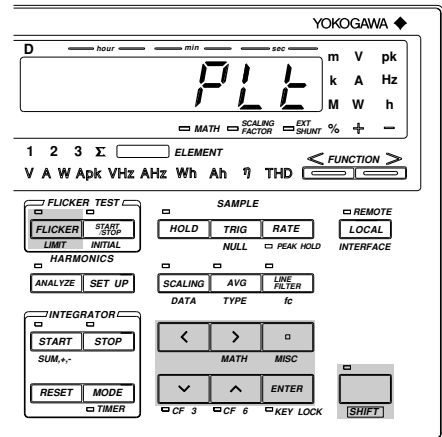

6. The currently selected constant used in the equation is displayed on display D, with the digit on the extreme left blinking. You can set the desired constant in the same method as step 5.  
The constant can be set within the following range.  
Settable range : 1 to 99  
Default : 12  
After the desired constant has been set, press the **ENTER** key.

**Note**

- The equation used to calculate the long-term flicker value is shown below.

$$Plt = \sqrt[3]{\sum_{i=1}^{nm} Psti^3 \cdot N}$$

"nm" in the equation indicates the number of times measurement of short-term flicker value (Pst) is to be performed (see page 10-11).

The constant used in the equation is "N". If this constant is greater than the number of times measurement of short-term flicker value is to be performed, measurement of short-term flicker value will be performed the specified number of times, and non-measured short-term flicker value will be calculated as "Pst = 0".

This function is used in cases where the object to be measured stops automatically within the specified measurement time. In general, set the constant to the same value as the number of times measurement of short-term flicker value is to be performed

### Setting the Observation Period for Short-term Flicker Value

1. Press the **LIMIT** (**SHIFT** + **FLICKER**) key.  
Press the  $\wedge$  or  $\vee$  key until "1 n t H A L L" is displayed on display D.

2. Press the **ENTER** key.

3. The currently selected observation period for short-term flicker value is displayed on display D, with the digit on the extreme left blinking. You can change the value at the blinking digit. Pressing the  $\wedge$  key changes the value in the order 1, 2, 3, ... 9, 0 and back to 1. Pressing the  $\vee$  key changes the value in the opposite direction. However, seconds can be set only in even values. The blinking position can be shifted to the left or right by pressing the  $<$  or  $>$  key respectively.

The number of times can be set within the following range.

Settable range : 0 min 30 s to 15 min 00 s

Default : 10 min 00 s

After the desired observation period has been set, press the **ENTER** key.

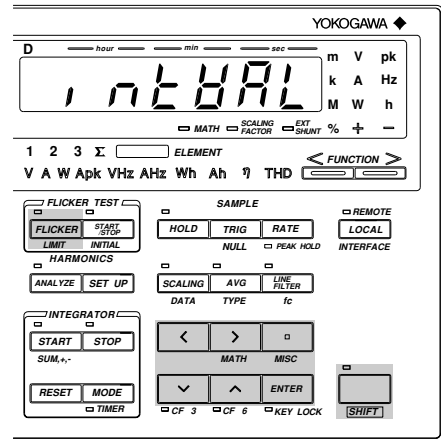

Display



Press the  $>$  key.



Display



Press the  $\wedge$  key.





### Setting the Number of Times Measurement of Short-term Flicker Value is to be Performed

1. Press the **LIMIT (SHIFT + FLICKER)** key.  
Press the  $\wedge$  or  $\vee$  key until "Count" is displayed on display D.

2. Press the **ENTER** key.

3. The currently selected number of times measurement of short-term flicker value is to be performed is displayed on display D, with the digit on the extreme left blinking. You can change the value at the blinking digit. Pressing the  $\wedge$  key changes the value in the order 1, 2, 3, ... 9, 0 and back to 1. Pressing the  $\vee$  key changes the value in the opposite direction. The blinking position can be shifted to the left or right by pressing the  $<$  or  $>$  key respectively. The number of times can be set within the following range.

Settable range : 1 to 99

Default : 12

After the desired value has been set, press the **ENTER** key.



Display



Press the  $>$  key.



Display



Press the  $\wedge$  key.



#### Note

- Measurement time for short-term flicker value is given below.  
Observation period for short-term flicker value x Number of times measurement of short-term flicker value is to be performed

### Setting the Steady-state Range

Set the allowable range for steady-state relative voltage change.

1. Press the **LIMIT** (**SHIFT** + **FLICKER**) key.  
Press the  $\wedge$  or  $\vee$  key until "d n n" is displayed on display D.

2. Press the **ENTER** key.

3. The currently selected allowable range is displayed on display C, with the digit on the extreme left blinking. You can change the value at the blinking digit. Pressing the  $\wedge$  key changes the value in the order 1, 2, 3, ... 9, 0 and back to 1. Pressing the  $\vee$  key changes the value in the opposite direction. The blinking position can be shifted to the left or right by pressing the  $<$  or  $>$  key respectively.

The allowable range can be set within the following range.

Settable range : 0.10 to 9.99 (%)

Default : 0.10 (%)

After the desired range has been set, press the **ENTER** key.

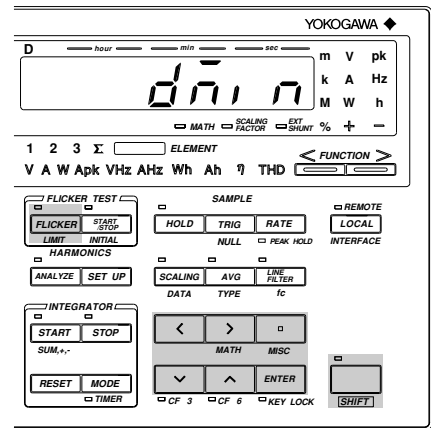

Display



Press the  $>$  key.

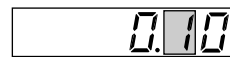

Display



Press the  $\wedge$  key.



### Selecting the Element for which Voltage Fluctuation/Flicker Measurement is Performed

Set whether or not voltage fluctuation/flicker measurement is to be carried out for each element.

1. Press the **LIMIT (SHIFT + FLICKER)** key.  
Press the  $\wedge$  or  $\vee$  key until "E L E n" is displayed on display D.
2. Press the **ENTER** key.
3. "n" blinks on display B, and "F F" displayed steadily on both displays C and D.  
Input elements correspond to displays B to D as follows.

- Display B : Element 1
- Display C : Element 2
- (available only for the 253103)
- Display D : Element 3

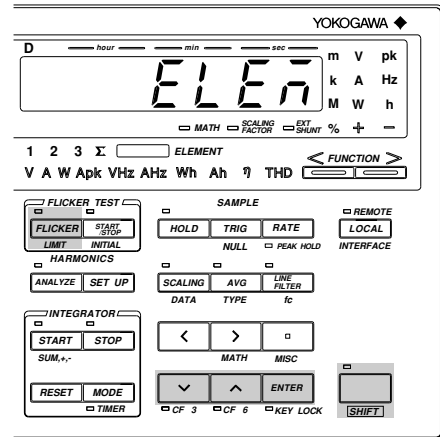

So, set whether or not measurement is to be carried out for elements one by one, starting with element 1 (display B).

Press the  $\wedge$  or  $\vee$  key to select "n" if you want measurement to be performed, or select "F F" if not. Then, press the **ENTER** key.

When setting is made for element 1 (display B), "n" (or "F F") will blink on display C, so make setting for element 2 in the same way. Make sure that setting is made for all elements 1 to 3.

## 10.4 Displaying the Voltage Fluctuation and Flicker Values (Optional)

### Initializing Voltage Fluctuation/Flicker Measurement and Measuring Nominal Voltage

Press the **FLICKER** key. Voltage fluctuation/flicker measurement mode will be activated and initialization is performed. "U, n, t" is displayed on display B during initialization. Measurement of nominal voltage (Un) is also performed during initialization.

The nominal voltage value will be displayed C and nominal voltage frequency on display D. They will be updated every 2 seconds.

To select the element for which nominal voltage is to be measured, press the **ELEMENT** key located on displays A, B, C or D. Any of these **ELEMENT** keys can be used to select the desired element.

#### Note

- Initialization is performed immediately after the measurement mode is switched from normal measurement to voltage fluctuation/flicker measurement mode. Thus, make sure that wiring of the instrument is complete and supply voltage for measurement is input to the terminal of the instrument before switching to voltage fluctuation/flicker measurement mode.  
If supply voltage for measurement is input to the terminal of the instrument after the mode has been switched to voltage fluctuation/flicker measurement mode, press the **INITIAL (SHIFT + START/STOP)** key to perform initialization. During initialization, make sure the supply voltage for measurement is constant.
- The following operations can be performed during measurement of rated voltage.
  - Changing the measuring range (however, no current is displayed) → Initialization is performed.
  - Changing the crest factor → Initialization is performed.
  - Turning the scaling function ON or OFF
  - Turning the line filter ON or OFF → Initialization is performed.
  - Changing the cut-off frequency for the line filter → Initialization is performed.
  - Starting voltage fluctuation measurement using the **START/STOP** key (voltage fluctuation/flicker measurement)

### Setting the Function for Voltage Fluctuation Measurement

When performing voltage fluctuation measurement, use the **FUNCTION** and **ELEMENT** keys located below display A to set the measured data to be displayed.

#### Operating the FUNCTION Key

Press the **FUNCTION** key below display A to set the function to be displayed during voltage fluctuation measurement.. The function is switched in the following order each time the **FUNCTION** key is pressed.

U n (nominal voltage) → d c (relative steady-state voltage change) → d n H I (maximum relative voltage change) → d t (total period during which voltage change is above the threshold level) → P S t (short-term flicker value) → P L t (long-term flicker value) → t c H L (total judgment result) → U n → . . . .

#### Operating the ELEMENT Key

Press the **ELEMENT** key located below displays A, B, C or D to select the desired element. Any of these **ELEMENT** keys can be used. However, it is not possible to select  $\Sigma$  for element.

### Starting Voltage Fluctuation/Flicker Measurement

Press the **START/STOP** key.

For a detailed description, refer to Section 10.2 "Operating the Voltage Fluctuation/Flicker Measurement Functions".

### Data Displayed during Measurement

During voltage fluctuation/flicker measurement, the following data is displayed as follows when the **FUNCTION** key located below display A is pressed.

| Display A                         | Display B | Display C                 | Display D               |
|-----------------------------------|-----------|---------------------------|-------------------------|
| $u_n$                             | None      | Nominal voltage           | Input voltage frequency |
| $d_c$ and observation period      | Limit     | Maximum value (up to now) | Elapsed time            |
| $d_{nR11}$ and observation period | Limit     | Maximum value (up to now) | Elapsed time            |
| $d_t$ and observation period      | Limit     | Maximum value (up to now) | Elapsed time            |
| $P_{St}$ and observation period   | Limit     | ---- (no data)            | Elapsed time            |
| $P_{Lt}$                          | Limit     | ---- (no data)            | Elapsed time            |
| $t_{oFR}$                         | None      | ---- (no data)            | Elapsed time            |

Maximum values which can be displayed during measurement are shown below.

$d_c$  : 999.99%

$d_{nR11}$  : 999.99%

$d_t$  : 99999 ms

$P_{St}$  : 999.99

$P_{Lt}$  : 999.99

" - -  $F$  - - " will be displayed if these maximum values are exceeded.

#### Note

- " $P_{St}$ " and " $P_{Lt}$ " are not displayed until measurement is complete.
- " $t_{oFR}$ " is not displayed until judgment is complete.
- If instantaneous flicker value exceeds 6400 level during an observation period, "- -  $F$  - -" will be displayed as the short-term flicker value ( $P_{St}$ ) measured during that observation period and " $F_{R, L}$ " displayed as the judgment result for the short-term flicker value.

### Setting the Observation Period

The observation period set for short-term flicker value is considered as one observation period, and the first observation period is displayed as " $d_t$ ".

To increase the observation period for " $d_c$ ", " $d_{nR11}$ ", " $d_t$ " and " $P_{St}$ ", press the  $\wedge$  key. To decrease it, press the  $\vee$  key.

The elapsed time of observation period which finished a measurement will be displayed in the judgment result.

### Selecting the Element to be Displayed

Press the **ELEMENT** key located below displays A, B, C or D to select the desired element. All the data relating to the selected element will be switched at the same time when the **ELEMENT** key is pressed.

#### Note

- If the **INITIAL** (**SHIFT** + **START/STOP**) key is pressed during display of judgment result, initialization will be performed and measurement of nominal voltage is started.

### Stopping Voltage Fluctuation/Flicker Measurement

When measurement of short-term flicker value (Pst) has been performed the number of times specified in 10.3 "Setting Measuring Conditions, voltage fluctuation/flicker measurement will be stopped, and the judgment result is displayed. The START/STOP indicator LED will also go out. If the **START/STOP** key is pressed during voltage fluctuation/flicker measurement, the data measured up to the depression of the **START/STOP** key will be used to make judgment, and the judgment result is then displayed.

## 10.5 Displaying the Judgment Result (Optional)

The judgment result is displayed for the observation periods for which measurement has been completed or it is displayed when voltage fluctuation/flicker measurement is stopped.

The judgment result for each function is displayed as follows when the **FUNCTION** key located below display A is pressed.

| Display A                       | Display B | Display C                                     | Display D               |
|---------------------------------|-----------|---|-------------------------|
| u n                             | None      | Nominal voltage                               | Input voltage frequency |
| d c and observation period      | Limit     | Maximum value (within the observation period) | Judgment result*1,*2    |
| d n R !! and observation period | Limit     | Maximum value (within the observation period) | Judgment result*1       |
| d t and observation period      | Limit     | Maximum value (within the observation period) | Judgment result*1       |
| P S t and observation period    | Limit     | Calculation result                            | Judgment result*1       |
| P L t                           | Limit     | Calculation result                            | Judgment result*1       |
| t o t R L                       | None      | Total judgment result*3                       | Elapsed time            |

\*1 For judgment result, "P R S S" will be displayed if no voltage change has exceeded the specified limit, otherwise "F R ! L" will be displayed. For items which have been set to be not judged (i.e. "o F F"), " \_ \_ \_ \_ " will be displayed.

\*2 If the display of display C of "d c" is "u n d E F" (refer to next page), "E r r o r" is displayed.

\*3 If all the items which have been set to be judged are "P R S S", the total judgment result will be "P R S S".

### Displaying the Observation Period

To increase the observation period for "d c", "d n R !!", "d t" and "P S t", press the  $\wedge$  key. To decrease it, press the  $\vee$  key.

### Changing the Element to be Displayed

Pressing the **ELEMENT** key located below displays A, B, C or D to switch the currently selected element to another. All the data relating to the selected element will be switched at the same time as the **ELEMENT** key is pressed.

#### Note

- If the **INITIAL** (**SHIFT** + **START/STOP**) key is pressed during display of judgment result, initialization will be performed and measurement of nominal voltage is started.

# 10.6 Points to Note during Use of the Voltage Fluctuation/Flicker Measurement Function (Optional)

## Limits Specified in IEC1000-3-3

IEC1000-3-3 (Limitation of voltage fluctuations and flicker for instruments with phase input current of 16 A or below) specifies the limits as follows.

|  |              |                 |
|--|--------------|-----------------|
| Relative steady-state voltage change                           | dc           | 3% or less      |
| Maximum relative voltage change                                | dmax         | 4% or less      |
| Total duration during which relative voltage change exceeds 3% | d (t) 200 ms | 200 ms or below |
| Short-term flicker value                                       | Pst          | 1.00 or less    |
| Long-term flicker value  | Plt          | 0.65 or less    |
| Observation period   | 10 minutes   |                 |
| Number of times measurement is performed                       | 12           |                 |
| Constant used in the equation                                  | 12           |                 |

## Relative Steady-state Voltage Change (dc)

In IEC1000-3-3, relative steady-state voltage change (dc) is defined with assumption that steady-state exists more than twice.

This instrument assumes that a steady-state has existed once before measurement is started, and displays the measured relative steady-state voltage change (dc) if voltage fluctuation occurs more than once and then a steady-state continues for more than one second after the **START/STOP** key is pressed to start measurement. If no steady-state spanning more than one second exists, "UNDEF" will be displayed on display C until such steady-state occurs. If no voltage fluctuation occurs after measurement is started, "0" will be displayed as dc.

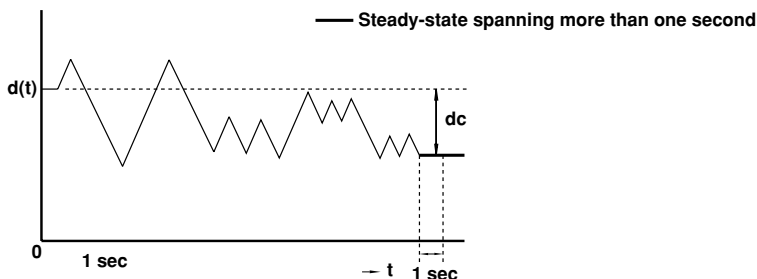

"UNDEF" is displayed on display B until such steady-state occurs. If a steady-state spanning more than one second occurs, the measured value will be displayed.

## Display of dc, dmax and d (t) 200ms

dc, dmax and maximum d (t) 200ms within each observation period are displayed.

### Example of dc

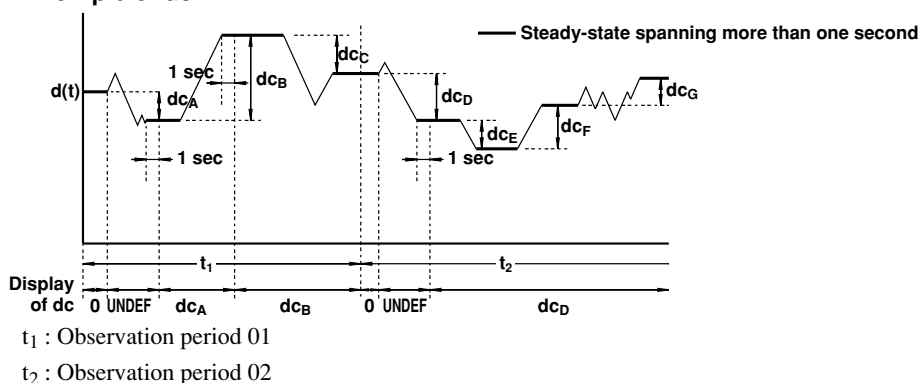

## 10.6 Points to Note during Use of the Voltage Fluctuation/Flicker Measurement Function (Optional)

### Operating the Front Panel Keys during Voltage Fluctuation/Flicker Measurement Mode

During voltage fluctuation/flicker measurement mode, some front panel keys are disabled for functions which cannot be used or have no effect. A detailed description for such limitations is given below.

| Function             | Key                                     | INITIAL<br>LED: Blinking | START<br>LED: Lit Steadily | STOP<br>LED: Not Lit |
|----------------------|---|--------------------------|----------------------------|----------------------|
| Flicker              | <b>FLICKER</b>                          | ○                        | ×                          | ×                    |
|                      | <b>LIMIT (SHIFT + FLICKER)</b>          | ○ (Setting possible)     | △                          | △                    |
|                      | <b>START/STOP</b>                       | ○                        | ○                          | ×                    |
|                      | <b>INITIAL (SHIFT + START/STOP)</b>     | ○                        | ×                          | ○                    |
| Wiring System        | <b>WIRING</b>                           | ○                        | ○                          | ○                    |
| Range                | <b>VOLTAGE AUTO, &lt;, &gt;</b>         | ○ (×AUTO)                | ×                          | ×                    |
|                      | <b>CURRENT AUTO, &lt;, &gt;</b>         | ○ (×AUTO)                | ×                          | ×                    |
| Measurement Mode     | <b>RMS/MAIN/DC</b>                      | V: ×<br>A: ×             | V: ×<br>A: ×               | V: ×<br>A: ×         |
| Sampling             | <b>HOLD</b>                             | ×                        | ×                          | ×                    |
|                      | <b>TRIG</b>                             | —                        | —                          | —                    |
|                      | <b>RATE</b>                             | Fixed at 2 seconds       | Fixed at 2 seconds         | Fixed at 2 seconds   |
| NULL Function        | <b>NULL (SHIFT+TRIG)</b>                | ×                        | ×                          | ×                    |
|                      | <b>PEAK HOLD (SHIFT+RATE)</b>           | ×                        | ×                          | ×                    |
| Line Filter          | <b>LINE FILTER</b>                      | ○                        | ×                          | ×                    |
| Cut-off Frequency    | <b>fc (SHIFT+LINE FILTER)</b>           | ○                        | △                          | △                    |
| Averaging            | <b>AVG</b>                              | ×                        | ×                          | ×                    |
| Scaling              | <b>SCALING</b>                          | ○                        | ×                          | ×                    |
| Crest Factor         | <b>CF3 (SHIFT + ∨)</b>                  | ○                        | ×                          | ×                    |
|                      | <b>CF6 (SHIFT + ∧)</b>                  |                          |                            |                      |
| Harmonic Analysis    | <b>ANALYZE</b>                          | ×                        | ×                          | ×                    |
|                      | <b>SET UP</b>                           | ○                        | ○                          | ○                    |
| Computation Function | <b>START</b>                            | ×                        | ×                          | ×                    |
|                      | <b>STOP</b>                             | ×                        | ×                          | ×                    |
|                      | <b>RESET</b>                            | ×                        | ×                          | ×                    |
|                      | <b>MODE</b>                             | ○                        | ○                          | ○                    |
| Frequency Filter     | <b>F-Filt (SHIFT+ □ (MISC)+ ∨ or ∧)</b> | ○                        | ○                          | ○                    |

× : Key operation is not possible.

○ : Key operation is possible.

△ : Confirmation only is possible

Pressing a key which cannot be used will display "Err 22", "Err 24", "Err 25" or "Err 26" on display D.



## 11.1 Loading a Roll Chart (Optional)

1. Press the left upper corner of the printer cover to open the cover.

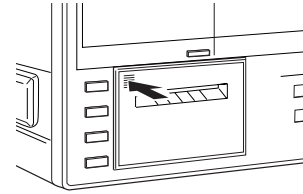

2. Lift the paper feed guide lever in the direction shown by the arrow to release the paper lock.

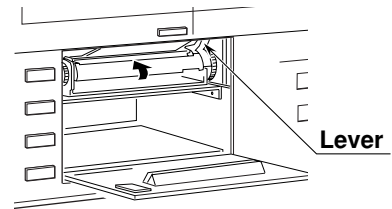

3. Insert the paper underneath the paper feed guide. Make sure that the paper is not skewed. Press the **FEED** key to feed the paper. (Make sure that the paper is fed in the direction as illustrated. If the paper is fed in the opposite direction, printing cannot be performed.)

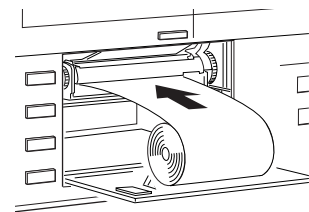

4. Hold down the **FEED** key until approximately 10 cm of the paper comes out of the top of the guide.

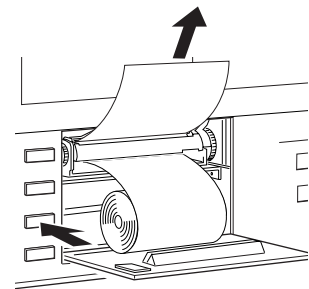

5. Push the middle of the guide in the direction shown by the arrow to secure the paper.

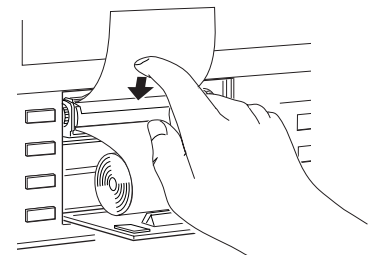

6. Place the paper inside the printer and pass the end of the paper through the slot in the printer cover.

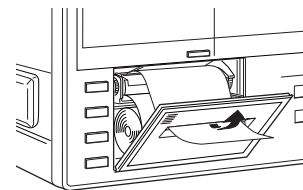

7. Close the printer cover.  
To cut the paper, just pull it upwards. If the printer cover is opened immediately after the paper is cut, press the **FEED** key to feed the paper until the end of the paper comes out through the slot in the printer cover.

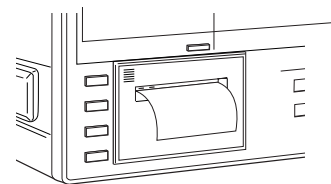

### Note

- Never press the **FEED** key if the PAPER ERROR LED is lit, except when loading a roll chart into the printer, otherwise a breakdown may result.

## 11.2 Setting Printer Output Functions (Optional)

The setting method of the printer output functions differs from that of the communications output functions. For the setting method of the communications output functions, refer to Section 14, "Using the Communications Functions". For print examples, refer to Appendix 3, "Print Examples".

### Selecting the Output Function Setting Menu

1. Press the **SET UP** key (**SHIFT + AUTO**).  
"P r, n t" will be displayed on display A.  
A. Press the  $\wedge$  or  $\vee$  key until "t E n" is displayed on display B.

2. Press the **ENTER** key.

### Selecting Output Function

3. Press the  $\wedge$  or  $\vee$  key to select the desired output function.

n o r : Used to select output items for normal measurement.

H A r : Used to select output items for harmonic analysis (optional).

F L, E : Used to select output items for flicker measurement (optional).

4. Press the **ENTER** key.

### Selecting Output Format

5. Press the  $\wedge$  or  $\vee$  key to select the desired output format.

Five output formats are available.

d F L t - 1 : Default output items are selected. (Refer to this page and next pages.)

d F L t - 2 : Default output items are selected. (Refer to next pages.)

A L L : All the output items which can be set with the instrument are selected.

S E L : Desired output items can be selected manually.

t L E A r : No output items are selected.

6. Press the **ENTER** key.

### Output Items when "n o r" is Selected as the Output Function and "d F L t - 1" is Selected on Display C:

- The numbers in the table below indicate the element No.

|    |      |    |                   |                    |
|----|------|----|-------------------|--------------------|
| V1 | V2*2 | V3 | V4 ( $\Sigma$ )*1 | Voltage            |
| A1 | A2*2 | A3 | A4 ( $\Sigma$ )*1 | Current            |
| W1 | W2*2 | W3 | W4 ( $\Sigma$ )*1 | Active power       |
| Hz |      |    |                   | Measured frequency |

\*1 : If the 1 $\Phi$ 2W (single-phase, two-wire) wiring method has been selected, no data will be output, and "-----" will be displayed.

\*2 : No data will be output for the three-phase, three-wire model (253102).

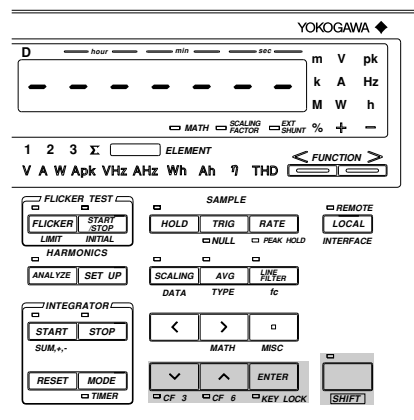
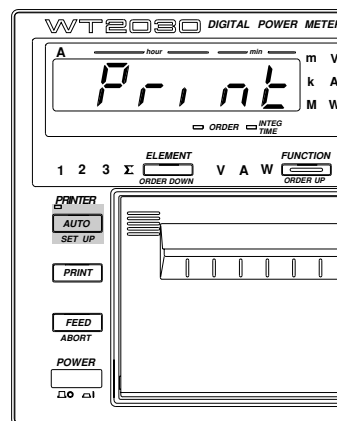

**Output Items when "n o r" is Selected as the Output Function and "d f l t - 2" is Selected on Display C:**

- The numbers in the table below indicate the element No.

|      |        |      |            |                             |
|------|--------|------|------------|-----------------------------|
| W1   | W2*2   | W3   | W4 (Σ)*1   | Active power                |
| Wh1  | Wh2*2  | Wh3  | Wh4 (Σ)*1  | Watt-hour                   |
| Wh+1 | Wh+2*2 | Wh+3 | Wh+4 (Σ)*1 | Positive watt-hour          |
| Wh-1 | Wh-2*2 | Wh-3 | Wh-4 (Σ)*1 | Negative watt-hour          |
| Ah1  | Ah2    | Ah3  | Ah4 (Σ)*1  | Ampere-hour                 |
| Ah+1 | Ah+2*2 | Ah+3 | Ah+4 (Σ)*1 | Positive ampere-hour        |
| Ah-1 | Ah-2*2 | Ah-3 | Ah-4 (Σ)*1 | Negative ampere-hour        |
| Hz   |        |      |            | Measured frequency          |
| HM   |        |      |            | Elapsed time of integration |

\*1 : If the 1Φ2W (single-phase, two-wire) wiring method has been selected, no data will be output, and "—" will be displayed.

\*2 : No data will be output for the three-phase, three-wire model (253102).

**Output Items when "H R r" is Selected as the Output Function and "d f l t - 1" is Selected on Display C:**

- The numbers in the table below indicate the element No.

|       |         |       |  |
|-------|---------|-------|--|
| V1    | V2*1    | V3    | Total rms value of voltage and analysis value of each harmonic from 1st up to n <sup>2</sup> th      |
| A1    | A2*1    | A3    | Total rms value of current and analysis value of each harmonic from 1st up to n <sup>2</sup> th      |
| W1    | W2*1    | W3    | Total rms value of active power and analysis value of each harmonic from 1st up to n <sup>2</sup> th |
| VTHD1 | VTHD2*1 | VTHD3 | Harmonic distortion of voltage   |
| ATHD1 | ATHD2*1 | ATHD3 | Harmonic distortion of current   |
| VCON1 | VCON2*1 | VCON3 | Content of each harmonic (from 2nd up to n <sup>2</sup> th) of voltage                               |
| ACON1 | ACON2*1 | ACON3 | Content of each harmonic (from 2nd up to n <sup>2</sup> th) of current                               |
| WCON1 | WCON2*1 | WCON3 | Content of each harmonic (from 2nd up to n <sup>2</sup> th) of active power                          |
| Hz    |         |       | PLL source frequency   |

\*1 : No data will be output for the three-phase, three-wire model (253102).

\*2 : "n" is the upper limit of the harmonic order.

**Output Items when "H R r" is Selected as the Output Function and "d f l t - 2" is Selected on Display C:**

- The numbers in the table below indicate the element No.

|       |         |       |  |
|-------|---------|-------|--|
| DEG1  | DEG2*1  | DEG3  | Phase angle between fundamentals   |
| VDEG1 | VDEG2*1 | VDEG3 | Phase angle of voltage of each harmonic from 2nd to n <sup>2</sup> th in relation to voltage of the 1st harmonic |
| ADEG1 | ADEG2*1 | ADEG3 | Phase angle of voltage of each harmonic from 2nd to n <sup>2</sup> th in relation to current of the 1st harmonic |
| Hz    |         |       | PLL source frequency   |

\*1 : No data will be output for the three-phase, three-wire model (253102).

\*2 : "n" is the upper limit of the harmonic order.

**Output Items when "F L , [ L]" is Selected as the Output Function and "d f l t - 1" is Selected on Display C:**

|       |                                       |
|-------|---------------------------------------|
| CPF1  | Cumulative probability function graph |
| Judg1 | Flicker meter judgment result table   |

**Output Items when "F L , [ L]" is Selected as the Output Function and "d f l t - 2" is Selected on Display C:**

|       |                                     |
|-------|-------------------------------------|
| Judg1 | Flicker meter judgment result table |
|-------|-------------------------------------|

**Output Items when "SEL" is Selected on Display C:**

If "SEL" is selected, the output item setting mode is activated. An output item will be displayed on display C, and display D can be used to determine whether the item is to be output or not.

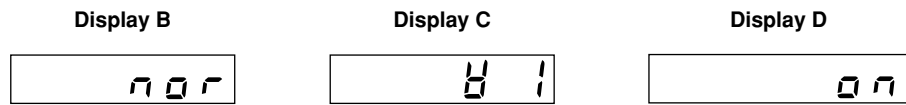

**Setting Output Items and Elements**

1. Press the ^ or v key to select the desired output item.

**Output Items which can be Selected: When "nor" is Selected as the Output Function**

|        |                               |                                 |
|--------|-------------------------------|---------------------------------|
| V      | A                             | W                               |
| VA     | var                           | PF                              |
| Frq    | Wh                            | WhP                             |
| WhM    | Ah                            | AhP                             |
| AhM    | deg                           | V peak                          |
| A peak | Efficiency, computation etc.) | t (Elapsed time of integration) |

**Output Items which can be Selected: When "HAr" is Selected as the Output Function**

|                          |                              |                              |
|--------------------------|------------------------------|------------------------------|
| V                        | A                            | W                            |
| deg                      | Graph of voltage             | Graph of current             |
| Graph of power           | Graph of voltage phase angle | Graph of current phase angle |
| Graph of voltage content |                              | Graph of current content     |
| Graph of power content   |                              |                              |

**Output Items which can be Selected: When "FL, L" is Selected as the Output Function**

- PF (Cumulative probability function graph)
- jud (Flicker meter judgment result table)

To select the desired element, press the < or > key.

**Elements Which can be Selected**

- 1 : Element 1
- 2 : Element 2 (Not available with the three-phase, three-wire model (253620))
- 3 : Element 3
- 4 : Element Σ (Cannot be selected if Vpeak or Apeak is selected when "HAr" or "FL, L" has been selected as the output function.)

It is not possible to select any element for efficiency/computation or elapsed time of integration.

**Note**

- If many output items are selected, it may take some time before the printer begins to print. In this case, reduce the number of output items or hold measurement.

2. Press the **ENTER** key.  
"  $\square$   $\pi$  " or "  $\square$   $F$   $F$  " on display D will begin to blink.
3. Press the  $\wedge$  or  $\vee$  key to select "  $\square$   $\pi$  " or "  $\square$   $F$   $F$  ".
4. Press the **ENTER** key.  
The digit on the extreme left on display C will begin to blink automatically, so set the desired output item (or element).
5. Repeat steps 1 to 4 until all the desired output items have been selected.
6. To exit in the middle of selection of output items, press the **AUTO (SET UP)** or **SHIFT** key.

---

**Note**

- The following frequency data will be output.  
During normal measurement : Frequency selected on display D or frequency of the function previously selected on display D  
During harmonic analysis : Frequency of PLL source
-

# 11.3 Printing a Set-up Information List

## Set-up Information which can be Printed

Set-up information which can be printed is given in Appendix 3.

The output format is the same as that used by the OS communications command, except that in the case of communications "END" is printed on the last line.

### Print Set-up

1. Press the **SET UP** key (**SHIFT + AUTO**.)  
Press the  $\wedge$  or  $\vee$  key until "Print" is displayed on display B.
2. Press the **ENTER** key to start printing.  
When printing is complete.  
Measurement will be resumed.

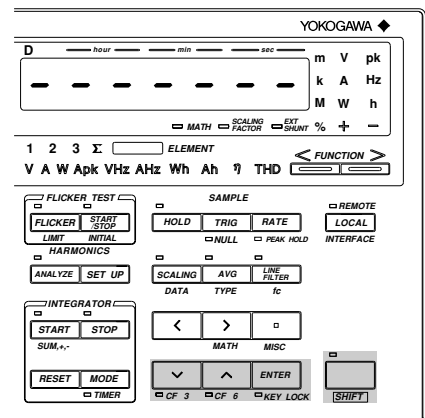
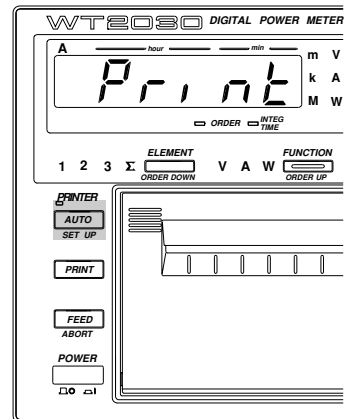

# 11.4 Printing Measured Values in Manual or Auto Print Mode (Optional)

## Keys used for Printing

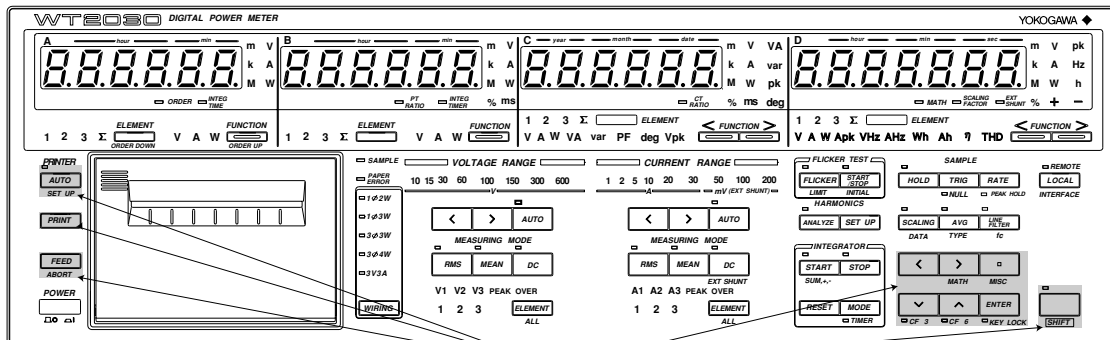

These keys are used.

## Printing Measured Values in Manual Print Mode

### Procedure

1. Press the **PRINT** key.  
The printer will begin to print out measured values.  
The **PRINT** key is also valid in auto print mode.

### Note

- If many output items are selected, it may take some time before the printer starts to print after the **PRINT** key is pressed.

#### Printing during flicker measurement (optional)

- Printing is not possible even if the **PRINT** key is pressed during measurement of rated voltage. "E r r 2 0" will occur.
- Printing is not possible even if the **PRINT** key is pressed during measurement of fluctuating voltage (if the time required for one measurement of short-term flicker value has not yet elapsed). "E r r 2 0" will occur.
- A cumulative probability function graph regarding the previous measurement time of short-term flicker value will be output if the **PRINT** key is pressed during measurement of fluctuating voltage (if the time required for one measurement of short-term flicker value has already elapsed).
- A cumulative probability function graph and flicker meter judgment result table regarding the previous measurement time of short-term flicker value will be output if the **PRINT** key is pressed during display of the judgment result (if the time calculated by multiplying the time required for each measurement of short-term flicker value by the number of times measurement is carried out has already elapsed).

**Printing Measured Values in Auto Print Mode**

In auto print mode, measured values are printed out automatically at the specified print intervals. They can be printed out in the following three modes.

- Timer synchronous print : Prints measured values according to the preset auto print start/stop time.
- Integration synchronous print : Prints measured values in synchronization with integration.
- Flicker synchronous print (optional) : Prints measured values at the specified short-term flicker intervals when flicker measurement (optional) is in progress.

Print timing charts for the **AUTO** key (during timer synchronous print mode) and for a preset start/stop time are given below.

**Print timing when print start time passes before depression of the *AUTO* key**

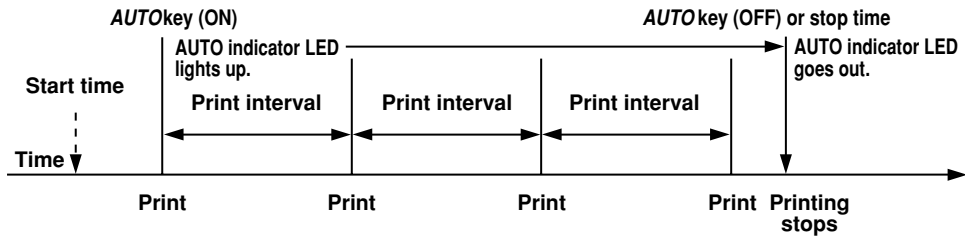

**Print timing when print start time passes after depression of the *AUTO* key**

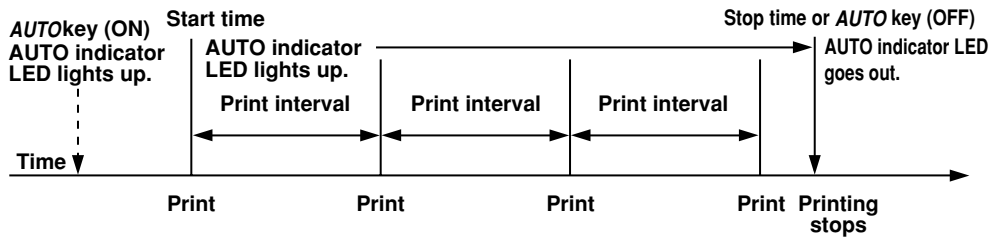

**Note**

- If the preset stop time has already passed when the **AUTO** key is turned ON, error code "E r r ! ?" will be displayed.

1. Press the **SET UP** key (**SHIFT + AUTO**).  
"P r , n t" will be displayed on display A. Press the  $\wedge$  or  $\vee$  key until "S t A r t" is displayed on display B.
2. Press the **ENTER** key.

**Setting the Timer Synchronous Print Mode (Auto Print Start/Stop Time)**

3. Press the  $\wedge$  or  $\vee$  key until "t , n E r" is displayed on display C.
4. Press the **ENTER** key.
5. "S t A r t" will be displayed on display B, and the currently selected print output start date is displayed on display C, with the digit on the extreme left blinking. You can change the value at the blinking digit. Pressing the  $\wedge$  key changes the value in the order 1, 2, 3 ... 9, 0 and back to 1. Pressing the  $\vee$  key changes the value in the opposite direction. The blinking position can be shifted to the left or right by pressing the  $<$  or  $>$  key respectively.  
After the desired start date has been set, press the **ENTER** key.

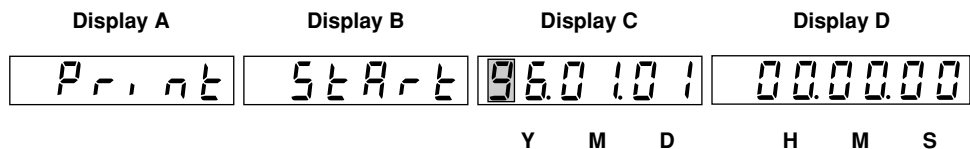



6. The currently selected print output start time will be displayed on display D, with the digit on the extreme left blinking. Set the start time in the same way as step 5. After the desired start time has been set, press the **ENTER** key.
7. "5 6 0 P" will be displayed on display B, and the currently selected print output stop date is displayed on display C, with the digit on the extreme left blinking. Set the stop date in the same way as step 5. After the desired stop date has been set, press the **ENTER** key.
8. The currently selected print output stop time will be displayed on display D, with the digit on the extreme left blinking. Set the stop time in the same way as step 5. After the desired start time has been set, press the **ENTER** key.

**Setting the Print Interval**

In auto print mode, measured values are printed out automatically at intervals. Set the print interval as follows.

9. "1 0 0 0 0" is displayed on display C, and the currently selected print interval is displayed on display D, with the digit on the extreme left blinking.

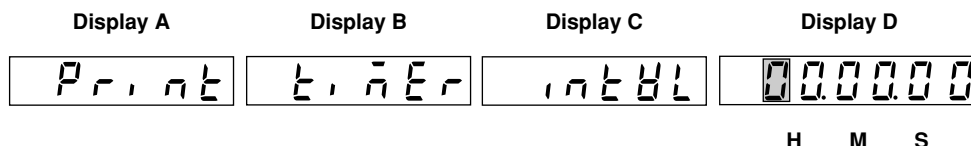

Set the print interval in the same way as step 5.

Allowable minimum interval : 10 s (Error code "E r r 1 2" will be displayed if a value below 10 s is set.)

Allowable maximum interval : 99 h 59 min 59 s

After the print interval has been set, press the **ENTER** key.

Measured values will be printed automatically as described in "Executing Auto Print" in the next page.

**Setting the Integration Synchronous Print Mode**

**Print timing when integration starts before depression of the AUTO key**

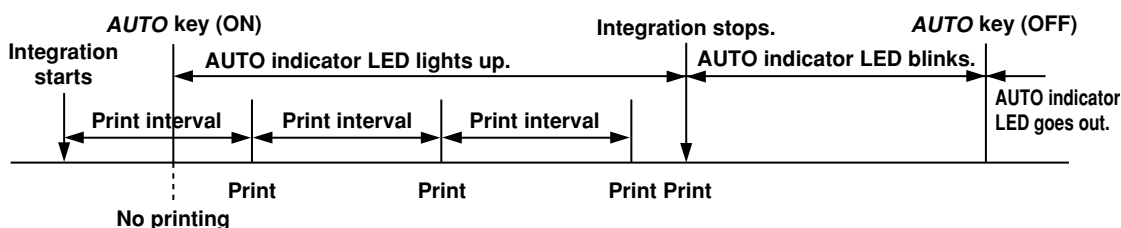

**Print timing when integration starts after depression of the AUTO key**

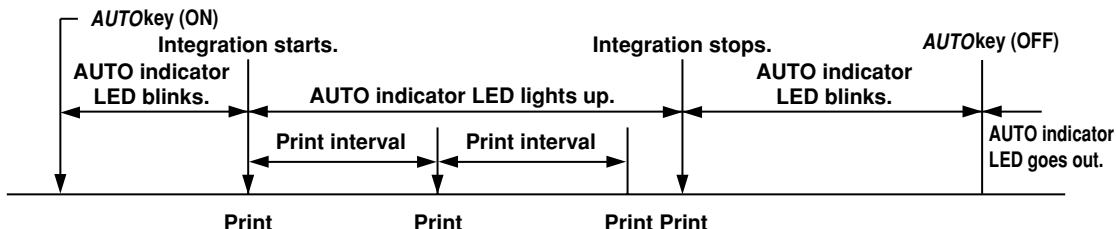

After steps 1 and 2 on the previous page, carry out the following steps

3. Press the  $\wedge$  or  $\vee$  key until "1 0 0 0 0" is displayed on display C.
4. Press the **ENTER** key.

## 11.4 Printing Measured Values in Manual or Auto Print Mode (Optional)

- " , n t H L " will be displayed on display C, and the currently selected print interval is displayed on display D, with the digit on the extreme left blinking.

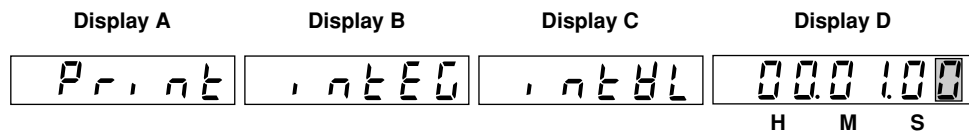

You can change the value at the blinking digit. Pressing the  $\wedge$  key changes the value in the order 1, 2, 3 ... 9, 0 and back to 1. Pressing the  $\vee$  key changes the value in the opposite direction.

Allowable minimum interval : 10 s (Error code " E r r 1 2 " will be displayed if a value below 10 s is set.)

Allowable maximum interval : 99 h 59 min 59 s

After the print interval has been set, press the **ENTER** key.

Follow the procedure given on the next page to execute auto print.

### Setting the Flicker Synchronous Print Mode

Print timing when voltage fluctuation/flicker measurement starts before depression of the **AUTO** key

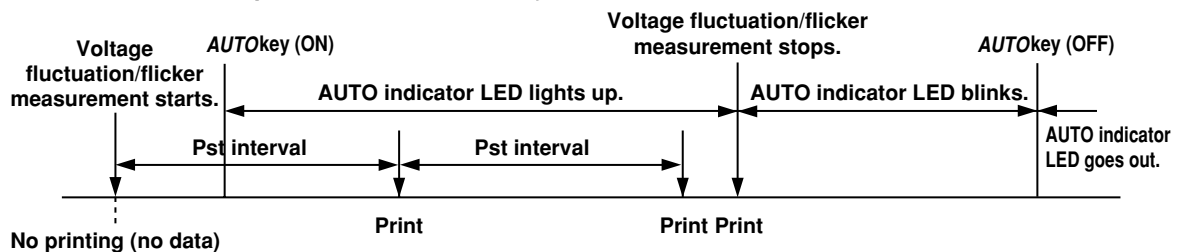

Print timing when voltage fluctuation/flicker measurement starts after depression of the **AUTO** key

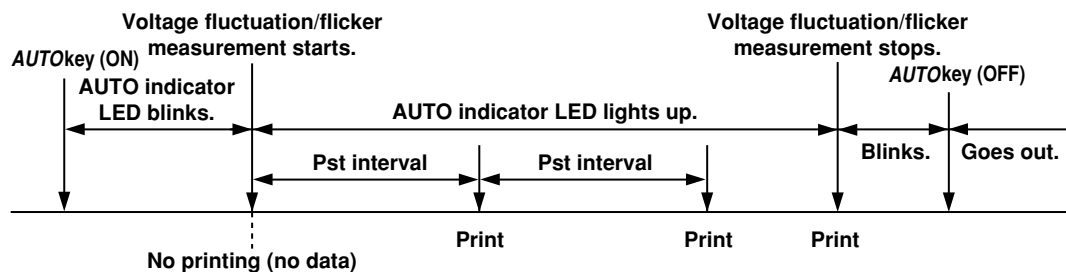

- Press the  $\wedge$  or  $\vee$  key until " F L , [ H " is displayed on display C. After steps 1 and 2 on page 11-8, carry out the following steps.

- Press the **ENTER** key. Measured values will be printed automatically as described below.

### Executing Auto Print

- Press the **AUTO** key.

The AUTO indicator LED will light up, indicating that the auto print function is ready. Auto printing will be executed according to the settings made. Pressing the **AUTO** key will cause the LED to go out.

### Note

- If the mode is switched from normal measurement mode to harmonic analysis mode while printing is in progress, the printer will stop and auto print mode is also canceled.

### Stopping Print Out

To stop printing while printing is in progress, press the **ABORT** key (**SHIFT + FEED**).

## 12.1 External Input/Output Signals (Remote Control, D/A Output)

Use of external input/output signals enables remote control of the instrument as well as output of analog signals from the D/A converter (optional).

### Signal Input/Output Function

The remote control/analog output connector can be used for the following purposes.

- To start, stop and reset integration (**INTEGRATOR START**, **STOP** and **RESET** keys)  
→ Refer to Section “12.2 Remote Control” (page 12-2).
- To hold and update displayed data (**HOLD** and **TRIG** keys)  
→ Refer to Section “12.2 Remote Control” (page 12-2).
- To output measured/computed data as an analog signal  
→ Refer to Section “12.3 D/A Output (Optional)” (page 12-4).

### Pin Assignment

The table below shows the pin assignment of the remote control/analog output connector.

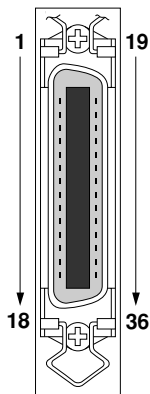

| Pin No. | Signal Name       | Pin No. | Signal Name           |
|---------|-------------------|---------|-----------------------|
| 1       | GND               | 19      | GND                   |
| 2       | EXT HOLD (input)  | 20      | EXT TRIG (input)      |
| 3       | EXT START (input) | 21      | EXT STOP (input)      |
| 4       | EXT RESET (input) | 22      | INTEG BUSY (output)   |
| 5       | EXT PRINT (input) | 23      | FLICKER BUSY (output) |
| 6       | N.C.              | 24      | N.C.                  |
| 7       | N.C.              | 25      | N.C.                  |
| 8       | N.C.              | 26      | N.C.                  |
| 9       | N.C.              | 27      | N.C.                  |
| 10      | D/A GND           | 28      | D/A GND               |
| 11      | D/A GND           | 29      | D/A GND               |
| 12      | CH1 (output)      | 30      | CH2 (output)          |
| 13      | CH3 (output)      | 31      | CH4 (output)          |
| 14      | CH5 (output)      | 32      | CH6 (output)          |
| 15      | CH7 (output)      | 33      | CH8 (output)          |
| 16      | CH9 (output)      | 34      | CH10 (output)         |
| 17      | CH11 (output)     | 35      | CH12 (output)         |
| 18      | CH13 (output)     | 36      | CH14 (output)         |

#### Note

- For the location of the connector, refer to Section 1.4 “Part Descriptions and Functions” (page 1-6.)
- The GND pins (pins 1 and 19) and D/A GND pins (pins 10, 11, 28 and 29) are connected internally to the case.
- For remote control, refer to Section 12.2, “Remote Control” (page 12-2.)
- For D/A outputs, refer to Section 12.3 “D/A Output (Optional)” (page 12-4.)



#### WARNING

- The connectors used in this function have protective covers. When the covers are removed or when using connectors, the voltage ratings across the measuring input and the ground become as follows:

Voltage across A,  $\pm(V$  and A side) input terminals and ground 400 Vrms max.

Voltage across V terminal and ground 600 Vrms max.

Put the protective cover on the connector when this function is not used.



#### CAUTION

- Never short-circuit the D/A output terminals or apply any external voltage to them, otherwise damage to the instrument may result.

# 12.2 Remote Control

## Controlling Integration

To control integration, apply signals according to the timing chart below.

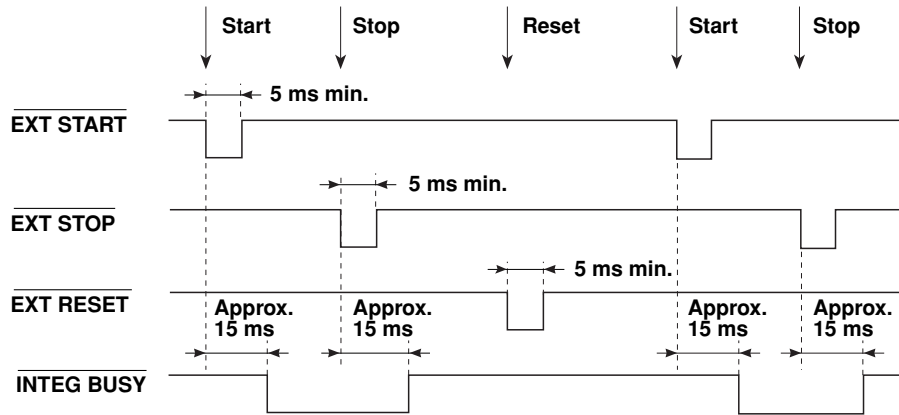

As shown in the timing chart, the INTEG BUSY output signal level goes low while integration is in progress. This signal can be used to monitor integration etc.

## Holding Display Data Update and Updating Display Data

### Holding Display Data Update (same function as HOLD key)

To hold the display data update, apply the EXT HOLD signal according to the timing chart below.

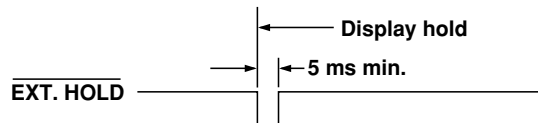

### Updating Display Data (same function as TRIG key)

Applying an EXT TRIG signal when the display data is on hold updates the display data.

#### Update timing

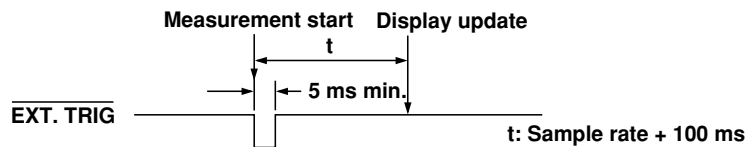

### Printing Measured Values to the Built-in Printer (Optional)

To print measured values to the built-in printer, apply the EXT PRINT signal according to the timing chart below.

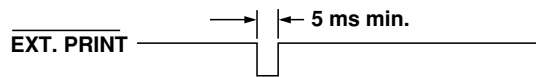

### The FLICKER BUSY Signal

As shown in the bellow timing chart, the FLICKER BUSY output signal level goes low while fluctuation measurement is in progress. This signal can be used to monitor fluctuation measurement etc .

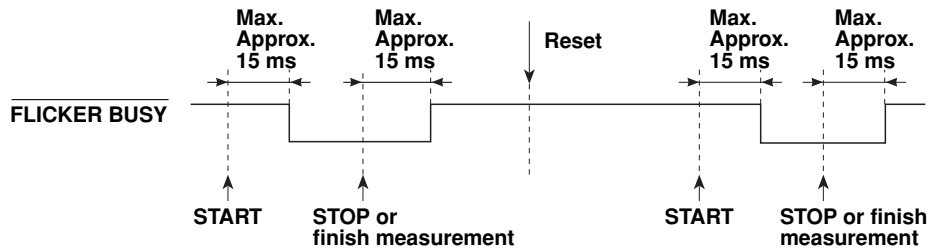

### Remote Control Circuit

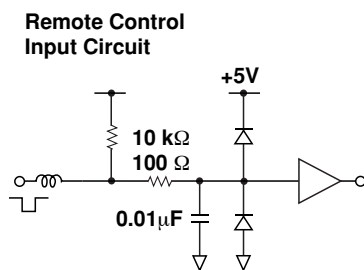

TTL level  
L: 0 to 0.8 V  
H: 2.0 to 5 V

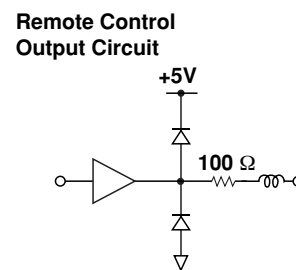

TTL level  
L: 0 to 0.4 V (8 mA)  
H: 2.4 to 5 V (-400 μA)



#### CAUTION

- Never apply a voltage exceeding the TTL level to the EXT.HOLD, EXT.TRIG and EXT.PRINT pins, otherwise damage to the instrument will result.

#### Note

- For the pin assignment, refer to Section 12.1 "External Input/Output Signals (Remote Control and D/A Output Signals)

## 12.3 D/A Output (Optional)

### Setting D/A Output

Measured/computed data or harmonic analysis data (analog signal) can be output from the D/A output terminals of the external input/output connector on the rear panel. Up to 14 items (14 channels) can be output.

#### Selecting the D/A Output Setting Menu

1. Press the **MISC** key (**SHIFT** + **□**.)  
Press the **∧** or **∨** key to display "dA-out" on display D.

2. Press the **ENTER** key. The currently selected output function will be displayed on display B.

Default setting : "no r" (output function for normal measurement)

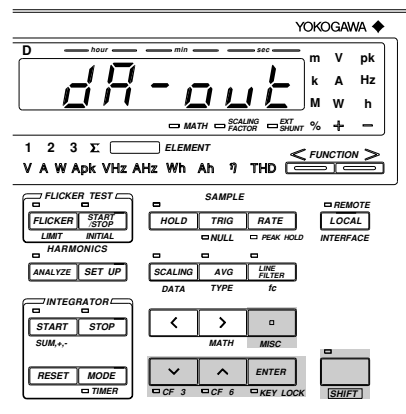

#### Selecting Output Function

3. Press the **∧** or **∨** key to select the desired output function.  
no r : Used to select output items for normal measurement.  
HAr : Used to select output items for harmonic analysis (optional).

4. Press the **ENTER** key.

#### Selecting Output Format

The output format currently selected is displayed on display C.

5. Press the **∧** or **∨** key to select the desired output format.

The following three output formats are available. For a description of each output item, refer to the following pages.

dFlLl - 1 : Default output items are selected. (Refer to next pages.)

dFlLl - 2 : Default output items are selected. (Refer to next pages.)

SEl : Desired output items can be selected manually.

6. Press the **ENTER** key.

If "SEl" is selected, the D/A output channel setting screen is displayed on display C, and the D/A output item and element setting screen is displayed on display D.

- When "no r" (normal measurement) is selected as the output function:

Display C

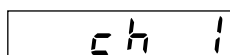

Display D

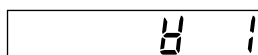

- When "HAr" (harmonic analysis) is selected as the output function:

Display C

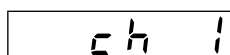

Display D

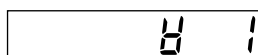

- If "SEl" has been selected, carry out the steps given on page 12-7.

**Output Items when "n o r" is Selected as the Output Function and "d f l t - 1" is Selected on Display C:**

- The numbers indicate the element No.

| Output Channel | Output Item                 |              |
|----------------|-----------------------------|--------------|
| ch1            | V1                          | Voltage      |
| ch2*1          | V2                          | Voltage      |
| ch3            | V3                          | Voltage      |
| ch4*2          | V4 ( $\Sigma$ )             | Voltage      |
| ch5            | A1                          | Current      |
| ch6*1          | A2                          | Current      |
| ch7            | A3                          | Current      |
| ch8*2          | A4 ( $\Sigma$ )             | Current      |
| ch9            | W1                          | Active power |
| ch10*1         | W2                          | Active power |
| ch11           | W3                          | Active power |
| ch12*2         | W4 ( $\Sigma$ )             | Active power |
| ch13           | Measured value on display C |              |
| ch14           | Measured value on display D |              |

\*1 : No data will be output for the three-phase, three-wire model (253102).

\*2 : If the single-phase, two-wire system is selected, "0V" (no data) will be output for W4 ( $\Sigma$ ), Wh4 ( $\Sigma$ ) and Ah4 ( $\Sigma$ ).

**Output Items when "n o r" is Selected as the Output Function and "d f l t - 2" is Selected on Display C:**

- The numbers indicate the element No.

| Output Channel | Output Item      |                             |
|----------------|------------------|-----------------------------|
| ch1            | W1               | Active power                |
| ch2*1          | W2               | Active power                |
| ch3            | W3               | Active power                |
| ch4*2          | W4 ( $\Sigma$ )  | Active power                |
| ch5            | Wh1              | watt-hour                   |
| ch6*1          | Wh2              | watt-hour                   |
| ch7            | Wh3              | watt-hour                   |
| ch8*2          | Wh4 ( $\Sigma$ ) | watt-hour                   |
| ch9            | Ah1              | ampere-hour                 |
| ch10*1         | Ah2              | ampere-hour                 |
| ch11           | Ah3              | ampere-hour                 |
| ch12*2         | Ah4 ( $\Sigma$ ) | ampere-hour                 |
| ch13           | Hz               | Measured frequency          |
| ch14           | HM               | Elapsed time of integration |

\*1 : No data will be output for the three-phase, three-wire model (253102).

\*2 : If the single-phase, two-wire system is selected, "0V" (no data) will be output.

**Output Items when "HAr" is Selected as the Output Function and "dFLt - 1" is Selected on Display C:**

- The numbers indicate the element No.

| Output Channel | Output Item |  |
|----------------|-------------|--|
| ch1            | A1 1st      | 1st harmonic component data of current of element 1  |
| ch2            | A1 2nd      | 2nd harmonic component data of current of element 1  |
| ch3            | A1 3rd      | 3rd harmonic component data of current of element 1  |
| ch4            | A1 4th      | 4th harmonic component data of current of element 1  |
| ch5            | A1 5th      | 5th harmonic component data of current of element 1  |
| ch6            | A1 6th      | 6th harmonic component data of current of element 1  |
| ch7            | A1 7th      | 7th harmonic component data of current of element 1  |
| ch8            | A1 8th      | 8th harmonic component data of current of element 1  |
| ch9            | A1 9th      | 9th harmonic component data of current of element 1  |
| ch10           | A1 10th     | 10th harmonic component data of current of element 1 |
| ch11           | A1 11th     | 11th harmonic component data of current of element 1 |
| ch12           | A1 12th     | 12th harmonic component data of current of element 1 |
| ch13           | A1 13th     | 13th harmonic component data of current of element 1 |
| ch14           | Hz          | PLL source frequency                                 |

**Note**

- If the upper limit of the harmonic order is 12th or below, harmonic component data up to the upper limit of the harmonic order only will be output. "0V" (no data) will be output for the harmonic component data exceeding the upper limit of the harmonic order.

**Output Items when "HAr" is Selected as the Output Function and "dFLt - 2" is Selected on Display C:**

- The numbers indicate the element No.

| Output Channel | Output Item |   |
|----------------|-------------|---|
| ch1            | A1 1st      | 1st harmonic component data of current of element 1 |
| ch2            | A1 3rd      | 3rd harmonic component data of current of element 1 |
| ch3            | A1 5th      | 5th harmonic component data of current of element 1 |
| ch4            | A1 7th      | 7th harmonic component data of current of element 1 |
| ch5*           | A2 1st      | 1st harmonic component data of current of element 2 |
| ch6*           | A2 3rd      | 3rd harmonic component data of current of element 2 |
| ch7*           | A2 5th      | 5th harmonic component data of current of element 2 |
| ch8*           | A2 7th      | 7th harmonic component data of current of element 2 |
| ch9            | A3 1st      | 1st harmonic component data of current of element 3 |
| ch10           | A3 3rd      | 3rd harmonic component data of current of element 3 |
| ch11           | A3 5th      | 5th harmonic component data of current of element 3 |
| ch12           | A3 7th      | 7th harmonic component data of current of element 3 |
| ch13           | DEG1        | Phase angle between fundamentals                    |
| ch14           | Hz          | PLL source frequency                                |

\* : No data will be output for the three-phase, three-wire model (253102).

**Note**

- If the upper limit of the harmonic order is 6th or below, harmonic component data up to the upper limit of the harmonic order only will be output. "0V" (no data) will be output for the harmonic component data exceeding the upper limit of the harmonic order.



**Selecting the Output Item and Element when "Σ E L" is Selected on Display C****Selecting the D/A Output Channel**

5. Press the  $\wedge$  or  $\vee$  key to select the desired output channel.
6. Press the **ENTER** key.

**Selecting the Output Item and Element**

7. Press the  $\wedge$  or  $\vee$  key to select the desired output item.

**Output Items which can be Selected: When "n o r" is Selected as the Output Function**

|                 |                               |                                 |
|-----------------|-------------------------------|---------------------------------|
| V (V)           | A (A)                         | P (W)                           |
| VA (VA)         | var (var)                     | PF (PF)                         |
| Frq (Frq)       | Wh (Wh)                       | WhP (WhP)                       |
| WhM (WhM)       | Ah (Ah)                       | AhP (AhP)                       |
| AhM (AhM)       | deg (deg)                     | V peak (V peak)                 |
| A peak (A peak) | Efficiency, computation etc.) | t (Elapsed time of integration) |

**Output Items which can be Selected: When "H R r" is Selected as the Output Function**

|                       |                        |                        |
|-----------------------|------------------------|------------------------|
| V (V)                 | A (A)                  | P (W)                  |
| VA (VA)               | var (var)              | PF (PF)                |
| Frq (Frequency *1)    | deg (Phase angle)      | Distortion of voltage  |
| Distortion of current | Content of voltage     | Content of current     |
| Content of power      | Phase angle of voltage | Phase angle of current |

\*1 : PLL source frequency

8. Press the  $>$  key. Now, an element can be selected. Press the  $\wedge$  or  $\vee$  key to select the desired element.

**Elements Which can be Selected**

- 1 : Element 1
- 2 : Element 2 (Not available with the three-phase, three-wire model (253102))
- 3 : Element 3
- 4 : Element  $\Sigma$  (Not possible to select Vpeak and Apeak. V, A, W, VA, var and PF of fundamental only can be selected if "H R r" has been selected as the output function.)

It is not possible to select any element for frequency, efficiency/computation or elapsed time of integration.

9. Press the **ENTER** key.  
If "n o r" has been selected, carry out from step 11 on the following page.

**Setting the Order**

10. If "H H r" is selected as the output format, select the desired order on display D.  
 Press the  $\wedge$  or  $\vee$  key to select the order within the following range.  
 Allowable range: 0 to 50  
 It is possible to select "0" for V, A and W only. If "0" is selected, the total rms value will be output.  
 After the desired order has been selected, press the **ENTER** key.
11. The next D/A output channel no. will begin to blink automatically.
12. Repeat steps 5 to 9 to set the desired output items and element for each channel.

**Quitting Setting Mode**

13. To exit from setting mode, follow the procedure below.  
 After all 14 channels have been set, "E r d" is displayed in the channel setting screen (display B or C). To quit setting mode, press the **ENTER** key. To continue making settings, press the  $\wedge$  or  $\vee$  key to select the desired channel no.  
 To exit from setting mode in the middle of making settings, press the  $\square$  (**MISC**) or **SHIFT** key.

**Note**

---

- When "H H H" (efficiency/computation) is selected, 0 V is output from the D/A converter unless EFF is selected as the MATH function.
  - If the scaling value has been set for voltage, current and power, a voltage of 5.0 V (full scale) will be output from the D/A converter when the rated value is input.
  - If the scaling values set for each element differ from each other in the case of element  $\Sigma$ , the number of display digits will be limited so that  $\Sigma$  value does not exceed 50000 when the rated value is input to each corresponding element. A voltage of 5.0 V (full scale) will be output from the D/A converter as the  $\Sigma$  value obtained when the rated value is input to each corresponding element.
  - The following frequency data will be output from the D/A converter.
 

|                           |   |
|---------------------------|---|
| During normal measurement | : Frequency selected on display D or frequency of the function previously selected on display D |
| During harmonic analysis  | : Frequency of PLL source   |
- 

**Setting Rated Integration Time when Outputting Integrated Values from the D/A Converter**

1. Press the **MISC** key (**SHIFT** +  $\square$ ).  
 Press the  $\wedge$  or  $\vee$  key to display "r t - t" on display D.
2. Press the **ENTER** key.  
 The rated integration time currently set will be displayed on display B. Set the desired time using the  $\wedge$ ,  $\vee$ ,  $<$  and  $>$  keys.  
 Minimum time allowed : 1 min  
 Maximum time allowed : 999 h 59 min
3. When the rated integration time has been set, press the **ENTER** key.

## Output Items and D/A Output Voltage

### Frequency

When the sample rate is set to 250ms or 2s:

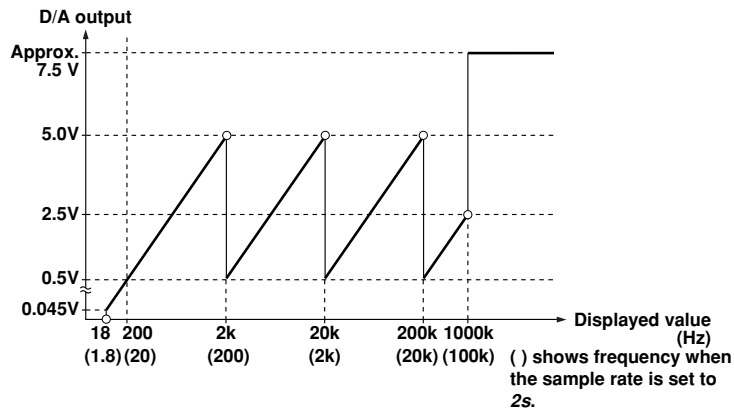

When the sample rate is set to 500ms:

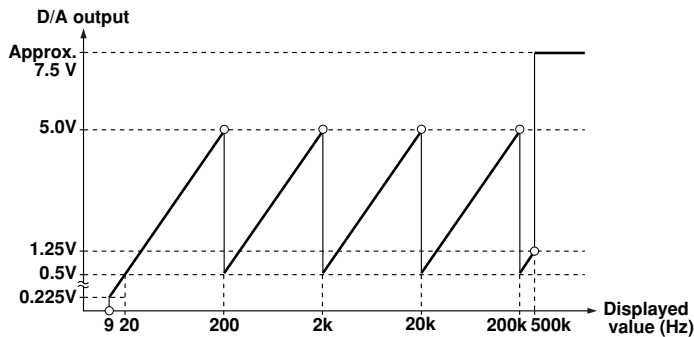

### Integrated Value

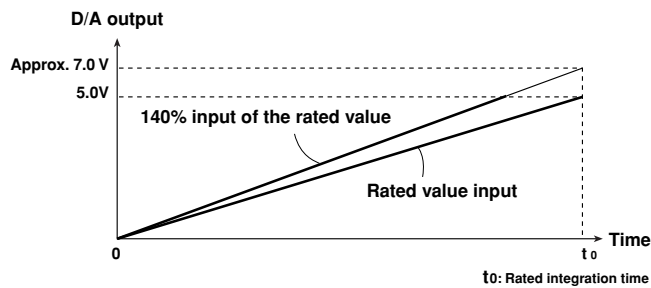

### Other Items

| Displayed Value | Output        |
|-----------------|---------------|
| 140%            | Approx. 7.0V  |
| 100%            | 5.0V          |
| 0%              | 0V            |
| -100%           | -5.0V         |
| -140%           | Approx. -7.0V |

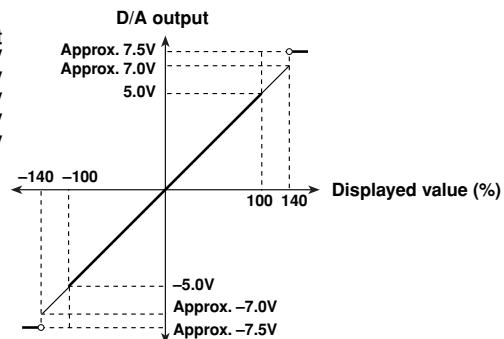

- The maximum output level is  $\pm 5.0$  V for power factor (PF) and phase angle (deg). However, the output will be approx.  $+7.5$  V if there is an error.
- If the selected phase angle display method is for  $0^\circ$  to  $360^\circ$ , the output will be between 0 V and  $+5$  V. If the method is for phase lag  $180^\circ$  to phase lead  $180^\circ$ , the output will be between  $-5.0$  V and  $+5.0$  V. The output will be approx.  $7.5$  V if there is a phase angle error.
- For efficiency computation, THD (optional) and content (optional),  $+5$  V will be output when they are 100%.

# 13.1 Storing, Recalling and Initializing Set-up Information

## Storing

1. Press the **MISC** key (**SHIFT** +  $\square$ .)  
Press the  $\wedge$  or  $\vee$  key until "StorE" appears on display D.
2. Press the **ENTER** key.  
"FILE" will be displayed on display B.
3. Press the  $\wedge$  or  $\vee$  key to select the file no. of the built-in memory where the set-up information is to be stored.  
Files from FILE1 to FILE4 are available in the built-in memory.  
The state of the selected file will be displayed on display C.  
If any set-up information already exists in the selected file, the storage date will be displayed.

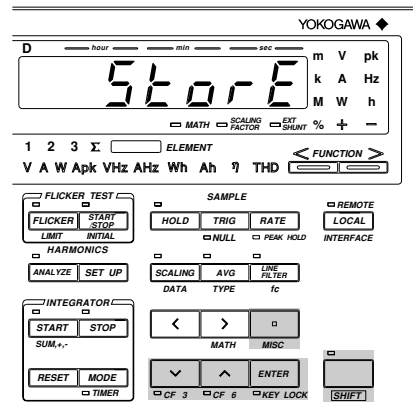

4. Press the **ENTER** key.  
The current set-up information will be stored into the file selected in step 3. If any set-up information already exists in the file, the information will be replaced by the current information. Note that the old information will be deleted.

### Note

- If the power is turned OFF during storage of the set-up information, not only the file to which the set-up information is being stored will be damaged, but also other files may be initialized.

Recall

1. Press the **MISC** key (**SHIFT** +  $\square$ ).  
Press the  $\wedge$  or  $\vee$  key until "r E E A L L" appears on display D.
2. Press the **ENTER** key.  
"F r L E I" will be displayed on display B.
3. Press the  $\wedge$  or  $\vee$  key to select the file no. of the built-in memory where the set-up information is to be recalled.  
The state of the selected file will be displayed on display C.  
If any set-up information already exists in the selected file, the storage date will be displayed. If not, "F r E E" will be displayed.
4. Press the **ENTER** key.  
The set-up information currently stored in the file selected in step 3 will be recalled. If there is no set-up information in that file, "E r r 3 0" error code will be displayed on display D.

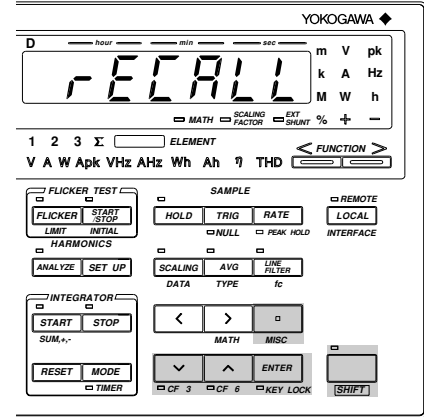

Note

- If the power is turned OFF during recalling of the set-up information, "E r r 6 0" will occur when the power is turned ON again, possibly causing the instrument to be initialized.
- If an attempt is made to recall a file containing voltage fluctuation/flicker measurement data during harmonic analysis, "E r r 1 6" will occur.
- If an attempt is made to recall a file containing harmonic analysis data during voltage fluctuation/flicker measurement, "E r r 2 0" will occur.

Initialization

1. Press the **MISC** key (**SHIFT** +  $\square$ ).  
Press the  $\wedge$  or  $\vee$  key until "r E E E E t" appears on display D.
2. Press the **ENTER** key.  
"r E E E E t" will shift to display C, and "r 0" begins to blink on display D.  
If you do not want to initialize the set-up information, press the **ENTER** key.
3. To initialize the set-up information, press the  $\wedge$  or  $\vee$  key until "y E E 5" appears, then press the **ENTER** key.

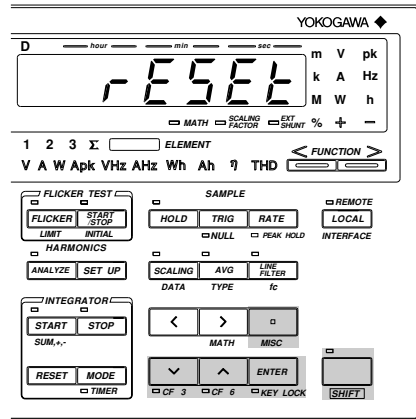

The set-up information will be initialized.  
All set-up information will be set as shown on page 2-6.

Note

- All measurement data will be lost when initialization is carried out.
- If the power is turned OFF during initialization, "E r r 6 0" may occur when the power is turned ON again, possibly causing the instrument to be initialized.

## 13.2 Key Lock Function

The key lock function is provided to prevent key operations during measurement. Operation of all panel keys except the **POWER** and **SHIFT** keys will be disabled.

### Enabling Key Lock Function

Press the **KEY LOCK** key (**SHIFT** + **ENTER**). The KEY LOCK indicator LED will light up.

### Disabling Key Lock Function

Press the **KEY LOCK** key (**SHIFT** + **ENTER**) when the KEY LOCK indicator LED is lit. The LED will go out.

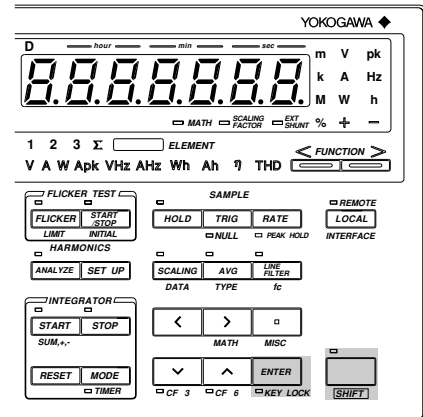

## 13.3 Backup Function for Set-up Information

The instrument is equipped with a lithium battery to provide battery backup for the set-up information in case of power failure. The battery lasts for approximately ten years (page 2-5.)

The following set-up information can be backed up.

Date  
 Time  
 Wiring system  
 Voltage ranges, auto range ON/OFF  
 Current ranges, auto range ON/OFF  
 Measurement voltage and current modes for each element  
 Sample rate  
 External shunt  
 Data hold  
 Line filter ON/OFF, cut-off frequency  
 Scaling ON/OFF  
 Scaling constant  
 Averaging ON/OFF  
 Averaging type  
 Attenuation constant  
 Function and element selected for each display  
 Peak hold ON/OFF peak hold Function  
 Frequency filter ON/OFF  
 NULL function ON/OFF  
 Crest factor  
 Phase angle display format  
 MATH settings  
 Key lock  
 Communication output mode  
 Communication output function ON/OFF  
 Communication output type  
 Communications command  
 Delimiter  
 Presence/absence of header  
 Output interval during talk-only  
 GP-IB address (When equipped with a GP-IB interface)  
 Handshake mode  
 Data format  
 Baud rate  
 Integration mode  
 Integration timer preset time  
 Integration start/stop time  
 Integrated value  
 Elapsed time of integration  
 Integration polarity setting  
 Harmonic analysis ON/OFF  
 PLL source  
 Harmonic analysis display format  
 Harmonic analysis display order  
 Upper limit of the harmonic order setting  
 THD computing method  
 Anti-aliasing filter ON/OFF  
 Harmonic analysis window width  
 Print mode  
 Print interval  
 Print start/stop time  
 Print synchronization  
 Print output function ON/OFF  
 D/A output function (normal)  
 D/A output function (harmonic analysis)  
 Rated integration time for D/A outputs  
 Flicker measurement ON/OFF  
 Input method for nominal voltage, voltage value when an existing value  
 is to be used  
 Judgment ON/OFF and limits for relative steady-state voltage change dc, maximum  
 relative voltage change  $d_{max}$  and the period  $d(t)$  200ms during which relative  
 voltage change exceeds the threshold level during a voltage change  
 Judgment ON/OFF and limits for short-term flicker value and long-term flicker value  
 Constant for the long-term flicker value equation, time required for measurement  
 of short-term flicker value, number of times measurement is carried out  
 Steady-state range  
 Flicker measurement element ON/OFF

(When equipped with a RS-232-C interface)  
 (When equipped with a RS-232-C interface)  
 (When the harmonic analysis function (optional) is incorporated)  
 (When a built-in printer (optional) is incorporated)  
 (When the D/A output function (optional) is incorporated)  
 (When the flicker measurement function (optional) is incorporated)

# 14.1 Selecting the Output Items

Output items can be selected from the controller (computer) or panel. The communications function is used to output data to a listener-only device such as a printer.

## Procedure

### Selecting the Output Item Setting Menu

1. Press the **MISC** key (**SHIFT** + **□**).  
Press the **∧** or **∨** key until "□ - □ □ □" is displayed on display D.

2. Press the **ENTER** key. The currently selected output function will be displayed on display B.

Default setting : "□ □ □" (output function for normal measurement)

### Selecting Output Function

3. Press the **∧** or **∨** key to select the desired output function.

- □ □ : Used to select output items for normal measurement (normal measurement or integration measurement).
- □ □ : Used to select output items for harmonic analysis (optional).
- □ □, □ □ □ : Used to select output items for flicker measurement (optional).
- - □ □ □ : Used to select the output data format (ASCII or binary).

4. Press the **ENTER** key.

### Selecting Output Format

The output format currently selected is displayed on display C.

5. Press the **∧** or **∨** key to select the desired output format.

The following output formats are available. For details, refer to the following pages.

- □ □ □ - 1 : Default items are output.
- □ □ □ - 2 : Default items are output.
- □ □ □ : All items are output.
- □ □ □ : Desired items can be selected manually.
- □ □ □ □ : No items are output.
- □ □ □ □ : Items are output in ASCII format (available only when "□ - □ □ □" is selected in step 3)
- , □ □ □ □ : Items are output in binary format (available only when "□ - □ □ □" is selected in step 3)

6. Press the **ENTER** key.

If "□ □ □" is selected in step 5, the output item and element setting menu will be displayed on display C, and the output ON/OFF state is displayed on display D.

### Selecting the Output Item and Element when "□ □ □" is Selected on Display C

7. The currently set output item and element are displayed on display C. Press the **∧** or **∨** key to select the desired item.

8. Press the **>** key. Now, an element can be selected. Press the **∧** or **∨** key to select the desired element.

Elements Which can be Selected:

- 1 : Element 1
- 2 : Element 2 (Not available with the three-phase, three-wire model (253102))
- 3 : Element 3
- 4 : Element Σ (Cannot be selected if Vpeak or Apeak is selected when "□ □ □" or "□ □ □, □ □ □" has been selected as the output function. V, A, W, var, VA and PF of the fundamental only can be selected if "□ □ □" has been selected as the output function.)

It is not possible to select any element for efficiency/computation or elapsed time of integration.

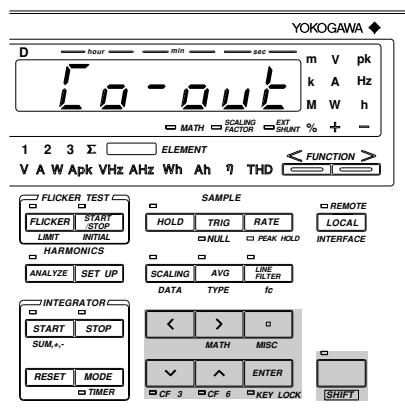



9. Press the **ENTER** key.  
The data displayed on display D begins to blink automatically.  
Press the  $\wedge$  or  $\vee$  key to select whether or not the selected item is to be output.

10. Repeat steps 7 to 9 until all the desired output items have been selected.

**Quitting Setting Mode**

11. To exit from setting mode, press the **MISC** or **SHIFT** key.

**Description of Output Items**

**Selectable Output Items when "n o r" is Selected as the Output Function and "d f l t - l" is Selected on Display C:**

|    |      |    |        |                    |
|----|------|----|--------|--------------------|
| V1 | V2*1 | V3 | V4 (Σ) | Voltage            |
| A1 | A2*1 | A3 | A4 (Σ) | Current            |
| W1 | W2*1 | W3 | W4 (Σ) | Active power       |
| Hz |      |    |        | Measured frequency |

\*1 : Not possible with the three-phase, three-wire model (253102).

**Selectable Output Items when "n o r" is Selected as the Output Function and "d f l t - z" is Selected on Display C:**

|      |        |      |          |                             |
|------|--------|------|----------|-----------------------------|
| W1   | W2*1   | W3   | W4 (Σ)   | Active power                |
| Wh1  | Wh2*1  | Wh3  | Wh4 (Σ)  | Watt-hour                   |
| Wh+1 | Wh+2*1 | Wh+3 | Wh+4 (Σ) | Positive watt-hour          |
| Wh-1 | Wh-2*1 | Wh-3 | Wh-4 (Σ) | Negative watt-hour          |
| Ah1  | Ah2    | Ah3  | Ah4 (Σ)  | Ampere-hour                 |
| Ah+1 | Ah+2*1 | Ah+3 | Ah+4 (Σ) | Positive ampere-hour        |
| Ah-1 | Ah-2*1 | Ah-3 | Ah-4 (Σ) | Negative ampere-hour        |
| Hz   |        |      |          | Measured frequency          |
| HM   |        |      |          | Elapsed time of integration |

\*1 : Not possible with the three-phase, three-wire model (253102).

**Selectable Output Items when "H A r" is Selected as the Output Function and "d f l t - l" is Selected on Display C:**

|       |         |       |   |
|-------|---------|-------|---|
| V1    | V2*1    | V3    | Total rms value of voltage and analysis value of each harmonic from 1st up to n*2th |
| A1    | A2*1    | A3    | Total rms value of current and analysis value of each harmonic from 1st up to n*2th |
| W1    | W2*1    | W3    | Total active power and analysis value of each harmonic from 1st up to n*2th         |
| VTHD1 | VTHD2*1 | VTHD3 | Harmonic distortion of voltage  |
| ATHD1 | ATHD2*1 | ATHD3 | Harmonic distortion of current  |
| VCON1 | VCON2*1 | VCON3 | Content of each harmonic (from 2nd up to n*2th) of voltage                          |
| ACON1 | ACON2*1 | ACON3 | Content of each harmonic (from 2nd up to n*2th) of current                          |
| WCON1 | WCON2*1 | WCON3 | Content of each harmonic (from 2nd up to n*2th) of active power                     |
| Hz    |         |       | PLL source frequency  |

\*1 : Not possible with the three-phase, three-wire model (253102).

\*2 : "n" is the upper limit of the harmonic order.

**Selectable Output Items when "H A r" is Selected as the Output Function and "d f l t - z" is Selected on Display C:**

|      |        |      |  |
|------|--------|------|--|
| DEG1 | DEG2*1 | DEG3 | Phase angle between fundamentals   |
| DGV1 | DGV2*1 | DGV3 | Phase angle of voltage of each harmonic from 2nd to n*2th in relation to voltage of the 1st harmonic |
| DGA1 | DGA2*1 | DGA3 | Phase angle of voltage of each harmonic from 2nd to n*2th in relation to current of the 1st harmonic |
| Hz   |        |      | PLL source frequency   |

\*1 : Not possible with the three-phase, three-wire model (253102).

\*2 : "n" is the upper limit of the harmonic order.

**Selectable Output Items when "Flicker" is Selected as the Output Function and "dFlicker-1" is Selected on Display C:**

|        |  |
|--------|--|
| Un1    | Nominal voltage  |
| dc1    | Relative steady-state voltage change                                     |
| dmax1  | Maximum relative voltage change  |
| dt1    | Period during which relative voltage change is above the threshold level |
| Pst1   | Short-term flicker value   |
| Plt1   | Long-term flicker value  |
| Total1 | Total judgment result  |
| VHz1   | Input voltage frequency  |
| time1  | Elapsed time   |

**Selectable Output Items when "Flicker" is Selected as the Output Function and "dFlicker-2" is Selected on Display C:**

|        |  |
|--------|--|
| dc1    | Relative steady-state voltage change                                     |
| dmax1  | Maximum relative voltage change  |
| dt1    | Period during which relative voltage change is above the threshold level |
| Pst1   | Short-term flicker value   |
| Plt1   | Long-term flicker value  |
| Total1 | Total judgment result  |
| time1  | Elapsed time   |

**List of Selectable Output Items**

**When "Power" is Selected as the Output Function:**

|                 |   |                                 |
|-----------------|---|---------------------------------|
| V (V)           | I (A)   | P (W)                           |
| VA (VA)         | var (var)   | PF (PF)                         |
| f (Frequency)   | Wh (Wh)   | WhP (WhP)                       |
| WhM (WhM)       | Ah (Ah)   | AhP (AhP)                       |
| AhM (AhM)       | deg (deg)   | V peak (V peak)                 |
| A peak (A peak) | Efficiency, computation etc. (Efficiency, computation etc.) | t (Elapsed time of integration) |

**When "Harmonics" is Selected as the Output Function**

|   |   |   |
|---|---|---|
| V (V)   | I (A)   | P (W)   |
| VA (VA)                                       | var (var)                                       | PF (PF)   |
| f (Frequency*1)                               | Phase angle (Phase angle)                       | Distortion of voltage (Distortion of voltage)   |
| Distortion of current (Distortion of current) | Content of voltage (Content of voltage)         | Content of current (Content of current)         |
| Content of power (Content of power)           | Phase angle of voltage (Phase angle of voltage) | Phase angle of current (Phase angle of current) |

\*1 : PLL source frequency

**When "Flicker" is Selected as the Output Function**

|   |   |
|---|---|
| Un (Nominal voltage)  | d (Relative steady-state voltage change)      |
| dmax (Maximum relative voltage change)  |   |
| dt (Period during which relative voltage change is above the threshold level) |   |
| Pst (Short-term flicker value)  | Plt (Long-term flicker value)                 |
| VHz (Input voltage frequency)   | t (Elapsed time)                              |
|   | Total judgment result (Total judgment result) |

**Note**

- If many output items are selected, it may take some time before they are output depending on the state of the instrument (sample rate, harmonic analysis, printing). In this case, reduce the number of output items or hold measurement.
- If you want to output data at high speed, select the binary format.

## 14.2 Using the GP-IB Interface

The instrument is equipped with a GP-IB interface in accordance with your preference. This interface permits remote control from a controller such as a personal computer, and output of various data.

### Overview of the GP-IB Interface

The table below shows functions that are available in each mode.

| Mode                                 | Function |   |
|--------------------------------------|----------|---|
| Addressable mode (mode A and mode B) | Listener | <ul style="list-style-type: none"> <li>• Functions performed by front panel key operations (except for <b>LOCAL</b> key and power ON/OFF)</li> <li>• Measured/computed data output request</li> <li>• Panel set-up information output request</li> <li>• Error code output request</li> </ul> |
|                                      | Talker   | <ul style="list-style-type: none"> <li>• Measured/computed data output</li> <li>• Panel set-up information output</li> <li>• Error code output</li> <li>• Status byte output</li> </ul>   |
| Talk-only mode                       | Talker   | Measured/computed data output   |

#### Addressable Mode A

Measured data is output when an "OD" (measured data output request command) is received. This mode enables transmission of measured data at a specified time.

#### Addressable Mode B

This mode does not require a measured data query command. When measured data is requested by the controller (personal computer etc.), the data is output as the display is updated when measurement is completed. Therefore, if an attempt is made to transmit measured data at intervals shorter than the display intervals, the controller is forced to wait until the next display interval.

#### 488.2 Mode

Protocol commands complying to IEEE St'd 488.2-1987 can be used.

#### Talk-only Mode

This mode does not require a controller. Measured data is output at certain intervals. The interval can be set to any length. This mode is useful when the instrument is connected to a listener-only device such as a printer.

### GP-IB Interface Specifications

|  |  |
|--|--|
| Electrical and mechanical specifications | : Conforms to IEEE Std 488-1978 (JIS C 1901-1987)  |
| Functional specifications                | : refer to the table blow.   |
| Code                                     | : ISO (ASCII) code   |
| Address setting                          | : listener and talker addresses 0 to 31 or talk-only can be selected using the front panel keys.   |
| Remote mode clear                        | : remote mode can be cleared by pressing the <b>LOCAL</b> key on the front panel. However, this is not possible if Local Lockout has been set by the controller. |

| Function             | Subset Name | Description  |
|----------------------|-------------|--|
| Source handshaking   | SH1         | Full source handshake capability   |
| Acceptor handshaking | AH1         | Full acceptor handshake capability   |
| Talker               | T5          | Basic talker capability, serial polling, untalk on MLA (My Listen Address), talk-only capability |
| Listener             | L4          | Basic listener capability, unlisten on MTA (My Talk Address), no listen-only capability          |
| Service request      | SR1         | Full service request capability  |
| Remote local         | RL1         | Full remote/local capability   |
| Parallel poll        | PP0         | No parallel polling capability   |
| Device clear         | DC1         | Full device clear capability   |
| Device trigger       | DT1         | Full device trigger capability   |
| Controller           | C0          | No controller function   |

## Response to Interface Messages

### IFC (Interface Clear)

Cancels (unaddresses) talker and listener.

### REN (Remote Enable)

Transfers the instrument from local control to remote control.

### GTL (Go To Local)

Transfers the instrument from remote control to local control.

### SDC (Selective Device Clear), DCL (Device Clear)

Clears GP-IB input/output buffer, and resets an error. The set-up information and measurement state are not affected.

DCL is applicable to all devices on the bus, whilst DSC is applicable only to designated devices.

### GET (Group Execute Trigger)

Same function as the **TRIG** key.

### LLO (Local Lockout)

Invalidates the **LOCAL** key on the front panel to inhibit transfer from remote control to local control.

## Switching between Remote and Local Mode

### When Transferred from Local to Remote Mode

The REMOTE indicator LED will light up. All front panel keys except the **LOCAL** key cannot be operated any more. Set-up information entered in local mode is retained.

### When Transferred from Remote to Local Mode

The REMOTE indicator LED will go out. All front panel keys can be operated. Set-up information entered in remote mode is retained.

### Valid Keys for Remote Control

Pressing the **LOCAL** key in remote control transfers the instrument to local control. However, this is not possible if Local Lockout has been set by the controller.



### WARNING

- The connectors used in this function have protective covers. When the covers are removed or when using connectors, the voltage ratings across the measuring input and the ground become as follows:
  - Voltage across A,  $\pm$ (V and A side) input terminals and ground 400 Vrms max.
  - Voltage across V terminal and ground 600 Vrms max.
- Put the protective cover on the connector when this function is not used.

## Setting the Address/Addressable Mode

### Procedure

#### Setting the Addressable/Talk-only Mode

Press the **LOCAL** key to display the mode setting screen on display B. Pressing the  $\wedge$  or  $\vee$  key changes the mode in the order of "AddrA"  $\rightarrow$  "AddrB"  $\rightarrow$  "488.2" and back to "AddrA".

Select the desired mode, then press the **ENTER** key.

#### Setting the Address

If addressable mode (AddrA, AddrB or 488.2) is selected, the address setting screen will be displayed on display D.

Press the  $\wedge$ ,  $\vee$ ,  $<$  or  $>$  key to select the desired address, then press the **ENTER** key.

#### Setting the Output Interval (when talk-only mode is selected)

If talk-only mode (tonly) is selected, the output interval setting screen will be displayed on display D.

Press the  $\wedge$ ,  $\vee$ ,  $<$  or  $>$  key to set the desired interval (in units of hour, minute and second), then press the **ENTER** key.

#### Setting the Sending Terminator (when mode except for 488.2 is selected)

When the address or output interval is set, the sending terminator setting screen will be displayed on display D.

Pressing the  $\wedge$  or  $\vee$  key changes the terminator in the order of  $\text{CR+LF} \rightarrow \text{LF} \rightarrow \text{EOI}$ , and back to  $\text{CR+LF}$ . Select the desired terminator, then press the **ENTER** key.

#### Note

- For 488.2 mode (command specified in IEEE488.2-1987), the sending terminator is fixed to LF. Thus, the sending terminator setting screen will not be displayed if 488.2 is selected.

### Description

#### Setting the Mode

For details, refer to page 14-4.

#### Setting the Address

A particular address is assigned to each device connected to the GP-IB interface so that each device can be recognized by every device. Therefore, an address must be assigned to this instrument when it is connected to a personal computer.

Setting range : 0 to 30

Default setting : 1

#### Setting the Output Interval

If talk-only mode is selected, it is necessary to set the intervals at which data is to be output.

Setting range : 00.00.00 (0 h 0 min 0 s) to 99.59.59 (99 h 59 min 59 s)

Default setting : 00.00.00

If the output interval is set to 00.00.00, data will be output at every sample rate.

#### Terminator

- When this instrument is used as a listener  
Use "CR+LF", "LF" or "EOI" as the receiving terminator.
- When this instrument is used as a talker  
Use "CR+LF+EOI", "LF" or "EOI" as the sending terminator. The default setting is "CR+LF+EOI".

#### Using an IEEE488.2-1987 Command

Select "488.2" in the mode setting screen. For a description of each command, refer to Appendix 2.

#### Note

- It is not possible for this instrument to receive data if only the "CR" terminator is sent from the controller. It is also not possible to set "CR" as the terminator which is to be sent from this instrument.

## 14.3 Using the RS-232-C Interface

The instrument is equipped with an RS-232-C interface in accordance with your preference. This interface permits remote control from a controller such as a personal computer, and output of various data.

### Overview of the RS-232-C Interface

The table below shows functions that are available in each mode.

| Mode           | Function     |   |
|----------------|--------------|---|
| Normal mode    | Reception    | <ul style="list-style-type: none"> <li>• Functions performed using front panel key operations (except for <b>LOCAL</b> key and power ON/OFF)</li> </ul>                                 |
|                |              | <ul style="list-style-type: none"> <li>• Measured/computed data output request</li> <li>• Panel set-up information output request</li> <li>• Error code output request</li> </ul>       |
|                | Transmission | <ul style="list-style-type: none"> <li>• Measured/computed data output</li> <li>• Panel set-up information output</li> <li>• Error code output</li> <li>• Status byte output</li> </ul> |
| Talk-only mode | Transmission | <ul style="list-style-type: none"> <li>• Measured/computed data output</li> </ul>   |

#### Normal Mode

This mode is equivalent to addressable mode A of the GP-IB interface function, and enables reception of commands and transmission of measured data. Measured data is output on reception of the OD command.

#### 488.2 Mode

The command being use at GP-IB complying to the IEEE St'd 488.2-1987 standard can be received.

#### Talk-only Mode

There is no mode that is equivalent to the addressable mode B of the GP-IB interface function with this instrument.

### RS-232-C Interface Specifications

|                            |  |
|----------------------------|--|
| Electrical characteristics | Conforms to EIA RS-232-C.  |
| Connection                 | Point-to-point   |
| Communications             | Full-duplex  |
| Synchronization            | Start-stop system  |
| Baud Rate                  | 75, 150, 300, 600, 1200, 2400, 4800 and 9600   |
| Start Bit                  | 1 bit  |
| Data Length (Word Length)  | 7 or 8 bits  |
| Parity                     | Even, odd or no parity   |
| Stop Bit                   | 1 or 2 bits  |
| Hardware Handshaking       | User can select whether CA and CB signals will always be True, or be used for control.   |
| Software Handshaking       | User can select whether to control only transmission or both transmission and reception using X-on and X-off signals.<br>X-on: ASCII 11H<br>X-off: ASCII 13H |
| Receive Buffer Size        | 256 bytes  |



#### WARNING

- **The connectors used in this function have protective covers. When the covers are removed or when using connectors, the voltage ratings across the measuring input and the ground become as follows:**

**Voltage across A,  $\pm$ (V and A side) input terminals and ground 400 Vrms max.**

**Voltage across V terminal and ground 600 Vrms max.**

**Put the protective cover on the connector when this function is not used.**

### Connecting the RS-232-C Interface Cable

When connecting this instrument to a personal computer, make sure that the handshaking method, data transmission rate and data format selected for the instrument match those selected for the computer. Also make sure that the correct interface cable is used.

### Connector and Signal Names

Numbers in the figure represent pin nos.

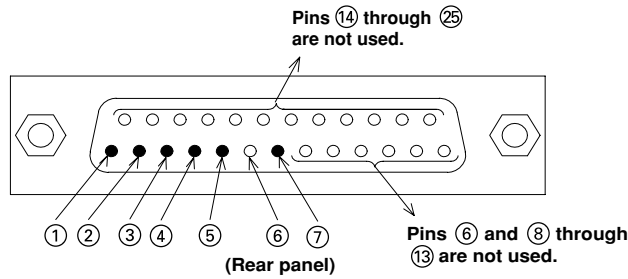

**RS-232-C connector: DBSP-JB25S or equivalent**

|   |                             |   |
|---|-----------------------------|---|
| 1 | AA (GND; Protective Ground) | Grounded to the case of this instrument.  |
| 2 | BA (TXD; Transmitted Data)  | Data transmitted to personal computer<br>Signal direction: Output                               |
| 3 | BB (BXD; Received Data)     | Data received from personal computer<br>Signal direction: Input                                 |
| 4 | CA (RTS; Request to Send)   | Signal used to handshake when receiving data from personal computer<br>Signal direction: Output |
| 5 | CB (CTS; Clear to Send)     | Signal used to handshake when transmitting data to personal computer<br>Signal direction: Input |
| 7 | AB (GND; Signal Ground)     | Ground for signals  |

**Note**

- Pins 6 and 8 through 25 are not used.

### Signal Direction

The figure below shows the direction of the signals used by the RS-232-C interface.

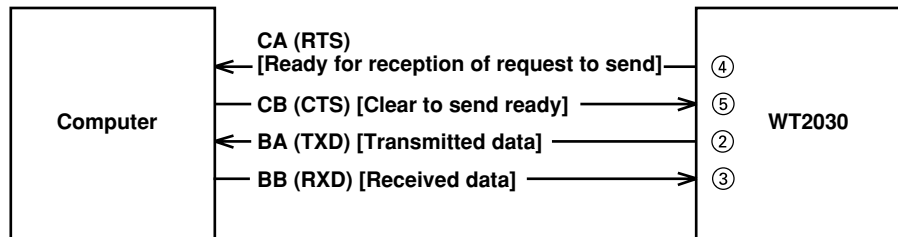

## Table of RS-232-C Standard Signals and their JIS and CCITT Abbreviations

Table

| Pin No.<br>(25-pin connector) | Abbreviations |         |                                  | Name                                 |
|-------------------------------|---------------|---------|----------------------------------|--------------------------------------|
|                               | RS-232-C      | CCITT   | JIS                              |                                      |
| ①                             | AA(GND)       | 101     | FG                               | Protective ground                    |
| ⑦                             | AB(GND)       | 102     | SG                               | Signal ground                        |
| ②                             | BA(TXD)       | 103     | SD                               | Transmitted data                     |
| ③                             | BB(RXD)       | 104     | RD                               | Received data                        |
| ④                             | CA(RTS)       | 105     | RS                               | Request to send                      |
| ⑤                             | CB(CTS)       | 106     | CS                               | Clear to send                        |
| 6                             | CC(DSR)       | 107     | DR                               | Data set ready                       |
| 20                            | CD(DTR)       | 108/2   | ER                               | Data terminal ready                  |
| 22                            | CE(RI)        | 125     | CI                               | Ring indicator                       |
| 8                             | CF(DCD)       | 109     | CD                               | Data channel received carrier detect |
| 21                            | CG(-)         | 110     | SQD                              | Data signal quality detect           |
| 23                            | CH/CI(-)      | 111     | SRS                              | Data signal rate select              |
| 24/15                         | DA/DB(TXC)    | 113/114 | ST <sub>1</sub> /ST <sub>2</sub> | Transmitter signal element timing    |
| 17                            | DD(RXC)       | 115     | RT                               | Receiver signal element timing       |
| 14                            | SBA(-)        | 118     | BSD                              | Secondary transmitted data           |
| 16                            | SBB(-)        | 119     | BRD                              | Secondary received data              |
| 19                            | SCA(-)        | 120     | BRS                              | Secondary request to send            |
| 13                            | SCB(-)        | 121     | BCS                              | Secondary clear to send              |
| 12                            | SCF(-)        | 122     | BCD                              | Secondary received carrier detect    |

\* Circles indicate pins used for the RS-232-C interface of this instrument.



## Setting Communications Mode, Handshake Mode, Data Format and Baud Rate Procedure

### Selecting the Item

Press the **LOCAL** key to display the item setting screen on display B. Pressing the  $\wedge$  or  $\vee$  key changes the item in the order of "h R n d"  $\rightarrow$  "F o r"  $\rightarrow$  "b - r R t E"  $\rightarrow$  "t E r n"  $\rightarrow$  "n o d E" and back to "h R n d".

Select the desired item, then press the **ENTER** key to confirm the selection.

### Setting the Normal/Talk-Only Mode

If "MODE" is selected and confirmed, the mode setting screen will be displayed on display D. The mode changes in the order of "n o r"  $\rightarrow$  "t o n l y"  $\rightarrow$  "4 B B 2" and back to "n o r".

Select the desired mode using the  $\wedge$ ,  $\vee$ ,  $<$  and  $>$  keys, then press the **ENTER** key.

### Setting the Handshake Mode, Data Format, Baud Rate and Sending Terminator

If "HAND" is selected and confirmed, the handshake mode setting screen will be displayed on display D. Press the  $\wedge$  or  $\vee$  key to select the desired handshake mode, then press the **ENTER** key. The format setting screen will be displayed on display D.

Set the data format, baud rate and sending terminator by the same method the handshake mode is selected.

### Setting the Output Interval (when talk-only mode is selected)

If talk-only mode is selected in the normal/talk-only mode setting screen, the output interval setting screen will be displayed on display D.

Press the  $\wedge$ ,  $\vee$ ,  $<$  or  $>$  key to set the desired interval (in units of hour, minute and second), then press the **ENTER** key.

## Description

### Setting the Mode

For details, refer to page 14-7.

### Handshaking

To use an RS-232-C interface to transfer data between this instrument and a computer, it is necessary to use certain procedures by mutual agreement to ensure the proper transfer of data. These procedures are called "handshaking." Various handshaking systems are available depending on the computer to be used; the same handshaking system must be used for both computer and this instrument.

This instrument allows you to choose any handshaking mode from the following four using the panel keys.

Handshaking System Combinations (A circle indicates that the function is available.)

| Mode selection no. | Data sending control<br>(Control method when sending data to computer)              |   |              | Data receiving control<br>(Control method when receiving data from computer)   |   |              |
|--------------------|---|---|--------------|--|---|--------------|
|                    | Software handshake  | Hardware handshake  | No handshake | Software handshake   | Hardware handshake  | No handshake |
|                    | Sending stops when X-off is received, and sending is resumed when X-on is received. | Sending stops when CB (CTS) is False, and sending is resumed when CB is True. |              | X-off is sent when received data buffer becomes 3/4-full, and X-on is sent when received data buffer becomes 1/4-full. | CA (RTS) is set to False when received data buffer becomes 3/4-full, and is set to True when received data buffer becomes 1/4-full. |              |
| 0                  |   |   | ○            |  |   | ○            |
| 1                  | ○   |   |              | ○  |   |              |
| 2                  | ○   |   |              |  | ○   |              |
| 3                  |   | ○   |              |  | ○   |              |

**Precautions Regarding Data Receiving Control**

When handshaking is used to control received data, data may still be sent from the computer even if the free space in the receive buffer drops below 64 bytes. In this case, after the receive buffer becomes full, the excess data will be lost, whether handshaking is in use or not. Data storage to the buffer will begin again when there is free space in the buffer.

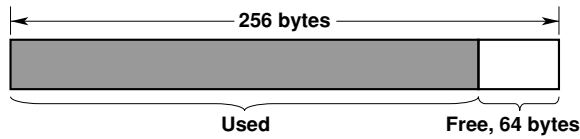

When handshaking is in use, reception of data will stop when the free space in the buffer drops to 64 bytes since data cannot be passed to the main program fast enough to keep up with the transmission.

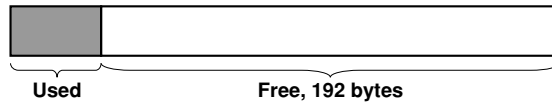

After reception of data stops, data continues to be passed to the internal program. Reception of data starts again when the free space in the buffer increases to 192 bytes.

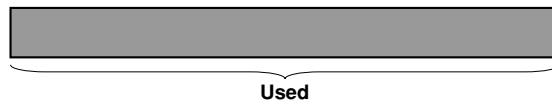

Whether handshaking is in use or not, if the buffer becomes full, any additional data received is no longer stored and is lost.

**Data Format**

The RS-232-C interface of this instrument performs communications using start-stop synchronization. In start-stop synchronization, one character is transmitted at a time. Each character consists of a start bit, data bits, a parity bit, and a stop bit. (Refer to the figure below.)

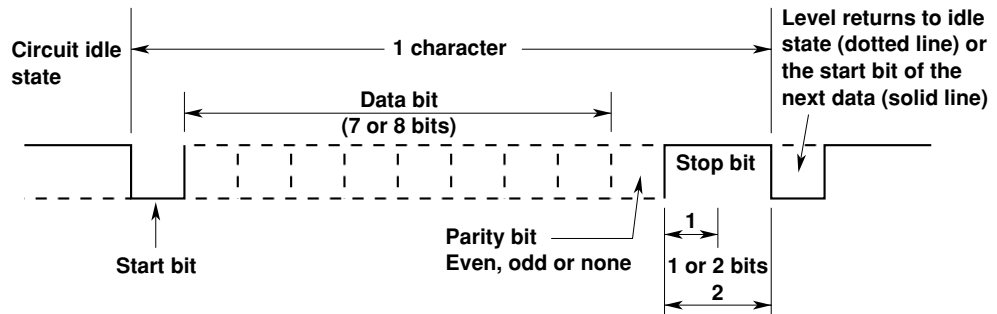

Data combinations are given below.

| Preset value | Start bit | Data length | Parity | Stop bit |
|--------------|-----------|-------------|--------|----------|
| 0            | 1         | 8           | No     | 1        |
| 1            | 1         | 7           | Odd    | 1        |
| 2            | 1         | 7           | Even   | 1        |
| 3            | 1         | 7           | No     | 2        |

### Baud Rate

The baud rate can be selected from 75, 150, 300, 600, 1200, 2400, 4800 or 9600.

### Setting the Output Interval

If talk-only mode is selected, it is necessary to set the intervals at which data is to be output.

Setting range : 00.00.00 (0 h 0 min 0 s) to 99.59.59 (99 h 59 min 59 s)

Default setting : 00.00.00

If the output interval is set to 00.00.00, data will be output at every sample rate.

### Terminator

"CR+LF" or "LF" can be used as the terminator.

The receiving terminator can be selected from "CR+LF", "LF" or "CR".

### Using an IEEE488.2-1987 Command

Select "4 8 2" in the mode setting screen. For a description of each command, refer to Appendix 2.

## Commands

The interface message function of the GP-IB interface is assigned to the following commands at the RS-232-C interface.

### <ESC>S

Equivalent to GP-IB's serial poll function. Status byte is output when the S command is received following reception of the <ESC> code (1BH).

### <ESC>R

Equivalent to GP-IB's remote/local control function. The instrument is placed in remote status and panel keys become invalid when the R command is received following reception of the <ESC> code (1BH). Press the LOCAL key to exit from the remote status.

### <ESC>L

Equivalent to GP-IB's remote/local control function. When the instrument is in remote status, the instrument will be placed in local status when the L command is received following reception of the <ESC> code (1BH).

### <ESC>C

Equivalent to GP-IB's device clear function. The communication devices of this instrument are initialized when the C command is received following reception of the <ESC> code (1BH).

### Note

- 
- Error code 390 may be displayed depending on the state of the instrument. In this case, decrease the baud rate.
-

# 15.1 Calibration and Corrective Actions in Cases where Hardware Fails

## Calibration

To maintain high measurement accuracy, the instrument should be calibrated every three months. We recommend that calibration of the instrument is not carried out by your power meter calibration facility. Calibration should always be carried out by YOKOGAWA. For details, contact YOKOGAWA or your YOKOGAWA sales representative.

## Apparent Hardware Failure - Check these Things First!

If the instrument does not operate properly even if the actions given in the table below are performed, contact YOKOGAWA or your YOKOGAWA sales representative. When contacting them, tell them the ROM version no. displayed on display B on power-up.

| Symptom   | What to Check  | Reference Pages       |
|---|--|-----------------------|
| Nothing is displayed when the power is turned ON.       | <ul style="list-style-type: none"><li>• Is the power cord securely connected to the power connector of the instrument and the AC outlet?</li><li>• Is the power voltage within the allowed range?</li><li>• Has the fuse blown?</li></ul>          | 2-4,2-5               |
| Displayed data is odd.                                  | <ul style="list-style-type: none"><li>• Are the ambient temperature and humidity within the allowed range?</li><li>• Is there noise?</li><li>• Are measurement leads connected correctly?</li><li>• Is the line filter off?</li></ul>              | 2-2,3-1, 3-2,3-4, 4-1 |
| Keys do not function.                                   | <ul style="list-style-type: none"><li>• Is the KEY LOCK indicator LED off?</li><li>• Is the REMOTE indicator LED off?</li></ul>  | 1-5,13-3, 14-5        |
| Instrument cannot be controlled via GP-IB interface.    | <ul style="list-style-type: none"><li>• Does the GP-IB address specified in the program match the address set up in the instrument?</li><li>• Does the interface meet the IEEE Standard 488-1978 electrical and mechanical requirements?</li></ul> | 14-4,14-6             |
| Instrument cannot be controlled via RS-232-C interface. | <ul style="list-style-type: none"><li>• Are the instrument and controller using the same communications settings?</li></ul>  | 14-7,14-8             |

# 15.2 Error Codes and Corrective Actions

## Error Codes for Operation and Measurement

| Error Code | Description   | Corrective Action  | Reference Pages |
|------------|---|--|-----------------|
| 11         | Received command not used by the instrument   | Check for error in the command sent.   | Appendix        |
| 12         | Parameter value specified is outside allowed range.   | Correct the value.   | —               |
| 13         | Attempt made to execute a key operation or received a communications command, while integration was running or was interrupted, that cannot be executed or received in such a state.  | Check whether integration is in progress or is interrupted.  | 8-13, Appendix  |
| 14         | Attempt made to switch to auto range mode while the external shunt range is selected.   |  |                 |
| 15         | Attempt made to execute a command or key operation that was protected.  | Check whether the command or key operation is correct.   | Appendix        |
| 16         | Attempt made to execute a key operation or received a communications command, while harmonic analysis was being performed or was interrupted, that can not be executed or received in such state.                           | Check whether harmonic analysis is in progress.  | —               |
| 17         | Stop time had passed when auto print mode is turned ON.   | Correct the stop time. The stop time must be after the current time.   | 11-8            |
| 18         | Date/time cannot be set properly.   |  | —               |
| 20         | Attempt made to execute a key operation or a communications command while flicker measurement is in progress, that cannot be executed in such a state.  |  | 10-17           |
| 21         | Attempted to start fluctuation measurement while initialization prior to fluctuation measurement is performed (i.e. while "init" is displayed on display B).  | Start fluctuation measurement after confirm the initialization is finished (i.e. display on display B goes out). | 10-3            |
| 22         | Attempted to start flicker measurement while flicker measurement is already in progress.  |  | 10-3            |
| 23         | There is no flicker output data to be printed.  |  | —               |
| 24         | Attempted to stop flicker measurement even though flicker measurement was not in progress.  |  | 10-3            |
| 25         | Attempted to switch to measurement of nominal voltage (initial state) while flicker measurement is in progress.   |  | 10-3            |
| 26         | Attempted to return to normal measurement while measurement of nominal voltage (initial state) is not in progress.  |  | 10-3            |
| 30         | No data stored in the selected set-up information file.   | Select a file in which set-up information has been stored.   | 13-1            |
| 41         | <ul style="list-style-type: none"> <li>Attempt made to start integration while there is an overflow condition.</li> <li>Attempt made to start integration after integration time has reached timer preset value.</li> </ul> | Reset integration.   | 8-11            |
| 42         | Attempt made to start integration while integration is in progress.   |  | 8-10            |
| 43         | Measurement stopped due to overflow during integration or due to a power failure.   |  | 8-11            |
| 44         | Attempt made to stop integration even though integration was not in progress.   |  | 8-11            |
| 45         | Attempt made to reset integration even though integration was not in progress or integration mode was not selected.   |  | 8-11            |
| 46         | Attempt made to start integration while measurement of peak overflow was in progress or during an overrange condition.  |  | 8-10            |
| 47         | Attempt made to start integration in continuous integration mode when integration timer preset time was set to "0".   | Set a correct preset time.   | 8-8, 8-9        |
| 48         | Attempt made to start integration in real time counting integration mode when the stop time had already passed.   | Set a correct start/stop time.   | 8-9             |
| 51         | Measurement data overflow occurred. "— □ L —" is displayed.   |  | 1-4             |
| 52         | Voltage peak overflow occurred. PEAK OVER indicator LED lights up.  |  | 1-4             |
| 53         | Current peak overflow occurred. PEAK OVER indicator LED lights up.  |  | 1-4             |
| 54         | Power factor exceeded "2" during measurement of power factor.   |  | —               |
| 55         | "P F E r r" was displayed at the end of power factor computation during measurement of phase angle.   |  | 1-4, 5-6        |
| 56         | Input level was too low or below measurement range during measurement of frequency. "E r r - L □" is displayed.   |  | 6-1             |
| 57         | Measured frequency was above the measurement range. "E r r - H," is displayed.  |  | 6-1             |
| 58         | Computation overflow occurred. "— □ F —" is displayed.  |  | 1-4, 7-8        |
| 89         | Printer's buffer memory is full.  | Make sure that the roll chart is set in place.   | 11-1            |

## Error Codes Regarding Self Diagnosis

| Error Code | Description  | Corrective Action |
|------------|--|-------------------|
| 60         | Set-up information backup data failure (Set-up information is set to factory default.) |                   |
| 61         | EPROM (input element 1) failure  | Service required. |
| 62         | EPROM (input element 2) failure  | Service required  |
| 63         | EPROM (input element 3) failure  | Service required  |
| 64         | EPROM (D/A board) failure  | Service required  |
| 65         | Sampling clock (input element 1) failure   | Service required  |
| 66         | Sampling clock (input element 2) failure   | Service required  |
| 67         | Sampling clock (input element 3) failure   | Service required  |
| 69         | Lithium battery voltage drop   | Service required  |
| 70         | Communications interface board not installed.  | Service required  |
| 71, 72     | DSP communications failure   | Service required  |
| 73         | Printer communications failure   | Service required  |
| 74         | Printer communications failure (ROM failure)   | Service required  |
| 75, 76, 77 | DSP program RAM failure  | Service required  |
| 79         | ROM checksum error   | Service required  |
| 80         | RAM read/write check error   | Service required  |
| 81, 82, 83 | DSP data RAM failure   | Service required  |
| 84, 85, 86 | DSP dual port RAM failure  | Service required  |
| 87         | Printer RAM failure  | Service required  |
| 90         | Incorrect board combination  | Service required  |

### Note

- If the instrument still does not operate properly even if the actions given above are performed, or if a self diagnostic error code is displayed, turn the power ON while holding down the **ENTER** key. In this case, the set-up information will be set to the default settings (page 2-6.)

## 15.3 Replacing the Power Supply Fuse

### Fuse Position and Replacement Method

The power supply fuse is installed inside the fuse holder located next to the power connector as illustrated below

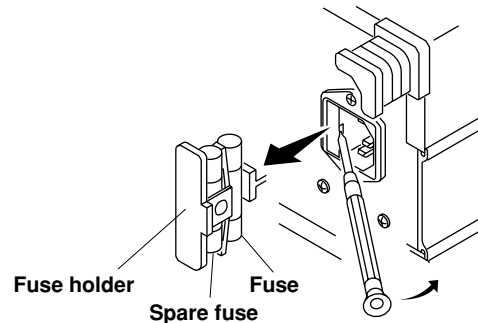

### Fuse Ratings

| Max. rated voltage | Max. rated current | Type     | Approved standard | Part No. |
|--------------------|--------------------|----------|-------------------|----------|
| 250 V              | 5 A                | Time lag | UL/VDE            | A1353EF  |



### WARNING

- The fuse used must be of the specified rating in order to prevent a fire hazard. Never use a fuse of any other rating, and never short-circuit the fuse holder to bypass the fuse.
- Do not operate the instrument if you have any reason to suspect any defect or problem with the fuse.

### Note

- The fuse inside the case can not be replaced by the user. If you believe the fuse is blown, please contact your nearest YOKOGAWA representative listed on the back cover of this manual. The ratings of the fuses used inside the case are indicated below. Instruments produced after the middle of October 1997, however, don't use fuses. For details, please contact your nearest YOKOGAWA representative listed on the back cover of this manual.

| Location            | Max. rated voltage | Max. rated current | Type     | Approved standard | Part No. |
|---------------------|--------------------|--------------------|----------|-------------------|----------|
| Voltage input board | 250 V              | 100 mA             | Time lag | UL/VDE            | A1341EF  |

### Replacing the Fuse

1. Turn the power switch OFF.
2. Disconnect the power cord from the power connector of the instrument.
3. Place the tip of a flat-blade screwdriver into the slot of the fuse holder, and move the screwdriver in the direction of the arrow to remove the fuse holder.
4. Remove the blown fuse.
5. Insert a new fuse into the holder, then install the holder in place.

---

## 15.4 Recommended Parts for Replacement

The 3-year warranty applies only to the main unit of this instrument (starting from the day of delivery) and doesn't cover any other items nor expendable items (items which wear out). In order to use the instrument over a prolonged period of time, we recommend periodic replacement. Contact your nearest Yokogawa sales representative for replacement parts. Addresses may be found on the back cover of this manual.

| <b>Parts name</b> | <b>Replacement interval</b>                               |
|-------------------|---|
| Built-in printer  | after printing 200 rolls (parts No. B9293UA) continuously |



# 16.1 Specifications

## Input

| Item  | Voltage V  | Current A   |
|---|--|---|
| Input circuit type  | Floating input   |   |
|   | Resistive voltage divider  | Shunt input   |
| Rated inputs (range rms)  | 10/15/30/60/100/150/300/600V   | Direct input<br>1/2/5/10/20/30 A<br>External shunt input:<br>50 m/100 m/200 mV  |
| Input impedance   | Input resistance<br>Approx. 2 MΩ<br>Input capacitance<br>Approx. 15 pF   | Direct input:<br>Approx. 6 mΩ + approx. 0.07 μH<br>External shunt input:<br>Approx. 100 kΩ  |
| Frequency range   | DC and 2 Hz to 500 kHz   |   |
| Instantaneous maximum allowable input for 1s  | The peak voltage is 2500 V, or the RMS value is 3 times the range, whichever is less.  | The peak current is 90 A, or the RMS value is 50 A, whichever is less.<br>External input: The peak value is 20 times the range or less. |
| Continuous maximum allowable input  | The peak voltage is 1400 V, or the RMS value is 2.5 times the range, whichever is less.  | The peak current is 60 A, or the RMS value is 35 A, whichever is less.<br>External input: The peak value is 10 times the range or less. |
| Continuous max. common mode voltage (at 50/60 Hz)   | 600 Vrms (when the protective cover for the output connector is used)CAT II,<br>400 Vrms (when the protective cover for the output connector is removed)CAT II   |   |
| Common mode rejection ratio at 600 Vrms between input terminals and case (50/60 Hz input) | Voltage input terminals shorted, current input terminals opened: Better than -80 dB (±0.01% of rdg or less)  |   |
|   | Reference value:<br>200 kHz max<br>±((0.18 x f)/(range rating))% of rdg or less<br>(Unit of f: kHz)  | Reference value:<br>200 kHz max<br>±((0.03 x f)/(range rating))% of rdg or less<br>(Unit of f: kHz)                                     |
| Input terminals   | Binding posts  | Large binding posts<br>External shunt input: BNC  |
| A/D converter   | Simultaneous conversion of voltage and current inputs<br>Resolution: 16 bits<br>Maximum conversion rate: 104 kHz   |   |
| Overload input detection  | Alarm lamp lights at approx. 350% of the input range (approx. 700% of range when crest factor is 6)  |   |
| Range switching   | The range can be switched manually, automatically, or by communication control for each element.   |   |
| Auto range switching  | Range up: When the measured value exceeds 110% of the rated value, or when the peak value exceeds 350% of the peak value<br>Range down: When the measured value becomes less than 30% of the rated value |   |
| Measurement mode switching  | The mode can be set for each element and also for each voltage and current measurement circuit.  |   |

## Display Functions

Display: 7-segment LED (light emitting diode)  
Display contents: 4 displays

| Display | Display contents  | Display resolution |
|---------|---|--------------------|
| A       | V, A, W (each element)  | V, A, W: 50000     |
| B       | V, A, W (each element)  | Wh, Ah: 500000     |
| C       | V, A, W, VA, var, PF, deg, Vpk (each element)                         | Hz: 199999         |
| D       | V, A, W, Apk, THD*, VHz, AHz<br>Wh, Ah (each element), η (efficiency) |                    |

Unit: m, k, M, V, A, W, VA, var, pk, Hz, h, deg, %  
Display update rate: Select from 0.25 sec (FAST), 0.5 sec (MID) and 2.0 sec (SLOW).  
Peak hold function: Selectable to hold item as follows

PEAK: Vpk and Apk can be held at maximum value  
ALL: Measurement value of V, A, W, VA, var, Vpk, Apk can be held at maximum value.

Response time: Maximum of twice the display update rate  
(The time taken for the display to fall within the accuracy of the final value when the filter is OFF and an abrupt change is made from 0 to 100% of the range, or from 100% to 0% of the range)

Display scaling function  
(Significant digits: Selected automatically according to the significant digits in the voltage and current range.

Setting range: 0.0001 to 10000  
Set values:

"DISPLAY A": Not displayed  
"DISPLAY B": PT ratio  
"DISPLAY C": CT ratio  
"DISPLAY D": Power scaling factor

Display averaging function  
Method: One of the following two types can be selected.  
Exponential averaging  
Moving averaging  
For exponential averaging, the attenuation Constant can be selected, and for moving averaging, the average number, N, can be set to 8, 16, 32, 64, 128 or 256.  
For harmonic mark measurements  
For exponential averaging the attenuator Constant is 5.625 when the frequency of the PLL sync source is 55 Hz or more but less than 66 Hz, and is 4.085 in other cases (when data length = 8192).

MATH function  
Method: When the DISPLAY D function is made η (efficiency), you can measure the input crest factor and also select the function that displays the results of performing arithmetic calculations (+, -, x, /) on the measurement results of DISPLAY A and B.

## Accuracy

| Item  | Voltage/current  | Power   |
|---|--|---|
| Conditions<br>Temperature<br>Humidity<br>30 to 75% RH<br>Supply voltage<br>Specified V ±5%<br>100/20A/<br>30A rang<br>Input waveform<br>Sine wave<br>In-phase<br>voltage<br>0 V<br>Power factor<br>Cos φ = 1<br>Line filter<br>OFF<br>Crest factor<br>3<br>Scaling<br>OFF<br>6-month<br>accuracy<br>The unit of f in<br>the accuracy<br>calculation<br>formula is kHz | Temperature<br>23 ± 3°C<br>except<br>600V,<br>100/20A/<br>30A rang   | 45Hz ≤ f ≤ 66Hz<br>± (0.03% of rdg + 0.03% of<br>rng)   |
|   | Temperature<br>23 ± 5°C  | DC:<br>± (0.04% of rdg + 0.08% of mg)<br>2Hz ≤ f < 30Hz<br>± (0.1% of rdg + 0.2% of mg)<br>30Hz ≤ f ≤ 1kHz<br>± (0.03% of rdg + 0.05% of mg)<br>1kHz < f ≤ 10kHz<br>± (0.02 X f% of rdg + 0.1% of mg)<br>10kHz < f ≤ 50kHz<br>± [0.018 X (f-10)% of<br>rdg + 0.3% of mg]<br>50kHz < f ≤ 100kHz<br>± [0.03 X (f-50)% of<br>rdg + 1.0% of mg]<br>100kHz < f ≤ 500kHz<br>± [0.035 X (f-100)% of<br>rdg + 2.5% of mg]<br>2 Hz ≤ f < 10 Hz and<br>more than 200 kHz is the<br>design value.<br>If the display update rate is<br>10 Hz or more -> MID<br>If the display update is 2<br>Hz or more -> SLOW |
| Effect of power factor<br>The φ is the phase angle<br>between the voltage and<br>current, and the f is the<br>frequency.  | -  | When cosφ = 0 : add ±0.1%<br>of mg to 45Hz ≤ f ≤ 66Hz,<br>add ±0.15% of mg to 66Hz<br>< f ≤ 440Hz.<br>As reference data, add<br>±(0.15 + 0.15 X f kHz)% of<br>mg, up to 300kHz max.<br>When 1 > cosφ > 0 : add<br>the product of tanφ and the<br>effect on cosφ = 0.  |
| Effective input range   | Between 10 and 110% of the rated input value<br>(The accuracy when the input is between 110 and<br>130% is 1.5 times the read value error.)  |   |
| Accuracy of crest factor of 6   | 1.5 times the range error of a crest factor of 3<br>(accuracy when the above temperature is 23 ± 5°C)  |   |
| Temperature coefficient   | ± 0.02% of rdg/°C between 5 and 18°C and between<br>28 and 40°C  |   |
| Data update rate  | 0.25s, 0.5s, 2.0s  |   |
| Line filter function  | Measurement can be performed with low pass filters<br>inserted into the input circuit and the frequency<br>measurement circuit.<br>A cutoff frequency (fc) can be selected from 500 Hz<br>and 5.5 kHz. |   |
| Accuracy when the line filter<br>is ON  | For fc/10 or less: Add ±1%<br>of mg to the accuracy when<br>the filter is OFF.   | For fc/10 or less: Add ±2% of<br>mg to the accuracy when the<br>filter is OFF.  |
| One year's accuracy   | Read value error (6 months' accuracy) + Range error<br>(6 months' accuracy) x 1.5<br>Calibration period is one year.   |   |
| Detection accuracy of<br>leading phase/lagging phase  | ±5 deg (20 Hz to 10 kHz) for sinusoidal voltage and current<br>inputs, crest factor of 3, and at least 50% of range rating   |   |
| Measurement lower limit<br>frequency  | Display update rate; Measurement lower limit<br>frequency<br>250 ms 20 Hz or higher<br>500 ms 10 Hz or higher<br>2 sec 2 Hz or higher  |   |

## Frequency Measurement Function

Measurement input: V1, V2, V3, A1, A2, A3  
Measurement method: Reciprocal method  
Measurement frequency range:

Depends upon the display update rate as shown below (auto  
range).  
250ms: 2 k/20 k/200 k/1000 kHz  
500ms: 200/2 k/20 k/200 k/500 kHz  
25: 20/200/2 k/20 k/100 kHz

Maximum display: 199999  
250ms: 18.00 Hz  
500ms: 9.000 Hz  
25: 18000 Hz

Accuracy: ±0.05% of rdg  
• When the voltage and current are both at least 30% of the range  
rating  
• When the crest factor is 3 and the frequency is at least 20% of  
the minimum frequency range  
• For 200 Hz or less, when the filter is ON

## 16.1 Specifications

### Computing Functions

|   | Active Power (W)   | Apparent power (VA)                                | Reactive power (var)   | Power factor (PF)                        | Phase angle (deg)   |
|---|--|--|--|--|---|
| Single phase, 2-wire  | W  | VA = V × A   | $\sqrt{(VA)^2 - W^2}$  | $\frac{W}{VA}$                           | $\cos^{-1}\left(\frac{W}{VA}\right)$                                |
| Single phase 3-wire   | $W_i$<br>i = 1, 3  | $VA_i = V_i \times A_i$<br>i = 1, 3                | $\text{var}_i = \sqrt{(VA_i)^2 - W_i^2}$<br>i = 1, 3           | $PF_i = \frac{W_i}{VA_i}$<br>i = 1, 3    | $\varphi_i = \cos^{-1}\left(\frac{W_i}{VA_i}\right)$<br>i = 1, 3    |
|   | $\sum W = W_1 + W_3$   | $\sum VA = VA_1 + VA_3$                            | $\sum \text{var} = \text{var}_1 + \text{var}_3$                | $\sum PF = \frac{\sum W}{\sum VA}$       | $\sum \varphi = \cos^{-1}\left(\frac{\sum W}{\sum VA}\right)$       |
| 3-phase 3-wire (2 voltages, 2 currents)   | $W_i$<br>i = 1, 3  | $VA_i = V_i \times A_i$<br>i = 1, 3                | $\text{var}_i = \sqrt{(VA_i)^2 - W_i^2}$<br>i = 1, 3           | $PF_i = \frac{W_i}{VA_i}$<br>i = 1, 3    | $\varphi_i = \cos^{-1}\left(\frac{W_i}{VA_i}\right)$<br>i = 1, 3    |
|   | $\sum W = W_1 + W_3$   | $\sum VA = \frac{\sqrt{3}}{2}(VA_1 + VA_3)$        | $\sum \text{var} = \text{var}_1 + \text{var}_3$                | $\sum PF = \frac{\sum W}{\sum VA}$       | $\sum \varphi = \cos^{-1}\left(\frac{\sum W}{\sum VA}\right)$       |
| 3-phase 3-wire (3 voltages, 3 currents)   | $W_i$<br>i = 1, 2, 3<br>(W2 does not have a physical meaning.) | $VA_i = V_i \times A_i$<br>i = 1, 2, 3             | $\text{var}_i = \sqrt{(VA_i)^2 - W_i^2}$<br>i = 1, 2, 3        | $PF_i = \frac{W_i}{VA_i}$<br>i = 1, 2, 3 | $\varphi_i = \cos^{-1}\left(\frac{W_i}{VA_i}\right)$<br>i = 1, 2, 3 |
|   | $\sum W = W_1 + W_2 + W_3$                                     | $\sum VA = \frac{\sqrt{3}}{3}(VA_1 + VA_2 + VA_3)$ | $\sum \text{var} = \text{var}_1 + \text{var}_2 + \text{var}_3$ | $\sum PF = \frac{\sum W}{\sum VA}$       | $\sum \varphi = \cos^{-1}\left(\frac{\sum W}{\sum VA}\right)$       |
| 3-phase 4-wire  | $W_i$<br>i = 1, 2, 3   | $VA_i = V_i \times A_i$<br>i = 1, 2, 3             | $\text{var}_i = \sqrt{(VA_i)^2 - W_i^2}$<br>i = 1, 2, 3        | $PF_i = \frac{W_i}{VA_i}$<br>i = 1, 2, 3 | $\varphi_i = \cos^{-1}\left(\frac{W_i}{VA_i}\right)$<br>i = 1, 2, 3 |
|   | $\sum W = W_1 + W_2 + W_3$                                     | $\sum VA = VA_1 + VA_2 + VA_3$                     | $\sum \text{var} = \text{var}_1 + \text{var}_2 + \text{var}_3$ | $\sum PF = \frac{\sum W}{\sum VA}$       | $\sum \varphi = \cos^{-1}\left(\frac{\sum W}{\sum VA}\right)$       |
| Calculation range   | The rated value depends upon the V and A ranges.               | The rated value depends upon the V and A ranges.   | Same as the apparent power (var > 0)                           | -1-0-1                                   | LEAD 180-0<br>LAG 180 or 0-360                                      |
| Maximum display resolution  | 50000  | 50000  | 50000  | ±1.0000                                  | 0.01  |
| Calculation accuracy (with respect to the calculation value from the measurement value) | —  | ±0.001% of the rated value (VA)                    | ±0.001% of the rated value (VA)                                | ±0.0001                                  | ±0.005° with respect to the calculation from the                    |

- Note 1: The apparent power (VA), reactive power (var), power factor (PF), and phase angle (deg) measurement in this instrument are computed digitally from the voltage, current and active power. If the input is non-sinusoidal, the measured values may differ from those obtained with instruments employing different measurement principles.
- Note 2: When the Current or Voltage value is less than 0.3% of range, the VA and var will be displayed 0, and PF/deg will be displayed as Error.
- Note 3: Regarding the detected accuracy of the Lead and Lag, both voltage and current of the rated input are specified at 50% or more for sinusoidal waveforms set at crest factor 3. The detected Lead/Lag accuracy is ±5 degree over the frequency range 20 Hz to 10 kHz.
- Note 4: When the phase angle display shows an angle smaller than 5 degree at 0° and 180°, the accuracy is not specified.
- Note 5: If the scaling values set for each element differ from each other in the case of  $\sum$  computation, the number of display digits will be limited so that  $\sum$  value does not exceed 30000 (crest factor 3) of 10000 (crest factor 6) when the rated value is input to each corresponding element. A voltage of 5 V (full scale) will be output from the D/A converter as the  $\sum$  value obtained when the rated value is input to each corresponding element.
- Note 6: In a  $\sum$  var calculation, the var value of each phase is calculated as a negatively signed value when the phase of the current input is advanced with respect to the voltage input, and is calculated as a positively signed value when the phase is lagging.

### Integration Functions

|                     |  |
|---------------------|--|
| Maximum display:    | 500000   |
| Frequency range:    | According to the displayed value, the resolution will be changed. DC to 50 kHz   |
| Modes:              | Standard Integration Mode (timer mode)<br>Continuous Integration Mode (repeat mode)<br>Manual Integration Mode   |
| Timer:              | When the timer is set, integration will be stopped automatically.<br>Setting range : 000 h: 00min to 999 h: 59 min<br>(000 h: 00min will be shown when integration mode is selected.)                          |
| Display:            | manual<br>Display A shows : Elapsed time<br>Display B/C shows : Watt<br>Display D shows : Watt, Wh, Ah, Hz   |
| Output:             | For the output of the printer, communication and D/A, fourteen free selectable items from the above can be set. However, only the measured data of the frequency which has been previously set will be output. |
| Count Overflow:     | If integration count overflows the maximum displayable value, integration stops and the elapsed time is held on the display.   |
| Real Time Counting: | The integration time can be controlled REAL TIME.  |
| Accuracy:           | ±(display accuracy + 0.05% of rdg)   |
| Timer accuracy:     | ±0.005%  |
| Remote Control:     | Start, stop and reset can be remotely controlled by external contact signals.  |

### Communication Functions

|   |  |
|---|--|
| Communication Specifications (GP-IB & RS-232-C) |  |
| GP-IB   | Electrical and mechanical specifications:<br>IEEE Std 488-1978 (JIS C 1901-1987)<br>Functional specifications: SH1, AH1, T5, L4, SR1, RL1, PR0, DC1, DT1, C0<br>Protocol: IEEE Std 488.2-1987<br>Code used: ISO (ASCII) code<br>Address: 0 to 30 talker/listener addresses can be set. |
| RS-232-C  | Start Stop Synchronization   |
| Transmission mode:                              | 75, 150, 300, 600, 1200, 2400, 4800, 9600 bps  |
| Baud Rate:                                      |  |

### External Control

|         |   |
|---------|---|
| Signal: | EXT-HOLD, EXT-TRIG, EXT-PRINT, EXT-START, EXT-STOP, EXT-RESET, INTEG-BUSY, FLICKER-BUSY |
| Input:  | TTL level negative pulses   |

### Printer (optional)

|  |   |
|--|---|
| Contents of printing                         | For normal measurement:<br>Printing of numerical values - All items<br>(Can be set freely, however is set in common with the communication output.)   |
| For harmonic analysis function (optional):   | Printing of numerical values - V, A, W, VA, var, PF, deg<br>Bar graphs - V, A, W, deg   |
| For flicker measurement function (optional): | At end of 1 observation period - dc, dmax, d(t) 200 ms, Pst and evaluation criteria, evaluation results and total accuracy function (CPF) graph for each parameter<br>At end of all observation periods - Plt, Overall evaluation |
| Printing method:                             | Thermal line dot printing   |

### D/A Output (optional)

|                          |  |
|--------------------------|--|
| Number of outputs:       | 14 items (can be set for each channel)                         |
| Resolution:              | 12 bits  |
| Accuracy:                | ±(display accuracy + 0.2% of rng)                              |
| Output voltage:          | ±5 V FS with respect to each rated value (max. approx. ±7.5 V) |
| Maximum output current:  | ±1 mA  |
| Temperature coefficient: | ±0.05% of rng/°C   |
| Update rate:             | Same as update rate of main unit                               |

### Harmonic analysis function (optional)

|  |  |
|--|--|
| Type:                                      | PLL sync method  |
| Measurement frequency:                     | The fundamental frequency range is 10 Hz to 440 Hz.  |
| Display resolution:                        | 50000  |
| Harmonics to be measured:                  | Steady-state and fluctuating harmonics   |
| Analysis items:                            | Each harmonic level of V, A, W and deg, RMS voltage, RMS current, active power, VA, var, PF and deg of fundamental wave, SV, SA, SW harmonic distortion, each harmonic content, fundamental wave voltage, current, phase angle, phase angle between each harmonic and the fundamental wave |
| Sampling rate/window width/analysis order: | Depends on the input frequency as follows when the PLL sync method is used.  |

| Fundamental frequency | Sampling frequency [Hz] | Window width with respect to FFT data length (number fundamental) |      |      |      |     | Maximum analysis order |
|-----------------------|-------------------------|---|------|------|------|-----|------------------------|
|                       |                         | 8192  | 4096 | 2048 | 1024 | 512 |                        |
| 10 ≤ f < 20           | f × 2048                | 4   | 2    | 1    | -    | -   | 50(50)                 |
| 20 ≤ f < 40           | f × 1024                | 8   | 4    | 2    | 1    | -   | 50(50)                 |
| 40 ≤ f < 70           | f × 512                 | 16  | 8    | 4    | 2    | 1   | 50(50)                 |
| 70 ≤ f < 130          | f × 256                 | 32  | 16   | 8    | 4    | 2   | 50(25)                 |
| 130 ≤ f < 250         | f × 128                 | 64  | 32   | 16   | 8    | 4   | 50(13)                 |
| 250 ≤ f ≤ 440         | f × 64                  | 128   | 64   | 32   | 16   | 8   | 25(9)                  |

|                             |   |
|-----------------------------|---|
| FFT processing word length: | 32 bits   |
| Window function:            | Rectangular   |
| Data acquisition operation: | Continuously, no dead time  |
| Averaging:                  | Exponential average for time constant of 1.5 seconds (when the fundamental frequency is 50/60 Hz)   |
| Display update period:      | 250 ms/500 ms/2 s   |
| Anti-aliasing filter:       | At fundamental frequency of 50/60 Hz, the aliasing up to the 40th analysis order is -50 dB or better (when the line filter is ON and the cutoff frequency is 5.5 kHz).  |
| Accuracy:                   | As follows when the crest factor = 3<br>When the anti-aliasing filter is ON<br>Voltage/current Active power Phase angle<br>10 Hz ≤ f < 40 Hz 10 Hz ≤ f < 40 Hz 10 Hz ≤ f < 40 Hz<br>±(1% of rdg + 0.3% of rng) ±(3% of rdg + 0.5% of rng) ±15deg<br>40 Hz ≤ f ≤ 500 Hz 40 Hz ≤ f ≤ 500 Hz 40 Hz ≤ f ≤ 2.5 kHz<br>±(1% of rdg + 0.05% of range) ±(2% of rdg + 0.01% of range) ±10deg<br>500 Hz < f ≤ 2.5 kHz COS=1 2.5 kHz < f ≤ 3.5 kHz<br>±(2% of rdg + 0.05% of range) ±15deg<br>2.5 kHz < f ≤ 3.5 kHz<br>±(5% of rdg + 0.2% of range)<br>When the anti-aliasing filter is OFF<br>Same as for normal measurement (however, the specification is satisfied when the instrument is operated in 23±5°C.)<br>• The above accuracy is stipulated when the input for each analysis order is no more than 110% of the rated value.<br>• If the input range exceeds 110%, add range error × 2.<br>• When the crest factor is 6, add range error × 1 to the above crest factor = 3 accuracy.<br>• The input range is the range in which the "peak overload display LED" does not light.<br>• (within about ±350% of the measurement range)<br>• However, it must be within the maximum allowable input range.<br>• When the data length = 1024 or the fundamental frequency is less than 40 Hz, add range error × 3. |

## Flicker measurement (optional)

|                            |  |
|----------------------------|--|
| Measurement items:         | dc Relative steady-state voltage change<br>dmax Maximum relative voltage change<br>$d(t)_{200ms}$ Term within the voltage change during which the threshold level is exceeded<br>Regarding the above items, the maximum value is displayed within 1 observation term<br>Pst Short-term flicker indicator<br>Plt Long-term flicker indicator  |
| Flicker scale:             | 0.01 to 6400 PU (20%) is divided logarithmically into 1024 parts.  |
| 1 observation term:        | 30 seconds to 15 minutes<br>Number of observation term: 1 to 99  |
| Display update:            | 2 seconds (dc, dmax, $d(t)_{200ms}$ )<br>At the end of each observation (Pst)  |
| Steady-state condition:    | The relative voltage change can be set between 0.10 and 9.99% (0.01% steps).   |
| Printer output:            | See the printer item.  |
| Accuracy:                  | Half-wave RMS value: $\pm 0.1\%$ of rdg $+0.1\%$ of rng<br>(45 Hz $\leq f \leq 66$ Hz)   |
| dc, dmax, $d(t)_{200ms}$ : | In accordance with IEC1000-3-3.  |
| Pst, Plt:                  | $\pm 5\%$ when Pst = 1<br>The above accuracy applies to the following conditions. <ul style="list-style-type: none"> <li>• After warm-up of at least 2 hours.</li> <li>• Subsequent ambient temperature change is no more than <math>\pm 1^\circ\text{C}</math>.</li> <li>• The input voltage is 50% to 110% of the range rating.</li> </ul> |

## General specifications

| Working temperature range:            | 5 to 40°C   |             |                         |           |       |             |             |       |              |             |       |              |             |       |              |             |
|---------------------------------------|---|-------------|-------------------------|-----------|-------|-------------|-------------|-------|--------------|-------------|-------|--------------|-------------|-------|--------------|-------------|
| Storage temperature:                  | -25 to 60°C   |             |                         |           |       |             |             |       |              |             |       |              |             |       |              |             |
| Working humidity range:               | 20 to 80% RH (no condensation)  |             |                         |           |       |             |             |       |              |             |       |              |             |       |              |             |
| Operating altitude:                   | 2000 m or below   |             |                         |           |       |             |             |       |              |             |       |              |             |       |              |             |
| Warmup time:                          | Approx. 30 minutes  |             |                         |           |       |             |             |       |              |             |       |              |             |       |              |             |
| Insulation resistance:                | At least 50 MW at 500 V DC<br>(between each input terminal and case, between each input terminal, between each input terminal and power plug, between case and power plug)  |             |                         |           |       |             |             |       |              |             |       |              |             |       |              |             |
| Withstand voltage:                    | 3700 VAC 50/60 Hz for one minute<br>(between each input terminal, between each input terminal and power plug)<br>2200 VAC 50/60 Hz for one minute<br>(between each input terminal and case)<br>1500 VAC 50/60 Hz for one minute<br>(between case and power plug)  |             |                         |           |       |             |             |       |              |             |       |              |             |       |              |             |
| Power supply:                         | <table> <thead> <tr> <th>Setting</th> <th>Allowable Voltage range</th> <th>Frequency</th> </tr> </thead> <tbody> <tr> <td>100 V</td> <td>90 to 110 V</td> <td>48 to 63 Hz</td> </tr> <tr> <td>115 V</td> <td>100 to 132 V</td> <td>48 to 63 Hz</td> </tr> <tr> <td>200 V</td> <td>180 to 220 V</td> <td>48 to 63 Hz</td> </tr> <tr> <td>230 V</td> <td>198 to 284 V</td> <td>48 to 63 Hz</td> </tr> </tbody> </table>   | Setting     | Allowable Voltage range | Frequency | 100 V | 90 to 110 V | 48 to 63 Hz | 115 V | 100 to 132 V | 48 to 63 Hz | 200 V | 180 to 220 V | 48 to 63 Hz | 230 V | 198 to 284 V | 48 to 63 Hz |
| Setting                               | Allowable Voltage range   | Frequency   |                         |           |       |             |             |       |              |             |       |              |             |       |              |             |
| 100 V                                 | 90 to 110 V   | 48 to 63 Hz |                         |           |       |             |             |       |              |             |       |              |             |       |              |             |
| 115 V                                 | 100 to 132 V  | 48 to 63 Hz |                         |           |       |             |             |       |              |             |       |              |             |       |              |             |
| 200 V                                 | 180 to 220 V  | 48 to 63 Hz |                         |           |       |             |             |       |              |             |       |              |             |       |              |             |
| 230 V                                 | 198 to 284 V  | 48 to 63 Hz |                         |           |       |             |             |       |              |             |       |              |             |       |              |             |
| Power consumption:                    | 120 VA max.   |             |                         |           |       |             |             |       |              |             |       |              |             |       |              |             |
| Accuracy of internal clock:           | Approx $\pm 30$ seconds in one month  |             |                         |           |       |             |             |       |              |             |       |              |             |       |              |             |
| Vibration conditions:                 | Sweep test 2-way sweep from 8 to 150 Hz in all 3 directions for 1 minute each<br>Durability test Frequency 16.7 Hz, amplitude of 4 mm in all 3 directions for 2 hours each  |             |                         |           |       |             |             |       |              |             |       |              |             |       |              |             |
| Impact conditions:                    | Impact test Acceleration 490 m/s <sup>2</sup> , in all 3 directions<br>Durability test Free-fall test Height 100 mm, once on each of 4 sides  |             |                         |           |       |             |             |       |              |             |       |              |             |       |              |             |
| External dimensions:                  | Approx. 426 (W) x 132 (H) x 400 (D) mm  |             |                         |           |       |             |             |       |              |             |       |              |             |       |              |             |
| Weight:                               | Approx. 13 kg   |             |                         |           |       |             |             |       |              |             |       |              |             |       |              |             |
| Accessories:                          | Power cord: UL/CSA, VDE, SAA or BS standard x 1 pcs.  |             |                         |           |       |             |             |       |              |             |       |              |             |       |              |             |
| Fuse:                                 | 2 pcs, including a spare one  |             |                         |           |       |             |             |       |              |             |       |              |             |       |              |             |
| Remote control connector:             | A1005JD x one   |             |                         |           |       |             |             |       |              |             |       |              |             |       |              |             |
| External shunt input connector cable: | B9384LK One for each element<br>Printer paper (when /B5 is added): B9293UA 2 rolls<br>rubber of back foot   |             |                         |           |       |             |             |       |              |             |       |              |             |       |              |             |
| Emission*                             | Complying Standard: EN55011-Group1, ClassA<br>This is a Class A product for industrial environment. In a domestic environment, this product may cause radio interference in which cause the user may be required to take adequate measures.<br>Cable Condition:<br>Measuring Input<br>To bundle the wires between source and load for each phase and to separate the input signal wires by less than 50mm between each phase and neutral line.<br>External Input<br>To use shielded wires |             |                         |           |       |             |             |       |              |             |       |              |             |       |              |             |
| Immunity*                             | Complying Standard: EN50082-2:1995<br>Susceptibility Under Immunity Condition<br>Measuring Input : $\pm 10\%$ of range max<br>DA Output : $\pm 40\%$ of range max<br>Testing Condition<br>Voltage : range 100V Input, 100V/50Hz<br>Current : range 1A Input, 1A/50Hz  |             |                         |           |       |             |             |       |              |             |       |              |             |       |              |             |
| Safety standard*                      | Complying Standard : EN61010<br>Overvoltage Category II<br>Pollution degree 2   |             |                         |           |       |             |             |       |              |             |       |              |             |       |              |             |

\* Applies to products manufactured after Jan. 1997 having the CE Mark. For all other products, please contact your nearest YOKOGAWA representative as listed on the back cover of this manual.

## 16.2 External Dimensions

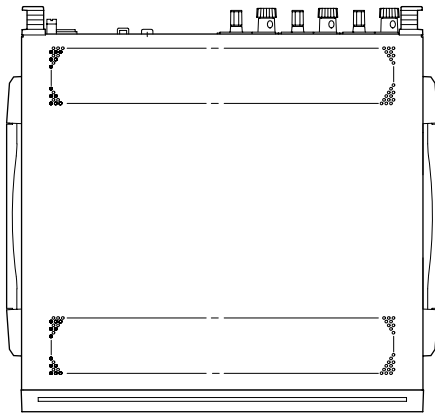

Rear View

unit: mm

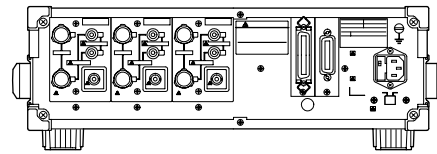

253103

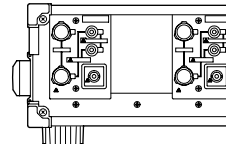

253102

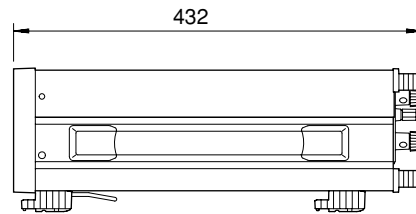
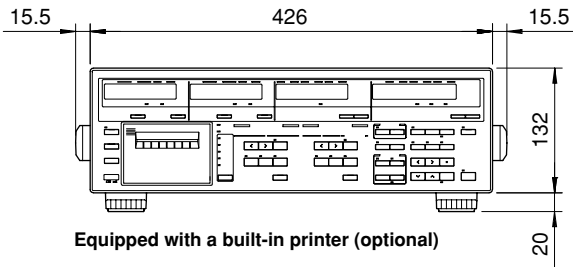

• Rack Mount (JIS)

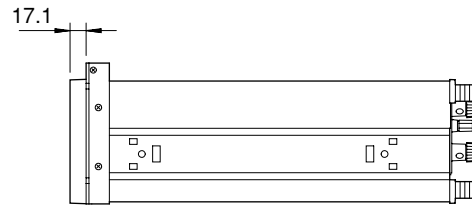
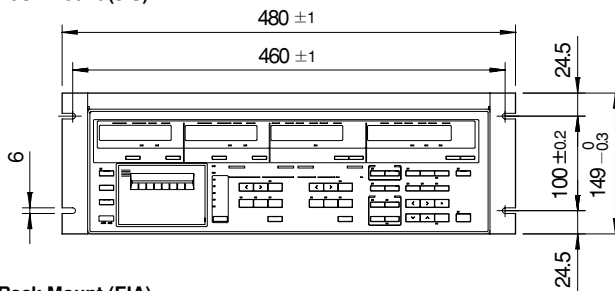

• Rack Mount (EIA)

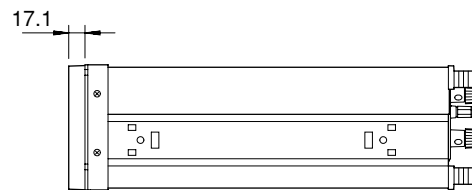
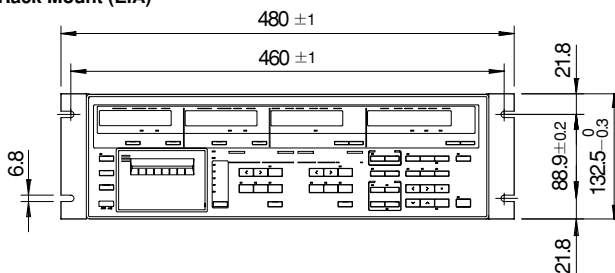

Unless otherwise specified, tolerance is  $\pm 3\%$ . (However, tolerance is  $\pm 0.3$  mm when below 10 mm.)

## Appendix 1.1 List of Communications Commands

For detailed description of each command, refer to the Appendix 1.2.

|                         | Command   | Action  |
|-------------------------|---|---|
| Wiring system           | WR m (WiRing)   | Sets wiring system.   |
| Voltage range           | RV m1,m2 (Range Voltage)  | Sets voltage range.   |
| Current range           | AV m1,m2 (Auto Voltage range)                                   | Sets voltage auto range.  |
|                         | RA m1,m2 (Range current(A))                                     | Sets current range.   |
|                         | AA m1,m2 (Auto current(A) range)                                | Sets current auto range.  |
| Measurement mode        | SA m1,m2 (Shunt Ampere)   | Sets external shunt current value.                              |
|                         | MV m1,m2 (rms/Mean/dc Voltage)                                  | Sets RMS/MEAN/DC mode for voltage measurement.                  |
| Peak hold               | MA m1,m2 (rms/Mean/dc current(A))                               | Sets RMS/MEAN/DC mode for current measurement.                  |
|                         | KH m (peaK Hold)  | Sets peak hold ON or OFF.                                       |
| Frequency filter        | KF m (peaK hold Function)                                       | Sets the peak hold function.                                    |
|                         | QF m1,m2 (freQuency Filter)                                     | Sets source for which frequency measurement is to be performed. |
| Line filter             | FL m (Filter)   | Sets line filter ON or OFF.                                     |
|                         | FC m (FiLter Cut off frequency)                                 | Sets cut-off frequency.   |
| Crest factor            | CF m (Crest Factor)   | Sets crest factor 3 or 6.                                       |
| NULL function           | NL m (NuLl function)  | Sets the NULL function.   |
| Display update interval | SI m (Sampling Interval)  | Sets sample rate.   |
| Hold                    | HD m (sampling Hold)  | Holds display and output data.                                  |
| Trigger                 | E or ST or <GET>  | Trigger   |
| Display                 | DA m (Display A function)                                       | Selects function to be displayed on display A.                  |
|                         | DB m (Display B function)                                       | Selects function to be displayed on display B.                  |
|                         | DC m (Display C function)                                       | Selects function to be displayed on display C.                  |
|                         | DD m (Display D function)                                       | Selects function to be displayed on display D.                  |
|                         | EA m (Element display A)  | Selects element to be displayed on display A.                   |
|                         | EB m (Element display B)  | Selects element to be displayed on display B.                   |
|                         | EC m (Element display C)  | Selects element to be displayed on display C.                   |
|                         | ED m (Element display D)  | Selects element to be displayed on display D.                   |
| Phase angle display     | DG m (DeGree)   | Sets phase angle display format.                                |
| Scaling                 | SC m (SCaling)  | Sets scaling function ON or OFF.                                |
|                         | KV m1,m2 (K*Voltage)  | Sets scaling constant.  |
|                         | KA m1,m2 (K*Ampere)   | Sets scaling constant.  |
|                         | KWm1,m2 (K*Wattage)   | Sets scaling constant.  |
| Averaging               | AG m (AveraGing)  | Sets averaging function ON or OFF.                              |
|                         | AT m (Averaging Type)   | Selects exponential averaging or moving averaging.              |
| MATH                    | AC m (Averaging Coefficient)                                    | Sets attenuation constant or averaging number.                  |
|                         | MT m (MaThematics)  | Sets computing equation.  |
| Integration             | IS (Integrate Start)  | Starts integration.   |
|                         | IP (Integrate stoP)   | Stops integration.  |
|                         | IR (Integrate Reset)  | Resets integrated value.  |
|                         | IC m (Integrate Continuous)                                     | Sets integration mode.  |
|                         | TM m1,m2 (integrate TiMer)                                      | Sets integration timer preset time.                             |
|                         | IT m1/m2/m3/m4/m5/m6,m7/m8/m9/m10/m11/m12 (Integrate real Time) | Sets integration start time and stop time.                      |
|                         | IL m (Integrate poLarity)                                       | Sets integration polarity.                                      |
| Other                   | DT m1,m2,m3 (DaTe)  | Sets date.  |
|                         | TI m1,m2,m3 (TIme)  | Sets time.  |
| Set-up information      | SL m (panel Setting Load)                                       | Recall set-up information.                                      |
|                         | SS m (panel Setting Save)                                       | Store set-up information.                                       |
|                         | RC (Reset Command)  | Initializes set-up information.                                 |
| Communications          | CM m (Communication coMmand)                                    | Sets command group to be used.                                  |
|                         | OD (Output Data)  | Requests output of measured data.                               |
|                         | OF m1,m2 (Output Function)                                      | Sets output items.  |
|                         | OFD m (Output Function Default)                                 | Sets default output items.                                      |
|                         | OS (Output panel Setting)                                       | Requests output of set-up information.                          |
|                         | OE (Output Error code)  | Requests output of error code.                                  |
|                         | H m (Header)  | Sets header for measured data.                                  |
|                         | TO m (Type of Output data)                                      | Sets type of output format.                                     |
|                         | DL m (DeLimiter)  | Selects output data delimiter.                                  |
| IM m (Interrupt Mask)   | Sets status byte interrupt cause mask.                          |   |

### Note

- If commands relating to options are used on instruments which do not have the options installed, "Error 11" is displayed. Also, there are no responses to inquiries.
- For the ESC commands of the RS-232-C interface, refer to page 14-12.

Optional Commands

|                                    | Command  | Action  |
|------------------------------------|--|---|
| Harmonic analysis                  | HA m (Harmonics Analyze)   | Sets harmonic analysis ON or OFF.   |
|                                    | HO m (Harmonics Order)   | Sets maximum order.   |
|                                    | PS m (PLL Source)  | Sets PLL source.  |
|                                    | AF m (Anti-aliasing Filter)  | Sets anti-aliasing filter ON or OFF.  |
|                                    | DH m (Display for Harmonics)   | Sets display format for harmonic analysis.  |
|                                    | DF m (Distortion Formula)  | Sets distortion equation  |
|                                    | HW m (Harmonics Window width)  | Sets the window width for harmonic analysis.  |
|                                    | OR m (harmonics ORder)   | Sets order of harmonic to be displayed.   |
|                                    | OH m1,m2<br>(Output Harmonic function)                                       | Sets output items for harmonic analysis.  |
|                                    | OHD m<br>(Output Harmonics Default)  | Sets output items to default settings for harmonic analysis.  |
| Printer                            | PO (Print Out)   | Requests print out.   |
|                                    | FD m (paper FeeD)  | Requests paper feed.  |
|                                    | AB (print ABort)   | Requests print abort.   |
|                                    | PR m (PRinter)   | Sets auto print mode ON or OFF.   |
|                                    | PY m (Print sYnchronous mode)  | Sets print synchronous method.  |
|                                    | PI m1,m2,m3 (Print Interval)   | Sets print interval for auto print.   |
|                                    | PT m1/m2/m3/m4/m5/m6, m7/m8/m9/m10/m11/m12<br>(Print real Time)              | Sets auto print START/STOP time.  |
|                                    | PF m1,m2 (Print Function)  | Sets print items for normal measurement.  |
|                                    | PFD m (Print Function Default)   | Sets print items to default settings for normal measurement.  |
|                                    | PH m1,m2 (Print Harmonics)   | Sets print items for harmonic analysis.   |
|                                    | PHD m (Print Harmonics Default)  | Sets print items to default settings for harmonic analysis.   |
|                                    | PK m1,m2 (Print flicker)   | Sets print items for flicker measurement.   |
|                                    | PKD (Print flicker Default)  | Sets print items to default settings for flicker measurement.   |
|                                    | PP (Print Panel setting)   | Prints out set-up information.  |
| /DA                                | OA m1,m2,m3 (Output Analog)  | Sets D/A output items for normal measurement.   |
|                                    | OAD m (Output Analog Default)  | Sets D/A output items to default settings for normal measurement.   |
|                                    | AH m1,m2,m3,m4<br>(Analog Harmonics)   | Sets D/A output items for harmonic analysis.  |
|                                    | AHD m<br>(Analog Harmonics Default)  | Sets D/A output items to default settings for harmonic analysis.  |
|                                    | RT m1,m2 (integrate Rated Time)  | Sets rated time for integration.  |
| Flicker                            | FK m (Flicker)   | Sets flicker measurement ON or OFF.   |
|                                    | FS (Flicker Start)   | Starts measurement of voltage fluctuation.  |
|                                    | FP (Flicker stoP)  | Stops measurement of voltage fluctuation.   |
|                                    | FN (Flicker iNitial)   | Resets measurement of voltage fluctuation.  |
|                                    | FDA m (Flicker Display A function)   | Function to be displayed during flicker measurement   |
|                                    | FEA m (Flicker Element display A)  | Element to be displayed during flicker measurement  |
|                                    | FNO m (Flicker period NO.)   | Sets the flicker observation period no. for flicker measurement.  |
|                                    | UNO m (UN setting mOde)  | Sets the acquisition method for nominal voltage Un.   |
|                                    | UNL m (UN setting voLtage)   | Sets the existing value for nominal voltage Un.   |
|                                    | DCO m (DC judging On/off)  | Sets judgment ON or OFF for relative steady-state voltage change dc.  |
|                                    | DCL m (DC judging Limit)   | Sets the judging limit for relative steady-state voltage change dc.   |
|                                    | DXO m (DmaX judging On/off)  | Sets judgment ON or OFF for maximum relative voltage change dmax.   |
|                                    | DXL m (Dmax judging Limit)   | Sets the judging limit for maximum relative voltage change dmax.  |
|                                    | DTO m (DT judging On/off)  | Sets judgment ON or OFF for the period d (t) 200 ms during which voltage exceeds the threshold level within one voltage change. |
|                                    | DTL m1,m2 (DT judging Limit)   | Sets the judging limit for the period d (t) 200 ms during which voltage exceeds the threshold level within one voltage change.  |
|                                    | PSO m (PSt judging On/off)   | Sets judgment ON or OFF for short-term flicker value Pst.   |
|                                    | PSL m (PSt judging Limit)  | Sets the judging limit for short-term flicker value Pst.  |
|                                    | PLO m (PLt judging On/off)   | Sets judgment ON or OFF for long-term flicker value Plt.  |
|                                    | PLL m (PLt judging Limit)  | Sets the judging limit for long-term flicker value Plt.   |
|                                    | PLN m (PLt N value)  | Sets N value for long-term flicker value Plt.   |
|                                    | FI m1,m2 (Flicker pst Interval)  | Sets the time required for each measurement of short-term flicker value Pst.  |
|                                    | FM m (Flicker Measuring count)   | Sets the number of times measurement of short-term flicker value Pst is to be performed.  |
|                                    | DNL m (DmiN judging Limit)   | Sets the steady-state range dimin.  |
| FE m (Flicker Element)             | Sets the element for which flicker measurement is to be performed.           |   |
| OJ m (Output Judging data)         | Requests output of flicker judgment result data.                             |   |
| CPF (output CPF data)              | Requests output of CPF (cumulative probability function) data.               |   |
| OK m1,m2 (Output flicker function) | Sets communication output items for flicker measurement.                     |   |
| OKD m (Output flicker Default)     | Sets communication output items to default settings for flicker measurement. |   |

## Appendix 1.2 Commands

**AA/AA?** Sets auto or manual range mode for the current ranges/queries the current setting.

**Syntax** **AAm1,m2** <terminator>  
 "m1" indicates input element.  
 m1= 0 : All elements (setting not possible during query)  
     1 : Element 1  
     2 : Element 2 (possible only for the 3-phase 4 wire model)  
     3 : Element 3  
 "m2" indicates whether range mode is auto or manual.  
 m2=0 : Manual range  
     1 : Auto range

**Query** **AAm1?** <terminator>

**Response example**

**AA1,0**

**Description**

- Auto range is not allowed while integration is in progress; execution error 13 will occur.
- If the range is changed during auto range mode, manual range mode will be validated instead of auto range mode.
- If integration is started during auto range mode, auto range mode will be invalidated.
- It is not possible to set auto range if the external shunt range has been selected. If such an attempt is made, execution error 14 will occur.
- Auto range is turned OFF during flicker measurement mode. If an attempt is made to turn auto range ON during flicker measurement mode, error 20 will occur.
- "m1" of AAm1? indicates the input element selected. If "0" is set, error 12 will occur.

**AB** Causes the printer to stop printing.

**Syntax** **AB** <terminator>

**Description** • This command is not valid unless printing is in progress.

**AC/AC?** Sets attenuation constant for normal measurement/queries the current setting. The constant set is used as the attenuation constant for exponential averaging, or as the number of data for moving averaging.

**Syntax** **ACm** <terminator>  
 "m" indicates attenuation constant.  
 m= 1 : 8  
     2 : 16  
     3 : 32  
     4 : 64  
     5 : 128  
     6 : 256

**Query** **AC?** <terminator>

**Response example**

**AC1**

**Description** • For the attenuation constant for harmonic analysis, refer to Section 7.5, "Using Averaging Functions".

**AF/AF?** Determines whether or not the anti-aliasing filter is used for harmonic analysis/queries the current setting.

**Syntax** **AFm** <terminator>  
 "m" indicates whether anti-aliasing filter is ON or OFF.  
 m= 0 : OFF  
     1 : ON

**Query** **AF?** <terminator>

**Response example**

**AF1**

**AG/AG?** Determines whether or not averaging should be performed/queries the current setting.

**Syntax** **AGm** <terminator>  
 "m" indicates whether averaging is ON or OFF.  
 m= 0 : OFF  
     1 : ON

**Query** **AG?** <terminator>

**Response example**

**AG0**

**Description**

- Averaging is not allowed while integration is in progress; execution error 13 will occur.
- Averaging is set to OFF during flicker measurement. If an attempt is made to set averaging to ON, error 20 will occur.

**AH/AH?** Sets D/A output items for harmonic analysis/queries the current setting. Up to 14 items can be selected and output.

**Syntax** **AH m1,m2,m3,m4** <terminator>  
 "m1" indicates the D/A output channel.  $1 \leq m1 \leq 14$   
 "m2" indicates the output item no.  
 m2=0 : No output (None)  
     1 : Total rms value of 1st up to n<sup>th</sup> harmonic of voltage, analysis value of each harmonic from 1st up to n<sup>th</sup>  
     2 : Total rms value of 1st up to n<sup>th</sup> harmonic of current, analysis value of each harmonic from 1st up to n<sup>th</sup>  
     3 : Total rms value of 1st up to n<sup>th</sup> harmonic of active power, analysis value of each harmonic from 1st up to n<sup>th</sup>  
     4 : Reactive power (var)  
     5 : Apparent power (VA)  
     6 : Power factor (PF)  
     7 : PLL source frequency (Sync)  
     11 : Phase angle (deg) between fundamentals  
     16 : Harmonic distortion of voltage (VTHD)  
     17 : Harmonic distortion of current (ATHD)  
     19 : Content of each harmonic (from 2nd to n<sup>th</sup>) of voltage (V%)  
     20 : Content of each harmonic (from 2nd to n<sup>th</sup>) of current (A%)  
     21 : Content of each harmonic (from 2nd up to n<sup>th</sup>) of active power (W%)  
     22 : Phase angle of current of 1st and voltage of each harmonic from 2nd to n<sup>th</sup> in relation to voltage of the 1st harmonic (Vdeg)  
     23 : Phase angle of voltage of 1st and current of each harmonic from 2nd to n<sup>th</sup> in relation to current of the 1st harmonic (Adeg)  
 "m3" indicates element.  
 m3= 1 : Element 1  
     2 : Element 2 (possible with the 3-phase 4-wire model only)  
     3 : Element 3  
     4 :  $\Sigma$  (V, A, W, var, VA, PF only)  
 "m4" indicates the order.  $0 \leq m4 \leq 50$   
 m4=0 : When total rms value of 1st to n<sup>th</sup> of voltage, current or active power or an item except the order is selected  
     1-n<sup>\*</sup> : When analysis value of each harmonic from 1st to n<sup>th</sup> of voltage, current or active power or phase angle (Vdeg, Adeg) is selected  
     2-n<sup>\*</sup> : When content (V%, A%, W%) is selected  
 \* "n" is the upper limit of the harmonic order.

**Query** **AHm1?** <terminator>

**Response example**

**AH1,1,1,1**

**Description**

- If m2 is set to "0" (None), make sure that m3 and m4 are set to "1" and "0" respectively, since selection of element and order has no effect. Even if m2 is set to a value except for "0" (None), make sure that m3 and m4 are set to "1" and "0" respectively if the selected item does not relate to element or order.
- "m1" of AHm1? indicates the D/A output channel.

**AHD/AHD?** output items for harmonic analysis to the default settings/queries the current setting. Two sets of default settings are available.

**Syntax** **AHDm** <terminator>  
 m= 1 : Default 1 (DFLT-1)  
     2 : Default 2 (DFLT-2)  
     3 : Manual setting (SEL)

**Query** **AHD?** <terminator>

**Response example**

**AHD1**

**Description** • Executing the AH command when the setting mode is not manual will activate manual setting mode (AHD3).

**AT/AT?** Sets averaging type (exponential or moving) for normal measurement/queries the current setting.

**Syntax** **AMm** <terminator>  
 "m" indicates averaging type.  
 m= 0 : Exponential averaging  
 1 : Moving averaging

**Query** **AT?** <terminator>

**Response example**  
**AT0**

**Description** • Exponential averaging is always used as averaging method for harmonic analysis.

**AV/AV?** Sets auto or manual range mode/queries the current setting.

**Syntax** **AVm1,m2** <terminator>  
 "m1" indicates input element.  
 m1=0 : All elements (setting not possible during query)  
 1 : Element 1  
 2 : Element 2 (possible only for the 3-phase 4-wire model)  
 3 : Element 3  
 "m2" indicates whether range mode is auto or manual.  
 m2=0 : Manual range  
 1 : Auto range

**Query** **AVm1?** <terminator>

**Response example**  
**AV1,0**

**Description** • Auto range is not allowed while integration is in progress; execution error 13 will occur.  
 • If the range is changed during auto range mode, manual range mode will be validated instead of auto range mode.  
 • If integration is started during auto range mode, auto range mode will be invalidated.  
 • Auto range is turned OFF during flicker measurement mode. If an attempt is made to turn auto range ON during flicker measurement mode, error 20 will occur.  
 • "m1" of AVm1? indicates the input element selected. If "0" is set for m1, error 12 will occur.

**CF/CF?** Sets the crest factor/queries the current setting.

**Syntax** **CFm** <terminator>  
 "m" indicates the crest factor.  
 m= 1 : Crest factor 3  
 6 : Crest factor 6

**Query** **CF?** <terminator>

**Response example**  
**CF3**

**Description** • It is not possible change the crest factor while integration is in progress; execution error 13 will occur.  
 • Executing this command in flicker measurement mode during measurement of voltage fluctuation or display of judgment result will cause execution error 20.

**CM/CM?** Selects command/output format group/queries the current setting.

**Syntax** **CMn** <terminator>  
 "m" indicates command/output format group used.  
 m= 0 : 2531 command/output format group (collective setting of scaling constants)  
 1 : 2531 command/output format group (element-by-element setting of scaling constants)  
 2 : 2533E command/output format group  
 3 : WT2030 command/output format group

**Query** **CM?** <terminator>

**Response example**  
**CM3**

**Description** • For the command/output format which differs from that used for this instrument in case CM0, CM1 or CM2 is selected, refer to Appendix 1.5 and 1.6.

**CPF** Requests communications output of CPF (cumulative probability function) data obtained during the previous observation period.

**Syntax** **CPF m** <terminator>  
 "m" indicates element.  
 m= 1 : Element 1  
 2 : Element 2 (possible only for the 3-phase 4-wire model)  
 3 : Element 3

**Description** • This command can be executed only during measurement of voltage fluctuation or display of judgment result. Otherwise, execution error 20 will occur (since there is no data to be output).  
 • CPF data will be output in binary format, irrespective of whether the TO command is set for binary or ASCII. For a detailed description, refer to Appendix 1.4 "Data Output Format".

**DA/DA?** Sets the function for display A/queries the current setting.

**Syntax** **DAm** <terminator>  
 "m" indicates one of the following functions.  
 m= 1 : Voltage  
 2 : Current  
 3 : Power  
 15 : Elapsed time of integration (INTEG-TIME)

**Query** **DA?** <terminator>

**Response example**  
**DA1**

**Description** • Since the order of harmonic is displayed on display A during harmonic analysis, the displayed content will remain unchanged even if a function is selected. This setting becomes effective when normal measurement mode is activated.  
 • In the flicker measurement mode, the FDA command is used to set the display function, since only the flicker measurement related content is displayed. Use of the DA command to set the display function is not allowed; error 20 will occur.

**DB/DB?** Sets the function for display B/queries the current setting.

**Syntax** **DBm** <terminator>  
 "m" indicates one of the following functions.  
 • During normal measurement  
 m= 1 : Voltage (V)  
 2 : Current (A)  
 3 : Power (W)  
 • During harmonic analysis  
 m= 1 : Analysis value (V) or content (V%) of each harmonic of voltage  
 2 : Analysis value (A) or content (A%) of each harmonic of current  
 3 : Analysis value (W) or content (W%) of each harmonic of active power

**Query** **DB?** <terminator>

**Response example**  
**DB2**

**Description** • It is determined by the display format for harmonic analysis (selected by DH command) whether analysis value or content of each harmonic of voltage/current/power is displayed during harmonic analysis.  
 • This command cannot be used in the flicker measurement mode; error 20 will occur.

**DC/DC?** Sets the function for display C/queries the current setting.

**Syntax** **DCm** <terminator>  
 "m" indicates one of the following functions.  
 • During normal measurement  
 m= 1 : Voltage (V)  
 2 : Current (A)  
 3 : Power (W)  
 4 : Reactive power (var)  
 5 : Apparent power (VA)  
 6 : Power factor (PF)  
 11 : Phase angle (deg)  
 12 : Voltage peak (V peak)  
 • During harmonic analysis  
 m= 1 : Analysis value (V) of each harmonic of voltage  
 2 : Analysis value (A) of each harmonic of current  
 3 : Analysis value (W) of each harmonic of active power  
 4 : Reactive power (var)  
 5 : Apparent power (VA)  
 6 : Power factor (PF)  
 11 : Phase angle (deg) between fundamentals  
 22 : Phase angle of current of 1st and voltage of each harmonic from 2nd to n<sup>th</sup> in relation to voltage of the 1st harmonic (Vdeg)



- 23 :Phase angle of voltage of 1st and current of each harmonic from 2nd to n\*th in relation to current of the 1st harmonic (Adeg)  
 \* "n" is the upper limit of the harmonic order.

**Query DC?** <terminator>

**Response example**

DC3

**Description** • This command cannot be used in the flicker measurement mode; error 20 will occur.

**DCL/DCL?** Sets the limit for relative steady-state voltage change dc/queries the current setting.

**Syntax DCL m** <terminator>

"m" indicates the limit (%).  
 $1.00 \leq m \leq 99.99$

**Query DCL?** <terminator>

**Response example**

DCL3.00

**Description** • Executing this command during measurement of voltage fluctuation or display of judgment result will cause execution error 20.

**DCO/DCO?** Sets whether or not relative steady-state voltage change dc is used as judgment item/queries the current setting.

**Syntax DCO m** <terminator>

"m" indicates whether or not relative steady-state voltage change dc is used as judgment item.  
 m= 0 :Not used as judgment item.  
 1 :Used as judgment item.

**Query DCO?** <terminator>

**Response example**

DCO1

**Description** • Executing this command during measurement of voltage fluctuation or display of judgment result will cause execution error 20.

**DD/DD?** Sets the function for display D/queries the current setting.

**Syntax DDm** <terminator>

"m" indicates one of the following functions.

- During normal measurement
    - m= 1 :Voltage (V)
    - 2 : Current (A)
    - 3 :Power (W)
    - 7 :Input voltage frequency (VHz)
    - 8 :Input current frequency (AHz)
    - 9 :Watt-hour (Wh)
    - 10 :Ampere-hour (Ah)
    - 13 :Current peak (A peak)
    - 14 : Efficiency and computed result (MATH)
    - 24 : Positive watt-hour (Wh+)
    - 25 :Negative watt-hour (Wh-)
    - 26 :Positive ampere-hour (Ah+)
    - 27 :Negative ampere-hour (Ah-)
  - During harmonic analysis
    - m= 1 : Total rms value of 1st to n\*th harmonic of voltage (V)
    - 2 :Total rms value of 1st to n\*th harmonic of current (A)
    - 3 :Total rms value of 1st to n\*th harmonic of active power (W)
    - 7 :Input voltage frequency (VHz)
    - 8 :Input current frequency (AHz)
    - 16 :Harmonic distortion of voltage (VTHD)
    - 17 :Harmonic distortion of current (ATHD)
- \* "n" is the upper limit of the harmonic order.

**Query DD?** <terminator>

**Response example**

DD3

**Description** • If watt-hour/ampere-hour (Wh, Wh+, Wh-, Ah, Ah+, Ah-) is selected during normal measurement, the integration polarity will also change (IL command) accordingly.  
 • This command cannot be used in the flicker measurement mode; error 20 will occur.

**DF/DF?** Sets equation for harmonic distortion (THD) for harmonic analysis/queries the current setting.

**Syntax DFm** <terminator>

"m" indicates the equation for harmonic distortion (THD).  
 m= 0 :IEC  
 1 :CSA

**Query DF?** <terminator>

**Response example**

DF0

**Description** • For details of equation for harmonic distortion, refer to page 9-11.

**DG/DG?** Sets the phase angle display method/queries the current setting.

**Syntax DGm** <terminator>

"m" indicates the display method.  
 m= 0 :180°  
 1 :360°

**Query DG?** <terminator>

**Response example**

DG0

**DH/DH?** Determines whether data (V, A, W) is to be displayed as measured value or relative harmonic content on display B during harmonic analysis/queries the current setting.

**Syntax DHm** <terminator>

"m" indicates display type.  
 m= 0 :Measured value (Value)  
 1 :Relative harmonic content (Cont)

**Query DH?** <terminator>

**Response example**

DH0

**Description** • When relative harmonic content is chosen, "-----" will be displayed on display B if "1" (fundamental) has been selected for the harmonic order for display A.  
 • Measured value (harmonic) is always displayed on display C.

**DL/DL?** Sets the terminator for communication output data/queries the current setting.

**Syntax DLm** <terminator>

"m" indicates terminator.

|      | GP-IB      | RS-232-C |
|------|------------|----------|
| m= 0 | :CR LF EOI | CR LF    |
| 1    | :LF        | LF       |
| 2    | :EOI       | CR       |

**Query DL?** <terminator>

**Response example**

DLO

**Description** • If measured data to be output via communication is in binary format (TO1), EOI will be used as terminator, but the settings made by the DL command remain unchanged.

**DNL/DNL?** Sets the steady-state range/queries the current setting.

**Syntax DNL m** <terminator>

"m" indicates the steady-state range (%).  
 $0.10 \leq m \leq 9.99$

**Query DNL?** <terminator>

**Response example**

DNL1.00

**Description** • Executing this command during measurement of voltage fluctuation or display of judgment result will cause execution error 20.

**DT/DT?** Sets the date for the internal clock of the instrument/queries the current setting.

**Syntax DDTm1,m2,m3** <terminator>

"m1" indicates year, and must be set within the following range.  
 $1996 \leq m1 \leq 2095$   
 "m2" indicates month, and must be set within the following range.  
 $1 \leq m2 \leq 12$   
 "m3" indicates day, and must be set within the following range.  
 $1 \leq m3 \leq 30$  or  $31$  or  $28$  or  $29$

**Query DT?** <terminator>

**Response example**

DT1996/4/1

**DTL/DTL?** Sets the judgment criteria for the period d (t) 200 ms during which relative voltage change exceeds the threshold level during a voltage change as well as sets the threshold level/queries the current setting.

**Syntax** DTL m1,m2 <terminator>

"m1" indicates the judgment criteria (ms) for the total period d (t) (200 ms) during which relative voltage change exceeds the threshold level during a voltage change.

1 ≤ m1 ≤ 99999

"m2" indicates the threshold level (%).

1.00 ≤ m2 ≤ 99.99

**Query** DTL? <terminator>

**Response example**

DTL200,300

**Description** • Executing this command during measurement of voltage fluctuation or display of judgment result will cause execution error 20.

**DTO/DTO?** Sets whether or not the period d (t) 200 ms during which relative voltage change exceeds the threshold level during a voltage change be used as judgment item/queries the current setting.

**Syntax** DTO m <terminator>

"m" indicates whether or not the period is used as judgment item.

m= 0 :Not used as judgment item.

1 :Used as judgment item.

**Query** DTO? <terminator>

**Response example**

DTO1

**Description** • Executing this command during measurement of voltage fluctuation or display of judgment result will cause execution error 20.

**DXL/DXL?** Sets the limit for the maximum relative voltage change dmax/queries the current setting.

**Syntax** DXL m <terminator>

"m" indicates the limit (%).

1.00 ≤ m ≤ 99.99

**Query** DXL? <terminator>

**Response example**

DXL4.00

**Description** • Executing this command during measurement of voltage fluctuation or display of judgment result will cause execution error 20.

**DXO/DXO?** Sets whether or not the maximum relative voltage change dmax be used as judgment item/queries the current setting.

**Syntax** DXO m <terminator>

"m" indicates whether or not the maximum relative voltage change is used as judgment item.

m= 0 :Not used as judgment item.

1 :Used as judgment item.

**Query** DXO? <terminator>

**Response example**

DXO1

**Description** • Executing this command during measurement of voltage fluctuation or display of judgment result will cause execution error 20.

**EA/EA?** Sets the element for display A/queries the current setting.

**Syntax** EA m <terminator>

"m" indicates element.

m= 1 :Element 1

2 :Element 2 (possible only for the 3-phase 4-wire model)

3 :Element 3

4 :Σ

**Query** EA? <terminator>

**Response example**

EA1

**Description** • If elapsed time of integration (INTEG-TIME) is displayed on display A, the setting of any element is not allowed; execution error 15 will occur.

- Since the analysis order is displayed on display A during harmonic analysis, the displayed content will remain unchanged even if the element is changed. The

change of element will become effective when normal measurement mode is activated.

- In the flicker measurement mode, the FEA command is used to set the display element, since only the flicker measurement related content is displayed. Using the EA command to set the display function is not allowed; error 20 will occur.

**EB/EB?** Sets the element for display B/queries the current setting.

**Syntax** EB m <terminator>

"m" indicates element.

m= 1 :Element 1

2 :Element 2 (possible only for the 3-phase 4-wire model)

3 :Element 3

4 :Σ

**Query** EB? <terminator>

**Response example**

EB1

**Description** • This command cannot be used in the flicker measurement mode; error 20 will occur.

**EC/EC?** Sets the element for display C/queries the current setting.

**Syntax** EC m <terminator>

"m" indicates element.

m= 1 :Element 1

2 :Element 2 (possible only for the 3-phase 4-wire model)

3 :Element 3

4 :Σ

**Query** EC? <terminator>

**Response example**

EC1

**Description** • This command cannot be used in the flicker measurement mode; error 20 will occur.

**ED/ED?** Sets the element for display D/queries the current setting.

**Syntax** ED m <terminator>

"m" indicates element.

m= 1 :Element 1

2 :Element 2 (possible only for the 3-phase 4-wire model)

3 :Element 3

4 :Σ

**Query** ED? <terminator>

**Response example**

ED1

**Description** • If efficiency or computed result (MATH) is displayed on display D, changing the element for display D is not allowed; execution error 15 will occur.

- This command cannot be used in the flicker measurement mode; error 20 will occur.

**E.ST, <interface message GET>**

Generates a trigger.

**Syntax** E <terminator>

ST <terminator>

<interface message GET>

**Description** • This command is valid only during sample hold mode.

**FC/FC?** Sets the line filter cut-off frequency/queries the current setting.

**Syntax** FC m <terminator>

"m" indicates the line filter cut-off frequency (Fc).

m= 0 :0.500 kHz

1 :5.500 kHz

**Query** FC? <terminator>

**Response example**

FC0

**Description** • It is not possible set the cut-off frequency during integration: execution error 13 will occur.

- It is not possible change the cut-off frequency during harmonic analysis: execution error 16 will occur.
- Executing this command in flicker measurement mode during measurement of voltage fluctuation or display of judgment result will cause execution error 20.

**FD** Feeds print paper.

**Syntax** FD m <terminator>

"m" indicates number of lines to be feed, and must be within the following range. 1 ≤ m ≤ 20

**Response example****FD1**

**Description** • When paper feed is carried out by pressing the FEED key, one line is fed each time the key is pressed.

**FDA/FDA?** Sets the function to be displayed during flicker measurement mode/queries the current setting.

**Syntax** FDA m <terminator>

"m" indicates the function.

- m= 1 :Nominal voltage (Un)
- 2 :Relative steady-state voltage change (dc)
- 3 :Maximum relative voltage change (dmax)
- 4 :Period d (t) 200 ms during which voltage change is above the threshold level
- 5 :Short-term flicker value (Pst)
- 6 :Long-term flicker value (Plt)
- 7 :Total judgment result (Total)

**Query** FDA? <terminator>

**Response example****FDA1**

**FE/FE?** Sets the element for which flicker measurement is to be performed/queries the current setting.

**Syntax** FE m <terminator>

"m" indicates whether measurement for each element is ON or OFF.

- m= 1 :Element 1 is ON
- 2 :Element 2 is ON
- 3 :Elements 1 and 2 are ON
- 4 :Element 3 is ON
- 5 :Elements 1 and 3 are ON
- 6 :Elements 2 and 3 are ON
- 7 :Elements 1, 2 and 3 are ON

**Query** FE? <terminator>

**Response example****FE1**

**Description** • Executing this command during measurement of voltage fluctuation or display of judgment result will cause execution error 20.

- If measurement is set to ON for an invalid element, the setting will be ignored. For instance, if "FE7" is set for the 3-phase 3-wire model, element 2 will be ignored, thus "FE5" will be responded when a query (FE?) is made.

**FEA/FEA?** Sets the element to be displayed during flicker measurement mode/queries the current setting.

**Syntax** FEA m <terminator>

"m" indicates element.

- m= 1 :Element 1
- 2 :Element 2 (possible only for the 3-phase 4-wire model)
- 3 :Element 3

**Query** FEA? <terminator>

**Response example****FEA1**

**FI/FI?** Sets the time required for each measurement of short-term flicker value Pst/queries the current setting.

**Syntax** FI m1,m2 <terminator>

"m1" indicates time (minute).

$0 \leq m1 \leq 15$

"m2" indicates time (second). (Seconds can be set only in even values.)

$0 \leq m2 \leq 58$

**Query** FI? <terminator>

**Response example****FI10,0**

**Description** • The time must be set between 30 seconds and 15 minutes. If the time is not set within this range, parameter error 12 will occur.

- If an odd value is set for seconds, "-1" will be deducted from the set value to make it an even value. For instance, if an attempt to set 31 seconds is made, it will be replaced by a setting of 30 seconds.
- Executing this command during measurement of voltage fluctuation or display of judgment result will

cause execution error 20.

**FK/FK?** Sets whether the measurement mode be switched to flicker measurement mode (measurement of flicker nominal voltage) or returned to normal measurement mode/queries the current setting.

**Syntax** FK m <terminator>

"m" indicates flicker measurement mode or normal measurement mode.

m= 0 :Normal measurement mode

1 :flicker measurement mode

**Query** FK? <terminator>

**Response example****FK1**

**Description** • It is not possible to switch to flicker measurement mode while integration is in progress or integration is being interrupted; error 13 will occur.

- It is not possible to switch to flicker measurement mode during harmonic analysis; error 16 will occur.
- It is not possible to return to normal measurement mode during measurement of voltage fluctuation (START/STOP indicator LED is lit) or display of judgment result (START/STOP indicator LED is not lit); error 26 will occur. To return to normal measurement mode, execute the FN command to activate measurement of nominal voltage (START/STOP indicator LED will blink), then set FK0.

**FL/FL?** Determines whether or not line filter is used/queries the current setting.

**Syntax** FLm <terminator>

"m" indicates whether filter is ON or OFF.

m= 0 :ON

1 :OFF

**Query** FL? <terminator>

**Response example****FL0**

**Description** • Filter cannot be switched ON or OFF while integration is in progress; error 13 will occur.

- Filter cannot be switched ON or OFF while harmonic analysis is in progress; error 16 will occur.
- Executing this command during measurement of voltage fluctuation or display of judgment result will cause execution error 20.

**FM/FM?** Sets the number of times measurement of short-term flicker value Pst is to be performed/queries the current setting.

**Syntax** FM m <terminator>

"m" indicates the number of times measurement of short-term flicker value Pst is to be performed.

$1 \leq m \leq 99$

**Query** FM? <terminator>

**Response example****FM12**

**Description** • Executing this command during measurement of voltage fluctuation or display of judgment result will cause execution error 20.

**FN** Resets the judgment result data and measures nominal voltage in flicker measurement mode.

**Syntax** FN <terminator>

**Description** • Executing this command when the measurement mode is not flicker measurement mode will cause execution error 25.

- Executing this command during measurement of voltage fluctuation will cause execution error 25.

**FNO/FNO?** Sets the flicker observation period no. for flicker measurement/queries the current setting.

**Syntax** FNO m <terminator>

"m" indicates the flicker observation period no.

**Query** FNO? <terminator>

**Response example****FNO1**

**FP** Stops measurement of voltage fluctuation and displays the judgment result in flicker measurement mode.

**Syntax** FP <terminator>

**Description** • Executing this command when the measurement mode is not flicker measurement mode will cause execution error 24.

- Executing this command during display of judgment result or measurement of nominal voltage will cause execution error 24.

**FS** Registers the current nominal voltage and starts measurement of voltage fluctuation in flicker measurement mode.

**Syntax** FS <terminator>

- Description**
- If UNO1 is set (to use the existing value as the rated voltage), the existing value will be registered as the nominal voltage
  - Executing this command when the measurement mode is not flicker measurement mode will cause execution error 22.
  - Executing this command during measurement of voltage fluctuation or display of judgment result will cause execution error 22.

**H/H?** Determines whether or not to add a head to measured data output via communication/queries the current setting.

**Syntax** Hm <terminator>

"m" indicates whether a header is added or not.  
 m= 0 :No header added  
 1 :Header added

**Query** H? <terminal>

**Response example**

H0

- Description**
- If measured data to be output via communication is in binary format (TO1), no header will be added, but the settings made by the H command remain unchanged.

**HA/HA?** Determines whether to set the harmonic analysis mode or return to the normal measurement mode/queries the current setting.

**Syntax** HAm <terminator>

"m" indicates whether the mode is harmonic analysis mode or normal measurement mode.  
 m= 0 :Normal measurement mode  
 1 :Harmonic analysis mode

**Query** HA? <terminator>

**Response example**

HA1

- Description**
- It is not possible to activate the harmonic analysis mode while integration is in progress or integration is being interrupted; execution error 13 will occur.
  - It is not possible to switch to harmonic analysis mode during flicker measurement mode; execution error 20 will occur.

**HD/HD?** Determines whether or not output data should be updated/queries the current setting.

**Syntax** HDm <terminator>

"m" indicates whether measured data (display and output) is not updated or updated at every display update interval.  
 m= 0 :Updates the data at each sampling rate.  
 1 :Hold

**Query** HD? <terminator>

**Response example**

HD0

**HO/HO?** Sets the maximum order for harmonic analysis/queries the current setting.

**Syntax** HOm <terminator>

"m" indicates the maximum order, and must be set within the following range.  
 $1 \leq m \leq 50$

**Query** HO? <terminator>

**Response example**

HO50

- Description**
- If the set maximum order is smaller than that displayed on display A (set by the OR command for harmonic analysis), the same order as the maximum order will be displayed.

**HW/HW?** Sets the window width for harmonic analysis/queries the current setting.

**Syntax** HW m <terminator>

"m" indicates the analysis window width (the number of periods when the fundamental frequency is 40 to 70 Hz).  
 m= 0 :16  
 1 :8  
 2 :4  
 3 :2  
 4 :1

**Query** HW? <terminator>

**Response example**

HWO

**IC/IC?** Sets the integration mode/queries the current setting.

**Syntax** ICm <terminator>

"m" indicates one of the following integration modes.

- m= 0 :Normal integration mode
- 1 :Continuous integration mode
- 2 :Real time counting standard integration mode
- 3 :Real time counting continuous integration mode

**Query** IC? <terminator>

**Response example**

IC0

- Description**
- Changing of the integration mode is not allowed while integration is in progress; execution error 13 will occur.
  - If real time counting integration mode (normal or continuous) is used, set both the start time and stop time to times after the current time. Executing the IS command after both the start time and stop time have been set will place the instrument in standby state.
  - If continuous integration mode is selected, make sure that the timer preset time is set to a value larger than "0".
  - If timer integration is to be carried out in normal integration mode, set the timer preset time to any desired value.

**IL/IL?** Sets the polarity for integrated result displayed when watt-hour or ampere-hour is selected on display D/queries the current setting.

**Syntax** IIm <terminator>

"m" indicates the polarity.

- m= 0 :SUM (Wh or Ah is displayed)
- 1 :+ (Wh+ or Ah+ is displayed)
- 2 :- (Wh- or Ah- is displayed)

**Query** IL? <terminator>

**Response example**

IL0

**IM/IM?** Specifies which causes will be allowed to generate a status byte/queries the current setting.

**Syntax** IMm <terminator>

"m" indicates the cause, and must be set within the following range.  $0 \leq m \leq 15$

- m= 1 : Computation end
- 2 : Integration Flicker end
- 4 : Syntax error
- 8 : OVER

**Query** IM? <terminator>

**Response example**

IM15

- Description**
- If more than one of these causes is to be allowed, set "m" to the sum of their individual "m" values. For instance, if all causes are to be allowed, set "m" to 15 (=1+2+4+8).

**IP** Stops integration.

**Syntax** IP <terminator>

- Description**
- If an attempt is made to stop integration when integration has already been interrupted (stopped), execution error 44 will occur.

**IR** Resets integrated result.

**Syntax** IR <terminator>

- Description**
- If an attempt is made to reset the integrated result while integration is in progress, execution error 45 will occur.

**IS** Starts integration.

**Syntax** IS <terminator>

- Description**
- If an attempt is made to start integration when integration is already in progress, execution error 42 will occur.
  - If a voltage or current peak overflow, or overrange takes place when an attempt is made to start integration, execution error 46 will occur, and integration will not be started.
  - It is not possible to use the integration function during harmonic analysis mode. If an attempt is made to start, stop or reset integration, execution error 16 will occur.
  - It is not possible to use the integration function during flicker measurement mode. If an attempt is made to start, stop or reset integration, execution error 20 will occur.

**IT/IT?** Sets the integration start time and stop time/queries the current settings.

**Syntax** ITm1/m2/m3/m4/m5/m6,m7/m8/m9/m10/m11/m12 <terminator>

"m1" indicates start year  
1996 ≤ m1 ≤ 2095  
"m2" indicates start month  
1 ≤ m2 ≤ 12  
"m3" indicates start day  
1 ≤ m3 ≤ 30 or 31 or 28 or 29  
"m4" indicates start hour  
0 ≤ m4 ≤ 23  
"m5" indicates start minute  
0 ≤ m5 ≤ 59  
"m6" indicates start second  
0 ≤ m6 ≤ 59  
"m7" indicates stop year  
1996 ≤ m7 ≤ 2095  
"m8" indicates stop month  
1 ≤ m8 ≤ 12  
"m9" indicates stop day  
1 ≤ m9 ≤ 30 or 31 or 28 or 29  
"m10" indicates stop hour  
0 ≤ m10 ≤ 23  
"m11" indicates stop minute  
0 ≤ m11 ≤ 59  
"m12" indicates stop second  
0 ≤ m12 ≤ 59

**Query** IT? <terminator>

**Response example**

IT1996/4/1/17/35/0,1996/4/3/19/35/0

**Description** • If the stop time is before the start time, parameter error 12 will occur.  
• Parameters can be separated from each other by a comma (.).

**KF/KF?** Sets the peak hold function/queries the current setting.

**Syntax** KF m <terminator>

"m" indicates function.  
m= 0 : Peak value (Vpk, Apk) only  
1 : V, A, W, VA, var, Vpk, Apk

**Query** KF? <terminator>

**Response example**

KF0

**KH/KH?** Determines whether or not peak hold is used/queries the current setting.

**Syntax** KHm <terminator>

"m" indicates whether peak hold is ON or OFF.  
m= 0 : OFF  
1 : ON

**Query** KH? <terminator>

**Response example**

KH0

**Description** • The peak hold function is effective only during normal measurement.  
• The peak hold function is set to OFF during integration. If an attempt is made to set the peak hold function to ON, error 13 will occur.  
• The peak hold function is set to OFF during harmonic analysis. If an attempt is made to set the peak hold function to ON, error 16 will occur.  
• The peak hold function is set to OFF during flicker measurement mode. If an attempt is made to set the peak hold function to ON, error 20 will occur.

**KV/KV?,KA/KA?,KW/KW?**

Sets the scaling constant/queries the current setting. KV is used for voltage measurement, KA for current measurement, and KW for power measurement.

**Syntax** KV m1,m2 <terminator>

KA m1,m2 <terminator>

KW m1,m2 <terminator>

"m1" indicates element.  
m1=0 : All elements (setting not possible during query)  
1 : Element 1  
2 : Element 2 (possible only for the 3-phase 4-wire model)  
3 : Element 3  
"m2" indicates scaling constant, and must be set within the following range.  
0.0001 ≤ m2 ≤ 10000.

**Query** KVm1? <terminator> KAm1? <terminator>

KWm1? <terminator>

**Response example**

KV1,1.0000 KA1,1.0000 KW1,1.0000

**Description** • If KV0?, KA0? or KW0? is set for query, parameter error 12 will occur.

**MA/MA?** Sets the measurement mode for current/queries the current setting.

**Syntax** MAm1,m2 <terminator>

"m1" indicates input element.  
m1=0 : All elements (setting not possible during query)  
1 : Element 1  
2 : Element 2 (possible only for the 3-phase 4-wire model)  
3 : Element 3  
"m2" indicates measurement mode.  
m2=0 :RMS  
1 :MEAN  
2 :DC

**Query** MAm1? <terminator>

**Response example**

MA1,0

**Description** • Changing of the measurement mode is not allowed while integration is in progress; execution error 13 will occur.  
• RMS is always selected as measurement mode during harmonic analysis. If an attempt is made to change the measurement mode to a mode other than RMS, error 16 will occur.  
• RMS is always selected as measurement mode during flicker measurement mode. If an attempt is made to change the measurement mode to a mode other than RMS, error 20 will occur.  
• "m1" of MAm1? indicates the input element selected. If "0" is set for m1, error 12 will occur.

**MT/MT?** Sets the MATH equation/queries the current setting.

**Syntax** MTm <terminator>

"m" indicates one of the following equations.  
m= 0 :Efficiency  
1 :Crest factor of voltage input waveform applied to input element 1  
2 :Crest factor of voltage input waveform applied to input element 2 (possible only for the 3-phase 4-wire model)  
3 :Crest factor of voltage input waveform applied to input element 3  
4 :Crest factor of current input waveform applied to input element 1  
5 :Crest factor of current input waveform applied to input element 2 (possible only for the 3-phase 4-wire model)  
6 :Crest factor of current input waveform applied to input element 3  
7 :Display A + Display B  
8 :Display A – Display B  
9 :Display A x Display B  
10 :Display A / Display B  
11 :Display A/(Display B)<sup>2</sup>  
12 :(Display A)<sup>2</sup>/Display B

**Query** MT? <terminator>

**Response example**

MT0

**MV/MV?** Sets the measurement mode for voltage/queries the current setting.

**Syntax** MVm1,m2 <terminator>

"m1" indicates input element.  
m1=0 : All elements (setting not possible during query)  
1 : Element 1  
2 : Element 2 (possible only for the 3-phase 4-wire model)  
3 : Element 3  
"m2" indicates measurement mode.  
m2=0 : RMS  
1 : MEAN  
2 : DC

**Query** MVm1? <terminator>

**Response example**

MV1,0

**Description** • Changing of the measurement mode is not allowed while integration is in progress; error 13 will occur.  
• RMS is always selected as measurement mode during harmonic analysis. If an attempt is made to change it, error 16 will occur.  
• "m1" of MVm1? indicates the input element selected. If "0" is set, error 12 will occur.

## Appendix 1.2 Commands

### **NL/NL?** Sets the NULL function for DC measurement.

**Syntax** NL m <terminator>

"m" indicates whether the NULL function is ON or OFF.  
 m= 0 :OFF  
 1 :ON

**Query** NL? <terminator>

**Response example**

NLO

- Description**
- The NULL function is effective only during normal measurement.
  - If the voltage/current measurement mode is not DC for all the elements, it is not possible to turn the NULL function ON. If such an attempt is made, error 15 will occur.
  - If the voltage/current auto range is ON for any of the elements, it is not possible to turn the NULL function ON. If such an attempt is made, error 15 will occur.
  - The NULL function is set to OFF during integration. If an attempt is made to set the NULL function to ON, error 13 will occur.
  - The NULL function is set to OFF during harmonic analysis. If an attempt is made to set the NULL function to ON, error 16 will occur.
  - The NULL function is set to OFF during flicker measurement mode. If an attempt is made to set the NULL function to ON, error 20 will occur.

### **OA/OA?** Sets D/A output items/queries the current settings. Up to 14 measured data can be selected and output as analog signal from the D/A converter.

**Syntax** OAm1,m2,m3 <terminator>

"m1" indicates D/A output channel, and must be set within the following range.

$1 \leq m1 \leq 14$

"m2" indicates output item no.

m2=0 :No output (None)

1 :Voltage (V)

2 :Current (A)

3 :Power (W)

4 :Reactive power (var)

5 :Apparent power (VA)

6 :Power factor (PF)

7 :Frequency (Frq)

9 :Watt-hour (Wh)

10 :Ampere-hour (Ah)

11 :Phase angle (deg)

12 :Voltage peak (Vpk)

13 :Current peak (Apk)

14 :Efficiency and computed result (MATH)

15 :Elapsed time of integration (INTEG-TIME)

24 :Positive watt-hour (Wh+)

25 :Negative watt-hour (Wh-)

26 :Positive ampere-hour (Ah+)

27 :Negative ampere-hour (Ah-)

"m3" indicates element.

m3=1 :Element 1

2 :Element 2 (possible only for the 3-phase 4-wire model)

3 :Element 3

4 :Σ (except for Vpk and Apk)

**Query** OAm1? <terminator>

**Response example**

OA1,1,1

- Description**
- It is possible to select non output (m2=0), frequency and (m2=7), efficiency and computed result (m2=14), and elapsed time of integration (m2=15), whichever element is selected. However, it is best to set m3 to 1 if the OA command is used to select any of those items.
  - If voltage peak value (Vpk) or current peak value (Apk) is selected, it is not possible to set Σ (m3=4). If such an attempt is made, error 12 will occur.
  - When "14" (efficiency and computed result) is selected for "m2", the D/A output will be 0 V if the equation for MATH selected by MT command is not for efficiency (m=0).

### **OAD/OAD?** Initializes D/A output items/queries the current settings. Two sets of default settings are available. The same initialization can also be performed using a key operation.

**Syntax** OADm <terminator>

"m" indicates default no.

m= 1 :Default 1 (DFLT-1)

2 :Default 2 (DFLT-2)

3 : Manual setting (SEL)

**Query** OAD? <terminator>

**Response example**

OAD1

- Description**
- Manual setting mode (OAD3) is validated automatically when the OA command is executed if "m" has been set to "1" (default 1) or "2" (default 2).
  - If default 1 is selected, items displayed on displays C and D are the same as those output on channels 13 and 14. Therefore, these output items (for channels 13 and 14) will be changed if items on displays C and D are changed.

### **OD** Requests output of measured data.

**Syntax** OD <terminator>

- Description**
- In the case of GP-IB interface, the OD command should be used only in addressable mode A. If the OD command is used in addressable mode B, execution error 11 will occur. Setting the addressable mode should be done using a key operation.

### **OE** Requests output of error codes via communications.

**Syntax** OE <terminator>

**Response example**

ERR011 <terminator>

| Error code | Description   |
|------------|---|
| 011        | Command error   |
| 012        | Parameter error   |
| 013        | Attempted to change settings which cannot be change while integration was in progress.  |
| 014        | Attempt made to switch to auto range mode while the external shunt range is selected.   |
| 015        | Attempted to execute a command that was protected.  |
| 016        | Attempted to execute a command that was protected while harmonic analysis was being performed.  |
| 017        | Stop time had passed when auto print mode was activated.  |
| 018        | Date/time cannot be set properly.   |
| 020        | Attempt made to execute a command while flicker measurement is in progress, that cannot be executed in such a state.                                |
| 021        | Attempted to start flicker measurement while initialization prior to flicker measurement is performed (i.e. while "init" is displayed on display B) |
| 022        | Attempted to start flicker measurement while flicker measurement is already in progress.  |
| 023        | There is no flicker output data to be printed.  |
| 024        | Attempted to stop flicker measurement even though flicker measurement was not in progress.  |
| 025        | Attempted to switch to measurement of rated voltage (initial state) while flicker measurement is in progress.                                       |
| 026        | Attempted to return to normal measurement while measurement of rated voltage (initial state) is not in progress.                                    |
| 030        | File data failure   |
| 041        | Attempted to start integration when integration had been stopped due to an irregularity.  |
| 042        | Attempt made to start integration during integration.   |
| 043        | Measurement stopped due to overflow during integration or due to a power failure.   |
| 044        | Attempt made to stop integration while integration was interrupted.   |
| 045        | Attempt made to reset integration while integration was in progress.  |
| 046        | Attempt made to start integration when peak overflow was detected.  |
| 047        | Attempt made to start integration when integration timer preset time was set to "0".  |
| 048        | Attempt made to start integration, after the stop time had already passed.  |

|     |   |
|-----|---|
| 051 | Measurement data overflow occurred. "-oL" is displayed                              |
| 052 | Voltage peak overflow occurred  |
| 053 | Current peak overflow occurred  |
| 054 | Power factor exceeded "2". "PFErr" is displayed.                                    |
| 055 | "degErr" was displayed.   |
| 056 | Frequency input level was too low or below measurement range. "ErrLo" is displayed. |
| 057 | Frequency was above the measurement range. "ErrHi," is displayed.                   |
| 058 | Computation overflow occurred. "--oF--" is displayed.                               |
| 059 | PLL sync error during harmonic analysis. "FrqEr" is displayed.                      |

**OF/OF?** Sets communication output items for normal measurement/inquiries about the current settings. To set whether or not the selected item is output for each element is possible, and the item for the selected element will be output.

**Syntax OFm1,m2** <terminator>

"m1" indicates output item no.

- m1= 1 : Voltage (V)
- 2 : Current (A)
- 3 : Power (W)
- 4 : Reactive power (var)
- 5 : Apparent power (VA)
- 6 : Power factor (PF)
- 7 : Frequency (Frq)
- 9 : Watt-hour
- 10 : Ampere-hour (Ah)
- 11 : Phase angle (deg)
- 12 : Voltage peak (Vpk)
- 13 : Current peak (Apk)
- 14 : Efficiency and computed result (MATH)
- 15 : Elapsed time of integration (INTEG-TIME)
- 24 : Positive watt-hour (Wh+)
- 25 : Negative watt-hour (Wh-)
- 26 : Positive ampere-hour (Ah+)
- 27 : Negative ampere-hour (Ah-)

"m2" indicates whether each element is ON or OFF, and must be set within the following range.

- 0 ≤ m2 ≤ 15
- m2= 1 : Element 1 is ON
- 2 : Element 2 is ON.
- 4 : Element 3 is ON.
- 8 : Σ is ON. (except for Vpk and Apk)

**Query OFm1?** <terminator>

**Response example**

**OF1,15**

**Description** • Set "m2" to the sum of their individual "m2" values.

- (Examples) m2= 0 : All elements are OFF.
- 5 : Elements 1 and 3 are ON.
- 7 : Elements 1, 2 and 3 are ON.
- 13 : Elements 1, 3 and Σ are ON.
- 15 : Elements 1, 2, 3 and Σ are ON.

- If voltage peak value (Vpk) or current peak value (Apk) is selected, setting Σ for output will be ignored.
- It is possible to select frequency (m2=7), efficiency and computed result (m2=14) and elapsed time of integration (m2=15), whichever element is selected. However, if is best to set m2 to 1 if the OF command is used to select any of those items.
- If an element which is not effective is selected (ON), such selection will be ignored. For instance, if "OF1,15" is set for the 3-phase 3-wire model, element 2 will be ignored, thus "OF1,13" will be responded when a query (OF1?) is made.

**OFD/OFD?** Initializes communication output items for normal measurement/queries the current settings. Four sets of default setting are available.

**Syntax OFDm** <terminator>

"m" indicates default no.

- m= 0 : All items are OFF. (CLEAR)
- 1 : Default 1 (DFLT-1)
- 2 : Default 2 (DFLT-2)
- 3 : All items are ON. (ALL)

4 : Manual setting (SEL) (Response only when a query is made)

**Query OFD?** <terminator>

**Response example**

**OFD1**

**Description** • Manual setting mode (OFD4) is validated automatically when the OF command is executed if "m" is set to a value except for "4" (manual setting). Thus, m=4 (manual setting) is effective only for response to a query, and setting OFD4 will not cause an error, but has no effect.

**OH/OH?** Sets communication output items for harmonic analysis/queries the current settings. It is possible to set whether or not the selected item is output for each element, and the item for the selected element will be output.

**Syntax OHm1,m2** <terminator>

"m1" indicates output item no.

- m2= 0 : No output (None)
  - m1= 1 : Total rms value of 1st up to n<sup>th</sup> harmonic of voltage, analysis value of each harmonic from 1st up to n<sup>th</sup>
  - 2 : Total rms value of 1st up to n<sup>th</sup> harmonic of current, analysis value of each harmonic from 1st up to n<sup>th</sup>
  - 3 : Total rms value of 1st up to n<sup>th</sup> harmonic of active power, analysis value of each harmonic from 1st up to n<sup>th</sup>
  - 4 : Reactive power (var)
  - 5 : Apparent power (VA)
  - 6 : Power factor (PF)
  - 7 : PLL source frequency (Sync)
  - 11 : Phase angle (deg) between fundamentals
  - 16 : Harmonic distortion of voltage (VTHD)
  - 17 : Harmonic distortion of current (ATHD)
  - 19 : Content of each harmonic (from 2nd to n<sup>th</sup>) of voltage (V%)
  - 20 : Content of each harmonic (from 2nd to n<sup>th</sup>) of current (A%)
  - 21 : Content of each harmonic (from 2nd up to n<sup>th</sup>) of active power (W%)
  - 22 : Phase angle of current of 1st and voltage of each harmonic from 2nd to n<sup>th</sup> in relation to voltage of the 1st harmonic (Vdeg)
  - 23 : Phase angle of voltage of 1st and current of each harmonic from 2nd to n<sup>th</sup> in relation to current of the 1st harmonic (Adeg)
- "m2" indicates whether each element is ON or OFF, and must be within the following range.
- 0 ≤ m2 ≤ 15
  - m2= 1 : Element 1 is ON.
  - 2 : Element 2 is ON.
  - 4 : Element 3 is ON.
  - 8 : Σ is ON. (V, A, W, var, VA, PF only)
  - \* "n" is the upper limit of the harmonic order.

**Query OHm1?** <terminator>

**Response example**

**OH1,7**

**Description** • Set "m2" to the sum of their individual "m2" values.

(Examples) m2= 0 : All elements are OFF.

- 5 : Elements 1 and 3 are ON.
- 7 : Elements 1, 2 and 3 are ON.

- It is possible to set PLL source frequency (Sync), whichever element is selected. However, it is best to set m2 to 1 if the OH command is used to select any of those items.
- If an element which is not effective is selected (ON), such selection will be ignored. For instance, if "OH1,7" is set for the 3-phase 3-wire model, element 2 will be ignored, thus "OH1,5" will be the response when a query (OH1?) is made.

**OHD/OHD?** Initializes communication output items for harmonic analysis/queries the current settings. Four sets of default setting are available.

**Syntax OHDm** <terminator>

"m" indicates default no.

- m= 0 : All items are OFF. (CLEAR)
- 1 : Default 1 (DFLT-1)
- 2 : Default 2 (DFLT-2)

- 3 :All items are ON. (ALL)
- 4 :Manual setting (SEL) (Response only when a query is made)

**Query** **OHD?** <terminator>

**Response example**

**OHD1**

**Description** • Manual setting mode (OHD4) is validated automatically when the OH command is executed if "m" is set to a value except for "4" (manual setting) Thus, m=4 (manual setting) is effective only for response to a query, and setting OHD4 will not cause an error, but has no effect.

**OJ** **Requests output of judgment result data for each flicker observation period.**

**Syntax** **OJ m** <terminator>

"m" indicates the observation period no.  
 $1 \leq m \leq 99$

**Description** • The OJ command requests output of the latest measured data for the current observation period, whilst the OJ command requests output of the measured data (judgment result data) obtained during past observation periods.

- This command can be executed only during measurement of voltage fluctuation or display of judgment result. Otherwise, execution error 20 will occur (since there is no data to be output).
- The OJ command can be executed only in addressable mode A. Executing this command in addressable mode B will cause error 11.

**OK/OK?** **Sets communication output items for flicker measurement/queries the current setting. To set whether or not the selected items is output for each element is possible, and the item for the selected element will be output.**

**Syntax** **OK m1,m2** <terminator>

"m1" indicates output item no.  
 m= 1 :Rated voltage (Un)  
 2 :Relative steady-state voltage change (dc)  
 3 :Maximum relative voltage change (dmax)  
 4 :Period d (t) 200 ms during which voltage exceeds the threshold level within one voltage change  
 5 :Short-term flicker value (Pst)  
 6 :Long-term flicker value (Plt)  
 7 :Total judgment result (Total)  
 8 :Rated voltage frequency  
 9 :Elapsed time of measurement of voltage fluctuation  
 "m2" indicates whether output for each element is ON or OFF, and must be set within the following range.  
 m2=1 :Element 1 is ON  
 2 :Element 2 is ON  
 3 :Elements 1 and 2 are ON  
 4 :Element 3 is ON  
 5 :Elements 1 and 3 are ON  
 6 :Elements 2 and 3 are ON  
 7 :Elements 1, 2 and 3 are ON

**Query** **lkm1?** <terminator>

**Response example**

**OK1,7**

**Description** • If output is set to ON for an invalid element, the setting will be ignored.  
 For instance, if "OK1,7" is set for the 3-phase 3-wire model, element 2 will be ignored, thus "OK1,5" will be responded when a query (OK1?) is made.

**OKD/OKD?** **Sets communication output items to default settings for flicker measurement/queries the current setting. Four sets of default setting are available.**

**Syntax** **OKD m** <terminator>

"m" indicates default no.  
 m= 0 :All items are OFF. (CLEAR)  
 1 :Default 1 (DFLT-1)  
 2 :Default 2 (DFLT-2)  
 3 :All items are ON. (ALL)  
 4 :Manual setting (SEL) (Response only when an inquiry is made)

**Query** **OKD?** <terminator>

**Response example**

**OKD1**

**Description** • Manual setting mode (OKD4) is validated automatically when the OK command is executed if "m" is set to a value except for "4" (manual setting). Thus, m=4 (manual setting) is effective only for response to a query, and setting OKD4 will not cause an error, but has no effect.

**OR/OR?** **Sets harmonic order to be displayed on display A/queries the current setting.**

**Syntax** **ORm** <terminator>

"m" indicates harmonic order, and must be set within the following range.  
 $1 \leq m \leq 50$  (The harmonic order must be smaller than the maximum order.)

**Query** **OR?** <terminator>

**Response example**

**OR1**

**Description** • If the selected order exceeds the maximum order set by HO command or if it exceeds the maximum limit determined by the fundamental frequency of the input set by PS command, parameter error 12 will occur.

**OS** **Requests output of panel set-up information via communications.**

**Syntax** **OS** <terminator>

**Response example**

```
Line 1: Model name
MODEL253103 <terminator>
Line 2: Voltage range
RV1,9;AV1,0;RV2,9;AV2,0;RV3,9;AV3,0 <terminator>
Line 3: Current range
RA1,10;AA1,0;SA1,50.000;RA2,10;AA2,0;SA2,50.000;
RA3,10;AA3,0;SA3,50.000 <terminator>
Line 4: Display function
DA1;DB2;DC3;DD3; <terminator>
Line 5: Display element
EA1;EB1;EC1;ED1 <terminator>
Line 6: Measurement condition
WR1;FL0;FC0;KH0;KF0;QF0;NL0;CF3;SC0;AG0;
HD0;SI0;MT0;DG0 <terminator>
Line 7: Measurement mode
MV1,0;MV2,0;MV3,0;MA1,0;MA2,0;MA3,0
<terminator>
Line 8: Scaling constant
KV1,1.0000;KA1,1.0000;KW1,1.0000;KV2,10000;
KA2,10000;KW2,10000;KV3,1.0000;KA3,10000;
KW3,1.0000 <terminator>
Line 9: Averaging setting
AT0;AC1 <terminator>
Line 10: Integration setting
IC0;TM0,0;IL0 <terminator>
Line 11: Harmonic analysis setting (possible only for the /HRM model)
DH1;PS1;AF0;DF0;HW0;HO50;HA0;OR1<terminator>
Line 12: Printer setting (possible only for the /B5 model)
PR0;PY0;PI0,1,0 <terminator>
Line 13: D/A output setting (possible only for the /DA model)
RT1,0 <terminator>
Line 14: Flicker measurement setting 1 (possible only for the /FLK model)
FK0;FE7;FI10,0;FM12;FDA1;FEA1;FNO1
<terminator>
Line 15: Flicker measurement setting 2 (possible only for the /FLK model)
UNO0;UNL230.00;DCO1;DCL3.00;DXO1;DXL4.00;DTO1;
DTL200,3.00 <terminator>
Line 16: Flicker measurement setting 3 (possible only for the /FLK model)
PSO1;PSL1.00;PLO1;PLL0.65;PLN12;DNL1.00
<terminator>
Line 17: Command/format group
CM3 <terminator>
Line 18: Output end
END <terminator>
```

**Description** • The number of lines varies depending on the options used and model type.  
 • For lines containing items which are set for each element, output items vary depending on the model type.



**PF/PF?** Sets print output items for normal measurement/queries the current settings. To set whether or not the selected item is output for each element is possible, and the item for the selected element will be output.

**Syntax** PFM1,m2 <terminator>

"m1" indicates print output item no.

- m1= 1 :Voltage (V)  
 2 :Current (A)  
 3 :Power (W)  
 4 :Reactive power (var)  
 5 :Apparent power (VA)  
 6 :Power factor (PF)  
 7 :Frequency (Frq)  
 9 :Watt-hour (Wh)  
 10 :Ampere-hour (Ah)  
 11 :Phase angle (deg)  
 12 :Voltage peak (Vpk)  
 13 :Current peak (Apk)  
 14 :Efficiency and computed result (MATH)  
 15 :Elapsed time of integration (INTEG-TIME)  
 24 :Positive watt-hour (Wh+)  
 25 :Negative watt-hour (Wh-)  
 26 :Positive ampere-hour (Ah+)  
 27 :Negative ampere-hour (Ah-)

"m2" indicates whether each element is ON or OFF, and must be set within the following range.

- 0 ≤ m2 ≤ 15  
 m2=0 :No output (None)  
 m2=1 :Element 1 is ON  
 2 :Element 2 is ON.  
 4 :Element 3 is ON.  
 8 :Σ is ON. (except for Vpk and Apk)

**Query** PFM1? <terminator>

**Response example**

PF1,15

**Description** • Set "m2" to the sum of their individual "m2" values.

(Examples) m2= 0 :All elements are OFF.

- 5 :Elements 1 and 3 are ON.  
 7 :Elements 1, 2 and 3 are ON.  
 13 :Elements 1, 3 and Σ are ON.  
 15 :Elements 1, 2, 3 and Σ are ON.

- It is possible to select frequency (m2=7), efficiency and computed result (m2=14) and elapsed time of integration (m2=15), whichever element is selected. However, it is best to set m2 to 1 if the PF command is used to select any of those items.
- If voltage peak value (Vpk) or current peak value (Apk) is selected, setting Σ for output will be ignored.
- If an element which is not effective is selected (ON), such selection will be ignored. For instance, if "PF1,15" is set for the 3-phase 3-wire model, element 2 will be ignored, thus "PF1,13" will be the response when a query (PF1?) is made.

**PFD/PFD?** Initializes print output items for normal measurement/queries the current settings. Four sets of default setting are available.

**Syntax** PFDm <terminator>

"m" indicates default no.

- m= 0 :All items are OFF. (CLEAR)  
 1 :Default 1 (DFLT-1)  
 2 :Default 2 (DFLT-2)  
 3 :All items are ON. (ALL)  
 4 :Manual setting (SEL) (Response only when an inquiry is made)

**Query** PFD? <terminator>

**Response example**

PFD1

**Description** • Manual setting mode (PFD4) is validated automatically when the PF command is executed if "m" is set to a value except for "4" (manual setting). Thus, m=4 (manual setting) is effective only for response to a query, and setting PFD4 will not cause an error, but has no effect.

**PH/PH?** Sets print output items for harmonic analysis/queries the current settings. To set whether or not the selected item is output for each element is possible, and the item for the selected element will be output.

**Syntax** PHm1,m2 <terminator>

"m1" indicates print output item no.

- m1= 1 :Analysis voltage value and relative harmonic content are printed in numeric. (V)  
 2 :Analysis current value and relative harmonic content are printed in numeric. (A)  
 3 :Analysis active power value and relative harmonic content are printed in numeric. (W)  
 4 :Phase angle of voltage of each harmonic from 2nd to n<sup>th</sup> in relation to voltage of the 1st and phase angle of voltage of each harmonic from 2nd to n<sup>th</sup> in relation to current of the 1st are printed in numeric. (deg)  
 5 :Analysis voltage value is printed in graph. (GV)  
 6 :Analysis current value is printed in graph. (GA)  
 7 :Analysis active power value is printed in graph. (GW)  
 8 :Phase angle of voltage of each harmonic from 2nd to n<sup>th</sup> in relation to voltage of the 1st is printed in graph. (GVD)  
 9 :Phase angle of current of each harmonic from 2nd to n<sup>th</sup> in relation to current of the 1st is printed in graph. (GAD)  
 10 :Relative harmonic content of voltage is printed in graph. (CGV)  
 11 :Relative harmonic content of current is printed in graph. (CGA)  
 12 :Relative harmonic content of active power is printed in graph. (CGW)

"m2" indicates whether each element is ON or OFF, and must be within the following range.

- 0 ≤ m2 ≤ 7  
 m2= 1 :Element 1 is ON.  
 2 :Element 2 is ON.  
 4 :Element 3 is ON.  
 \* "n" is the upper limit of the harmonic order.

**Query** PHm1? <terminator>

**Response example**

PH1,7

**Description** • Set "m2" to the sum of their individual "m2" values.

(Examples) m2= 0 :All elements are OFF.

- 5 :Elements 1 and 3 are ON.  
 7 :Elements 1, 2 and 3 are ON.

- If an element which is not effective is selected (ON), such selection will be ignored. For instance, if "PH1,7" is set for the 3-phase 3-wire model, element 2 will be ignored, thus "PH1,5" will be the response when a query (PH1?) is made.

**PHD/PHD?** Initializes print output items for harmonic analysis/queries the current settings. Four sets of default setting are available.

**Syntax** PHDm <terminator>

"m" indicates default no.

- m= 0 :All items are OFF. (CLEAR)  
 1 :Default 1 (DFLT-1)  
 2 :Default 2 (DFLT-2)  
 3 :All items are ON. (ALL)  
 4 :Manual setting (SEL) (Response only when a query is made)

**Query** PHD? <terminator>

**Response example**

PHD1

**Description** • Manual setting mode (PHD4) is validated automatically when the PH command is executed if "m" is set to a value except for "4" (manual setting). Thus, m=4 (manual setting) is effective only for response to a query, and setting PHD4 will not cause an error, but has no effect.

## Appendix 1.2 Commands

**PI/PI?** Sets print interval in auto print mode/queries the current setting.

**Syntax** **PI** m1,m2,m3 <terminator>  
"m1" indicates hour  
 $0 \leq m1 \leq 99$   
"m2" indicates minute  
 $0 \leq m2 \leq 59$   
"m3" indicates second  
 $0 \leq m3 \leq 59$

**Query** **PI?** <terminator>

**Response example**

**PI0,1,0**

**Description** • The minimum settable print interval is 10 seconds. If the interval is set below 10 seconds, parameter error 12 will occur.

**PK/PK?** Sets printer output items for flicker measurement/queries the current setting. To set whether or not the selected items is output for each element is possible, and the item for the selected element will be output.

**Syntax** **PK** m1,m2 <terminator>  
"m1" indicates printer output item no.  
m1= 1 :Cumulative probability function graph (CPF)  
2 :Flicker meter judgment result table  
"m2" indicates whether printer output for each element is ON or OFF, and must be set within the following range.  
m2= 1 :Element 1 is ON  
2 :Element 2 is ON  
3 :Elements 1 and 2 are ON  
4 :Element 3 is ON  
5 :Elements 1 and 3 are ON  
6 :Elements 2 and 3 are ON  
7 :Elements 1, 2 and 3 are ON

**Query** **Pk**m1? <terminator>

**Response example**

**PK1,7**

**Description** • If printer output is set to ON for an invalid element, the setting will be ignored.  
For instance, if "PK1,7" is set for the 3-phase 3-wire model, element 2 will be ignored, thus "PK1,5" will be responded when a query (PK1?) is made.

**PKD/PKD?** Sets printer output items to default settings for flicker measurement/queries the current setting. Four sets of default setting are available.

**Syntax** **PKD** m <terminator>  
"m" indicates default no.  
m= 0 :All items are OFF. (CLEAR)  
1 :Default 1 (DFLT-1)  
2 :Default 2 (DFLT-2)  
3 :All items are ON. (ALL)  
4 :Manual setting (SEL) (Response only when an inquiry is made)

**Query** **PKD?** <terminator>

**Response example**

**PKD1**

**Description** • Manual setting mode (PKD4) is validated automatically when the PK command is executed if "m" is set to a value except for "4" (manual setting). Thus, m=4 (manual setting) is effective only for response to a query, and setting PKD4 will not cause an error, but has no effect.

**PLL/PLL?** Sets the limit for long-term flicker value Plt/queries the current setting.

**Syntax** **PLL** m <terminator>  
"m" indicates the limit.  
 $0.10 \leq m \leq 99.99$

**Query** **PLL?** <terminator>

**Response example**

**PLL0.65**

**Description** • Executing this command during measurement of voltage fluctuation or display of judgment result will cause execution error 20.

**PLN/PLN?** Sets N value for long-term flicker value Plt (constant used in Plt equation)/queries the current setting.

**Syntax** **PLN** m <terminator>  
"m" indicates N value.  
 $1 \leq m \leq 99$

**Query** **PLN?** <terminator>

**Response example**

**PLN12**

**Description** • Executing this command during measurement of voltage fluctuation or display of judgment result will cause execution error 20.

**PLO/PLO?** Sets whether or not long-term flicker value Plt be used as judgment item/queries the current setting.

**Syntax** **PLO** m <terminator>  
"m" indicates whether or not long-term flicker value is used as judgment item.  
m= 0 :Not used as judgment item.  
1 :Used as judgment item.

**Query** **PLO?** <terminator>

**Response example**

**PLO1**

**Description** • Executing this command during measurement of voltage fluctuation or display of judgment result will cause execution error 20.

**PO** Prints out measured data.

**Syntax** **PO** <terminator>

**Description** • This command is valid whether print mode is auto or manual.

**PP** Prints out panel set-up information.

**Syntax** **PP** <terminator>

**PR/PR?** Sets print mode /queries the current setting.

**Syntax** **PR**m <terminator>  
"m" indicates print mode.  
m= 0 :Auto print OFF  
1 :Auto print ON

**Query** **PR?** <terminator>

**Response example**

**PR0**

**PS/PS?** Sets the input to be used as the fundamental frequency (PLL source) for PLL synchronization/queries the current setting.

**Syntax** **PS**m <terminator>  
"m" indicates the input to be used as the PLL source.  
m= 1 :V1  
2 :A1  
3 :V2 (possible only for the 3-phase 3-wire model)  
4 :A2 (possible only for the 3-phase 3-wire model)  
5 :V3  
6 :A3

**Query** **PS?** <terminator>

**Response example**

**PS1**

**PSL/PSL?** Sets the limit for short-term flicker value Pst/queries the current setting.

**Syntax** **PSL** m <terminator>  
"m" indicates the limit.  
 $0.10 \leq m \leq 99.99$

**Query** **PSL?** <terminator>

**Response example**

**PSL1.00**

**Description** • Executing this command during measurement of voltage fluctuation or display of judgment result will cause execution error 20.

**PSO/PSO?** Sets whether or not short-term flicker value Pst be used as judgment item/queries the current setting.

**Syntax** **PSO** m <terminator>  
"m" indicates whether or not short-term flicker value is used as judgment item.  
m= 0 :Not used as judgment item.  
1 :Used as judgment item.

**Query** **PSO?** <terminator>

**Response example**

**PSO1**

**Description** • Executing this command during measurement of voltage fluctuation or display of judgment result will cause execution error 20.

**PT/PT?** **Sets the integration start time and stop time/queries the current settings.**

**Syntax** **PT m1/m2/m3/m4/m5/m6,m7/m8/m9/m10/m11/m12** <terminator>

"m1" indicates start year

1996 ≤ m1 ≤ 2095

"m2" indicates start month

1 ≤ m2 ≤ 12

"m3" indicates start day

1 ≤ m3 ≤ 30 or 31 or 28 or 29

"m4" indicates start hour

0 ≤ m4 ≤ 23

"m5" indicates start minute

0 ≤ m5 ≤ 59

"m6" indicates start second

0 ≤ m6 ≤ 59

"m7" indicates stop year

1996 ≤ m7 ≤ 2095

"m8" indicates stop month

1 ≤ m8 ≤ 12

"m9" indicates stop day

1 ≤ m9 ≤ 30 or 31 or 28 or 29

"m10" indicates stop hour

0 ≤ m10 ≤ 23

"m11" indicates stop minute

0 ≤ m11 ≤ 59

"m12" indicates stop second

0 ≤ m12 ≤ 59

**Query** **PT?** <terminator>

**Response example**

**PT1996/4/1/17/35/0, 1996/4/3/19/35/0**

**Description** • If the stop time is before the start time, parameter error 12 will occur.  
• Parameters can be separated from each other by a comma (,).

**PY/PY?** **Sets the print synchronous method for auto print mode/queries the current setting.**

**Syntax** **PYm** <terminator>

"m" indicates synchronous print method.

m= 0 :Start/stop time synchronous print method

1 :Integration time synchronous print method

2 :Flicker measurement synchronous print method  
(possible only for the /FLK model)

**Query** **PY?** <terminator>

**Response example**

**PY0**

**Description** • Changing the synchronous print method during auto print mode (PR1) is not allowed; execution error 15 will occur. To change the synchronous print method, set auto print to OFF, then change the method.

**QF/QF?** **Sets the frequency filter ON or OFF/queries the current setting.**

**Syntax** **QFm** <terminator>

"m" indicates whether the frequency filter is ON or OFF.

m= 0 :OFF

1 :ON

**Query** **QF?** <terminator>

**Response example**

**QF0**

**RA/RA?** **Sets current range/queries the current setting.**

**Syntax** **RAm1,m2** <terminator>

"m1" indicates input element.

m1=0 :All elements

1 :Element 1

2 :Element 2 (possible only for the 3-phase 3-wire model)

3 :Element 3

"m2" indicates current range.

m2= 5 :1 A range

6 :2 A range

7 :5 A range

8 :10 A range

9 :20 A range

10 :30 A range

15 :50 mV range

16 :100 mV range

17 :200 mV range

**Query** **RAM1?** <terminator>

**Response example**

**RA1,10**

**Description** • Changing of the current range is not allowed while integration is in progress; execution error 13 will occur.  
• Executing this command in flicker measurement mode during measurement of voltage fluctuation or display of judgment result will cause execution error 20.  
• Ranges 50mV, 100mV and 200mV are available for the external shunt. To use these ranges, set the correct shunt current value using the SA command.  
• If an inquiry is made using RA0?, error 12 will occur.

**RC** **Initializes panel set-up information.**

**Syntax** **RC** <terminator>

**Description** • It is not possible to initialize the following communications-related set-up information using this command.

Communication mode

GP-IB address (if the GP-IB interface is used)

Handshake, format and baud rate (if the RS-232-C is used)

**RT/RT?** **Sets the rated integration time when integrated values are to be output as an analog signal/queries the current setting.**

**Syntax** **RTm1,m2** <terminator>

"m1" indicates hour

0 ≤ m1 ≤ 999

"m2" indicates minute

0 ≤ m2 ≤ 59

**Query** **RT?** <terminator>

**Response example**

**RT1,0**

**Description** • The settable minimum time is 1 (minute). If the time is set to 0 hour 0 minute, parameter error 12 will occur.

**RV/RV?** **Sets voltage range/queries the current setting.**

**Syntax** **RVm1,m2** <terminator>

"m1" indicates input element.

m1=0 :All elements

1 :Element 1

2 :Element 2 (possible only for the 3-phase 3-wire model)

3 :Element 3

"m2" indicates voltage range.

m2= 2 :10 V range

3 :15 V range

4 :30 V range

5 :60 V range

6 :100 V range

7 :150 V range

8 :300 V range

9 :600 V range

**Query** **RVm1?** <terminator>

**Response example**

**RV1,9**

**Description** • Changing of the voltage range is not allowed while integration is in progress; execution error 13 will occur.  
• Executing this command in flicker measurement mode during measurement of voltage fluctuation or display of judgment result will cause execution error 20.  
• "m1" entered by RVm1? indicates the input element selected. If "0" is set, error 12 will occur.

**SA/SA?** Sets the external shunt current/queries the current setting.

**Syntax** **Sam1,m2** <terminator>  
 "m1" indicates element.  
 m1=0 :All elements (setting not possible during inquiry)  
 1 :Element 1  
 2 :Element 2 (possible only for the 3-phase 3-wire model)  
 3 :Element 3  
 "m2" indicates the external shunt current.  
 $0.0200 \leq m2 \leq 1000.0$

**Query** **SAm1?** <terminator>

**Response example**  
**SA1,50.000**

**Description** • If a query is made using SA0?, parameter error 12 will occur.

**SC/SC?** Determines whether or not to use the scaling function/queries the current setting.

**Syntax** **SCm** <terminator>  
 "m" indicates whether scaling is ON or OFF.  
 m= 0 :OFF  
 1 :ON

**Query** **SC?** <terminator>

**Response example**  
**SC0**

**SI/SI?** Sets the sample rate/queries the current setting.

**Syntax** **SI m** <terminator>  
 "m" indicates sample rate.  
 m= 0 :0.250 s  
 1 :0.500 s  
 2 :2.000 s

**Query** **SI?** <terminator>

**Response example**  
**SI0**

**Description** • The sample rate is fixed to 2.0 sec during integration. If an attempt is made to set the sample rate, error 13 will occur.  
 • The sample rate is fixed to 2.0 sec during flicker measurement mode. If an attempt is made to set the sample rate, error 20 will occur.

**SL** Recalls panel set-up information from a selected file.

**Syntax** **SLm** <terminator>  
 "m" indicates file no., and must be set within the following range.,  $1 \leq m \leq 4$

**Description** • It is not possible to recall the following communications-related set-up information using this command.  
 Communication mode  
 GP-IB address (if the GP-IB interface is used)  
 Handshake, format and baud rate (if the RS-232-C is used)  
 • This command cannot be executed during integration; error 13 will occur.  
 • It is not possible to load the flicker measurement set-up information during harmonic analysis. If such an attempt is made, error 16 will occur.  
 It is also not possible to load the harmonic analysis set-up information during flicker measurement. If such an attempt is made, error 20 will occur.  
 In either case, first return to normal measurement mode, then load the set-up information.

**SS** Stores panel set-up information into a selected file.

**Syntax** **SSm** <terminator>  
 "m" indicates file no., and must be set within the following range.  
 $1 \leq m \leq 4$

**TI/TI?** Sets the time on the instrument's internal clock/queries the current setting.

**Syntax** **TIm1,m2,m3** <terminator>  
 "m1" indicates hour  
 $0 \leq m1 \leq 23$

"m2" indicates minute  
 $0 \leq m2 \leq 59$   
 "m3" indicates second  
 $0 \leq m3 \leq 59$

**Query** **TI?** <terminator>

**Response example**  
**TI17/15/0**

**TM/TM?** Sets integration timer preset time/queries the current setting.

**Syntax** **TMm1,m2** <terminator>  
 "m1" indicates hour  
 $0 \leq m1 \leq 999$   
 "m2" indicates minute  
 $0 \leq m2 \leq 59$

**Query** **TM?** <terminator>

**Response example**  
**TM1,0**

**Description** • It is not possible to change the integration timer preset time during integration; execution error 13 will occur.

**TO/TO?** Sets the data format for measured data to be output via communication/queries the current setting.

**Syntax** **TOm** <terminator>  
 "m" indicates data format.  
 m= 0 :ASCII  
 1 :Binary

**Query** **TO?** <terminator>

**Response example**  
**TO0**

**Description** • If binary format (m=1) is selected, measured data will be output without header and with terminator EOI. However, the settings made by the H and DL command will remain unchanged.

**UNL/UNL?** Sets the existing value for rated voltage Un/queries the current setting.

**Syntax** **UNL m** <terminator>  
 "m" indicates the existing value, and must be set within the following range.  
 $0.01 \leq m \leq 999.99$

**Query** **UNL?** <terminator>

**Response example**  
**UNL230.00**

**Description** • Executing this command during measurement of voltage fluctuation or display of judgment result will cause execution error 20.

**UNO/UNO?** Sets the acquisition method for rated voltage Un/queries the current setting.

**Syntax** **UNO m** <terminator>  
 "m" indicates the acquisition method for rated voltage.  
 m= 0 :Acquires by measurement.  
 1 :Uses the existing value.

**Query** **UNO?** <terminator>

**Response example**  
**UNO0**

**Description** • Executing this command during measurement of voltage fluctuation or display of judgment result will cause execution error 20.

**WR/WR?** Sets the wiring system/queries the current setting.

**Syntax** **WRm** <terminator>  
 m= 1 :1Φ2W  
 2 :1Φ3W  
 3 :3Φ3W  
 4 :3Φ4W (possible only for the 3-phase 4-wire model)  
 5 :3V3A (possible only for the 3-phase 4-wire model)

**Query** **WR?** <terminator>

**Response example**  
**WR1**

## Appendix 1.3 Status Byte Format

| DIO8                           | DIO7 | DIO6  | DIO5            | DIO4 | DIO3            | DIO2                          | DIO1               |
|--------------------------------|------|-------|-----------------|------|-----------------|-------------------------------|--------------------|
| Integration<br>Flicker<br>BUSY | SRQ  | ERROR | Printer<br>BUSY | OVER | Syntax<br>ERROR | Integration<br>Flicker<br>END | Computation<br>END |

### Integration Flicker BUSY (DIO 8)

This bit is set to "1" when integration is in progress or during measurement of voltage fluctuation. This bit cannot be disabled by the IM command since it is a status bit. Even if this bit is set to "1", SRQ will not be affected.

### SRQ(DIO 7)

This bit is set to "1" when computation END (DIO 1), integration END (DIO 2), OVER (DIO 4) or syntax ERROR (DIO 3) occurs. When RQS is set to "1", SRQ is set to TRUE, issuing a service request to the controller. This bit is reset to "0" when a response is sent to the serial poll. To prevent the SRQ and status byte being affected by computation END, integration END, OVER or syntax ERROR, this bit must be disabled by the IM command.

After an "IM15", SRQ is affected by a computation END, integration END, syntax ERROR or OVER.

After an "IM1", SRQ is affected only by a computation END.

In the case of "IM4", the SRQ is affected only by a syntax ERROR.

### ERROR(DIO 6)

When a syntax ERROR or OVER occurs, this bit is set to "1" and the SRQ is set to TRUE.

### Printer BUSY (DIO 5)

This bit is set to "1" when printing of data is in progress. This bit cannot be disabled by the IM command since it is a status bit. Even if this bit is set to "1", SRQ will not be affected.

### OVER(DIO 4)

This bit is set to "1" and the SRQ is set to TRUE when an overrange occurs in the measured data. However, this is not valid if the bit has been disabled by the IM command. This bit is reset after a response is made to the serial poll. The nature of OVER can be identified by the OE command.

### Syntax ERROR (DIO 3)

This bit is set to "1" when a command error, parameter error or execution error occurs. The error no. can be identified by the OE command. This bit is reset after a response is made to the serial poll. However, this is not valid if the bit has been disabled by the IM command.

### Integration Flicker END (DIO 2)

This bit is set to "1" when integration has been completed or when each observation period for short-term flicker value Pst has been completed in flicker measurement mode.

### Computation END (DIO 1)

This bit is set to "1" when computation has been completed and the display is updated. The bit is reset when a response is made to the serial poll. However, this is not valid if the bit has been disabled by the IM command.

## Appendix 1.4 Data Output Format

### Output Format for Measured/Computed Data

#### Data Format

Measured data normally consists of 6 bytes of header and 11 bytes of data.

|        |      |
|--------|------|
| Header | Data |
|--------|------|

#### Header Section

The header section consists of 6 bytes (h1 to h6.)

|    |    |    |    |    |    |
|----|----|----|----|----|----|
| h1 | h2 | h3 | h4 | h5 | h6 |
|----|----|----|----|----|----|

h1 to h4: Data type, element

- When the data type is V\_\_ to A/B

h1 to h3: Data type

|   |                                   |                            |
|---|-----------------------------------|----------------------------|
| V__ : Voltage                                 | A__ : Current                     | W__ : Power                |
| VA_ : Apparent power                          | Var : Reactive power              | PF_ : Power factor         |
| HzV : Voltage frequency                       | HzA : Current frequency           | Wh_ : Watt-hour            |
| Ah_ : Ampere-hour                             | DEG : Phase angle                 | Wh+ : Positive watt-hour   |
| Wh- : Negative watt-hour                      | Ah+ : Positive ampere-hour        | Ah- : Negative ampere-hour |
| Vpk : Peak voltage                            | Apk : Peak current                |                            |
| Eff : Efficiency                              | HM_ : Elapsed time of integration |                            |
| CV1 : Crest factor of V1                      | CA1 : Crest factor of A1          |                            |
| CV2 : Crest factor of V2                      | CA2 : Crest factor of A2          |                            |
| CV3 : Crest factor of V3                      | CA3 : Crest factor of A3          |                            |
| A+B : Value on display A + Value on display B |                                   |                            |
| A-B : Value on display A - Value on display B |                                   |                            |
| A*B : Value on display A * Value on display B |                                   |                            |
| A/B : Value on display A / Value on display B |                                   |                            |

h4: Element

1 : Element 1    2 : Element 2    3 : Element 3    4 : Σ  
 \_ : No element (for Eff, HM\_, CV1 to A/B)

- When the data type is A/B2 or A2/B

h1 to h4: Data type

A/B2 : Display A/(Display B)<sup>2</sup>  
 A2/B : (Display A)<sup>2</sup>/Display B

h5 : Data state

N : Normal    I : Overrange    O : Computation overflow    P : Peak overflow  
 E : No data

h6 : Indicates phase lead or lag when the data type is DEG (phase angle).

"\_" (space) is selected if the data type is not DEG.

G : Lag    D : Lead    \_ : Not detectable

#### Data Section

The data section consists of 11 bytes (d1 to d11.)

|    |    |    |    |    |    |    |    |    |     |     |
|----|----|----|----|----|----|----|----|----|-----|-----|
| d1 | d2 | d3 | d4 | d5 | d6 | d7 | d8 | d9 | d10 | d11 |
|----|----|----|----|----|----|----|----|----|-----|-----|

d1 : Polarity ; \_ (space) or - (minus)  
 d2 to d8 : Mantissa, floating-point number of the maximum 6 digits  
 d9 to d11 : Exponent    E-3==> m, E+0, E+3==> k, E+6 ==> M  
 If the data type is Eff  
 d9 : %    d10 to d11 : \_ (space)

- Data state in the case of an overrange (  $\alpha L$ , - - - - is displayed. )

|    |    |    |    |   |   |   |   |   |   |   |   |   |   |   |   |   |
|----|----|----|----|---|---|---|---|---|---|---|---|---|---|---|---|---|
| h1 | h2 | h3 | h4 | I | _ | _ | 9 | 9 | 9 | 9 | 9 | 9 | . | E | + | 3 |
|----|----|----|----|---|---|---|---|---|---|---|---|---|---|---|---|---|

- Data state in the case of a computation overflow

(  $\alpha F$ , PFErr, dEGEr, ErrLo, ErrHi, is displayed. )

|    |    |    |    |   |   |   |   |   |   |   |   |   |   |   |   |   |
|----|----|----|----|---|---|---|---|---|---|---|---|---|---|---|---|---|
| h1 | h2 | h3 | h4 | O | _ | _ | 8 | 8 | 8 | 8 | 8 | 8 | . | E | + | 0 |
|----|----|----|----|---|---|---|---|---|---|---|---|---|---|---|---|---|

- Data state in the case of no data

"I" of data causing an overrange becomes "E".

- Elapsed time of integration

|   |   |   |   |   |   |    |    |    |    |    |    |    |    |    |
|---|---|---|---|---|---|----|----|----|----|----|----|----|----|----|
| H | M | _ | _ | N | _ | d1 | d2 | d3 | d4 | d5 | d6 | d7 | d8 | d9 |
|---|---|---|---|---|---|----|----|----|----|----|----|----|----|----|

d1 to d3 : Elapsed time of integration Hour  
 d4 : “ : ”  
 d5 to d6 : Elapsed time of integration Minute  
 d7 : “ : ”  
 d8 to d9 : Elapsed time of integration Second

**Output Format when "SEL" (manual setting) is Selected**

Measured/computed data can be output simultaneously, and the user is allowed to choose any output items. Each output block is of the following format.

|         |      |            |                             |  |      |      |      |            |      |            |
|---------|------|------------|-----------------------------|--|------|------|------|------------|------|------------|
| Line 1  | V_1  | A_1        | W_1                         | VA_1   | Var1 | PF_1 | DEG1 | Vpk1       | Apk1 | Terminator |
| Line 2  | HM_  | Wh_1       | Wh+1                        | Wh-1   | Ah_1 | Ah+1 | Ah-1 | Terminator |      |            |
| Line 3  | V_2  | A_2        | W_2                         | VA_2   | Var2 | PF_2 | DEG2 | Vpk2       | Apk2 | Terminator |
| Line 4  | HM_  | Wh_2       | Wh+2                        | Wh-2   | Ah_2 | Ah+2 | Ah-2 | Terminator |      |            |
| Line 5  | V_3  | A_3        | W_3                         | VA_3   | Var3 | PF_3 | DEG3 | Vpk3       | Apk3 | Terminator |
| Line 6  | HM_  | Wh_3       | Wh+3                        | Wh-3   | Ah_3 | Ah+3 | Ah-3 | Terminator |      |            |
| Line 7  | V_4  | A_4        | W_4                         | VA_4   | Var4 | PF_4 | DEG4 | Terminator |      |            |
| Line 8  | HM_  | Wh_4       | Wh+4                        | Wh-4   | Ah_4 | Ah+4 | Ah-4 | Terminator |      |            |
| Line 9  | Hz** | Eff_       | Terminator                  | Hz** : Input to be used for frequency measurement (one of HzV1 to HzA3)<br>Eff_ : Efficiency (Eff_) or computed result (CV1 to A/B_) |      |      |      |            |      |            |
| Line 10 | END  | Terminator | END: Block end line ("END") |  |      |      |      |            |      |            |

Each output block normally consists of 10 lines including the block end line ("END"). However, if all output items on a line are set to "no output", this line will be omitted, reducing the number of output lines to 10. For instance, if all output items (V\_2 to Apk2) are set to "no output", line 3 will be omitted.

Furthermore, if any output item on a line is set to "no output", all data following this item on the line will be shifted forward. For instance, if A\_3 on line 5 is set to "no output", V\_3 will be followed immediately by the data for W\_3.

**Note**

- Lines 3 and 4 are not output with the 3-phase 3-wire model.

**Output Format when "DFLT-1" is Selected**

|        |      |            |     |            |  |
|--------|------|------------|-----|------------|--|
| Line 1 | V_1  | A_1        | W_1 | Terminator |  |
| Line 2 | V_2  | A_2        | W_2 | Terminator |  |
| Line 3 | V_3  | A_3        | W_3 | Terminator |  |
| Line 4 | V_4  | A_4        | W_4 | Terminator |  |
| Line 5 | Hz** | Terminator |     |            | Hz**: Input to be used for frequency measurement (one of HzV1 to HzA3) |
| Line 6 | END  | Terminator |     |            | END: Block end line ("END")  |

**Note**

---

- Line 2 is not output with the 3-phase 3-wire model.
- 

**Output Format when "DFLT-2" is Selected**

|         |      |            |      |      |      |      |      |  |
|---------|------|------------|------|------|------|------|------|--|
| Line 1  | W_1  | Terminator |      |      |      |      |      |  |
| Line 2  | HM_  | Wh_1       | Wh+1 | Wh-1 | Ah_1 | Ah+1 | Ah-1 | Terminator   |
| Line 3  | W_2  | Terminator |      |      |      |      |      |  |
| Line 4  | HM_  | Wh_2       | Wh+2 | Wh-2 | Ah_2 | Ah+2 | Ah-2 | Terminator   |
| Line 5  | W_3  | Terminator |      |      |      |      |      |  |
| Line 6  | HM_  | Wh_3       | Wh+3 | Wh-3 | Ah_3 | Ah+3 | Ah-3 | Terminator   |
| Line 7  | W_4  | Terminator |      |      |      |      |      |  |
| Line 8  | HM_  | Wh_4       | Wh+4 | Wh-4 | Ah_4 | Ah+4 | Ah-4 | Terminator   |
| Line 9  | Hz** | Terminator |      |      |      |      |      | Hz**: Input to be used for frequency measurement (one of HzV1 to HzA3) |
| Line 10 | END  | Terminator |      |      |      |      |      | END: Block end line ("END")  |

**Note**

---

- Lines 3 and 4 are not output with the 3-phase 3-wire model.
-



## Output Format for Harmonic Analysis Data

### Data Format

Output data consists of 8 bytes of header and 11 bytes of data.

|        |      |
|--------|------|
| Header | Data |
|--------|------|

### Header Section

The header section consists of 8 bytes (h1 to h8.)

|    |    |    |    |    |    |    |    |
|----|----|----|----|----|----|----|----|
| h1 | h2 | h3 | h4 | h5 | h6 | h7 | h8 |
|----|----|----|----|----|----|----|----|

h1 to h3 : Data type

V\_ \_ : Total rms value of 1st to n<sup>\*</sup>th of voltage, analysis value of each harmonic from 1st to n<sup>\*</sup>th of voltage

A\_ \_ : Total rms value of 1st to n<sup>\*</sup>th of current, analysis value of each harmonic from 1st to n<sup>\*</sup>th of current

W\_ \_ : Total rms value of 1st to n<sup>\*</sup>th of active power, analysis value of each harmonic from 1st to n<sup>\*</sup>th of active power

VA\_ : Apparent power

Var : Reactive power

PF\_ : Power factor of 1st

HzV : Fundamental frequency of PLL source voltage

HzA : Fundamental frequency of PLL source current

DEG : Phase angle between fundamentals

VTH : Harmonic distortion of voltage

ATH : Harmonic distortion of current

VCN : Content of each harmonic from 2nd to n<sup>\*</sup>th of voltage

ACN : Content of each harmonic from 2nd to n<sup>\*</sup>th of current

WCN : Content of each harmonic from 2nd to n<sup>\*</sup>th of active power

DGV : Phase angle of current of 1st and voltage of each harmonic from 2nd to n<sup>\*</sup>th in relation to voltage of the 1st

DGA : Phase angle of voltage of 1st and current of each harmonic from 2nd to n<sup>\*</sup>th in relation to current of the 1st

h4 : Element

1 : Element 1            2 : Element 2            3 : Element 3

4 :  $\Sigma$  (total rms value of harmonic from 1st to n<sup>\*</sup>th of V\_ \_ , A\_ \_ and W\_ \_ , VA\_ , Var and PF)

h5 : Data state

N : Normal            I : Overrange            O : Computation overflow    P : Peak overflow

E : No data

h6, h7 : Order

01 to 50 : Order of the fundamental or harmonic (must be smaller than the maximum order)

\_ : No order (total rms value of harmonic from 1st to n<sup>\*</sup>th of V\_ \_ , A\_ \_ and W\_ \_ , VA\_ , Var, PF\_ , HzV, HzA, DEG, VTH, ATH)

h8 : Indicates phase lead or lag when the data type is DGV or DGA, and order is 01.

“\_” (space) is selected if the data type is not DGV or DGA.

G : Lag            D : Lead            \_ : Not detectable

\* "n" is the upper limit of the harmonic order.

### Data Section

The data section consists of 11 bytes (d1 to d11.)

|    |    |    |    |    |    |    |    |    |     |     |
|----|----|----|----|----|----|----|----|----|-----|-----|
| d1 | d2 | d3 | d4 | d5 | d6 | d7 | d8 | d9 | d10 | d11 |
|----|----|----|----|----|----|----|----|----|-----|-----|

d1 : Polarity ; \_ (space) or - (minus)

d2 to d8 : Mantissa, floating-point number of the maximum 6 digits

d9 to d11 : Exponent    E-3==> m, E+0, E+3==> k, E+6 ==> M

If the data type is VTH, ATH, VCN, ACN, WCN

d9 : %    d10 to d11 : \_ (space)

**Output Format when "SEL" (manual setting) is Selected**

Harmonic analysis data can be output simultaneously, and the user is allowed to choose any output items. Each output block is of the following format.

"###" indicates the maximum order. Data for orders exceeding the maximum order will not be output.

|        |         |         |         |         |            |                    |
|--------|---------|---------|---------|---------|------------|--------------------|
| Line 1 | V__1N__ | V__1N01 | V__1N02 | .....   | V__1N##    | Terminator         |
| Line 2 | A__1N__ | A__1N01 | A__1N02 | .....   | A__1N##    | Terminator         |
| Line 3 | W__1N__ | W__1N01 | W__1N02 | .....   | W__1N##    | Terminator         |
| Line 4 | VA_1N__ | Var1N__ | PF_1N__ | DEG1N__ | VTH1N__    | ATH1N__ Terminator |
| Line 5 | VCN1N02 | VCN1N03 | .....   | VCN1N## | Terminator |                    |
| Line 6 | ACN1N02 | ACN1N03 | .....   | ACN1N## | Terminator |                    |
| Line 7 | WCN1N02 | WCN1N03 | .....   | WCN1N## | Terminator |                    |
| Line 8 | DGV1N01 | DGV1N02 | DGV1N03 | .....   | DGV1N##    | Terminator         |
| Line 9 | DGA1N01 | DGA1N02 | DGA1N03 | .....   | DGA1N##    | Terminator         |

Line 10 to 18 Data for element 2 (data format is the same as line 1 to 9)

Line 19 to 27 Data for element 3 (data format is the same as line 1 to 9)

|         |         |            |  |         |         |         |            |
|---------|---------|------------|--|---------|---------|---------|------------|
| Line 28 | V__4N__ | A__4N__    | W__4N__  | VA_4N__ | Var4N__ | PF_4N__ | Terminator |
| Line 29 | Hz**N__ | Terminator | Hz**: PLL source frequency (one of HzV1 to HzA3) |         |         |         |            |
| Line 30 | END     | Terminator | END: Block end line ("END")                      |         |         |         |            |

Each output block normally consists of 30 lines including the block end line ("END"). However, if all output items on a line are set to "no output", this line will be omitted, reducing the number of output lines to 30. For instance, if all output items (VA\_1N\_\_ to ATH1N\_\_) are set to "no output", line 4 will be omitted. However, lines 1 to 3 and 5 to 9 will not be output if they are set to "no output", since only one output item is contained in those lines.

Furthermore, if any output item on a line is set to "no output", all data following this item on the line will be shifted forward. For instance, if Var1N\_\_ on line 4 is set to "no output", VA\_1N\_\_ will be followed immediately by the data for PF\_1N\_\_.

**Note**

- Lines 10 to 18 are not output with the 3-phase 3-wire model.

**Output Format when "DFLT-1" is Selected**

"##" indicates the maximum order. Data for orders exceeding the maximum order will not be output.

|        |         |         |            |         |            |            |
|--------|---------|---------|------------|---------|------------|------------|
| Line 1 | V_1N_   | V_1N01  | V_1N02     | .....   | V_1N##     | Terminator |
| Line 2 | A_1N_   | A_1N01  | A_1N02     | .....   | A_1N##     | Terminator |
| Line 3 | W_1N_   | W_1N01  | W_1N02     | .....   | W_1N##     | Terminator |
| Line 4 | VTH1N_  | ATH1N_  | Terminator |         |            |            |
| Line 5 | VCN1N02 | VCN1N03 | .....      | VCN1N## | Terminator |            |
| Line 6 | ACN1N02 | ACN1N03 | .....      | ACN1N## | Terminator |            |
| Line 7 | WCN1N02 | WCN1N03 | .....      | WCN1N## | Terminator |            |

Line 8 to 14 Data for element 2 (data format is the same as lines 1 to 7)

Line 15 to 21 Data for element 3 (data format is the same as lines 1 to 7)

|         |        |            |  |
|---------|--------|------------|--|
| Line 22 | Hz**N_ | Terminator | Hz**: PLL source frequency (one of HzV1 to HzA3) |
| Line 23 | END    | Terminator | END: Block end line ("END")                      |

**Note**

- Lines 8 to 14 are not output with the 3-phase 3-wire model.

**Output Format when "DFLT-2" is Selected**

"##" indicates the maximum order. Data for orders exceeding the maximum order will not be output.

|        |         |            |         |       |         |            |
|--------|---------|------------|---------|-------|---------|------------|
| Line 1 | DEG1N_  | Terminator |         |       |         |            |
| Line 2 | DGV1N01 | DGV1N02    | DGV1N03 | ..... | DGV1N## | Terminator |
| Line 3 | DGA1N01 | DGA1N02    | DGA1N03 | ..... | DGA1N## | Terminator |

Line 4 to 6 Data for element 2 (data format is the same as lines 1 to 3)

Line 7 to 9 Data for element 3 (data format is the same as lines 1 to 3)

|         |        |            |  |
|---------|--------|------------|--|
| Line 10 | Hz**N_ | Terminator | Hz**: PLL source frequency (one of HzV1 to HzA3) |
| Line 11 | END    | Terminator | END: Block end line ("END")                      |

**Note**

- Lines 4 to 6 are not output with the 3-phase 3-wire model.

**Output Format for Flicker Measurement Data**

**Data Format**

Flicker measurement data consists of 8 bytes of header and 11 bytes of data.

|               |             |
|---------------|-------------|
| <b>Header</b> | <b>Data</b> |
|---------------|-------------|

**Header Section**

The header section consists of 8 bytes (h1 to h8).

|           |           |           |           |           |           |           |           |
|-----------|-----------|-----------|-----------|-----------|-----------|-----------|-----------|
| <b>h1</b> | <b>h2</b> | <b>h3</b> | <b>h4</b> | <b>h5</b> | <b>h6</b> | <b>h7</b> | <b>h8</b> |
|-----------|-----------|-----------|-----------|-----------|-----------|-----------|-----------|

h1 to h3 : Data type

- V\_ \_ : Voltage (nominal voltage)
- HzV : Voltage frequency
- HM\_ : Elapsed time
- dc\_ : Relative steady-state voltage change (dc)
- dmx : Maximum relative voltage change (dmax)
- dt\_ : Period during which voltage change exceeds the threshold level during a voltage change in one fluctuation
- Pst : Short-term flicker value (Pst)
- Plt : Long-term flicker value (Plt)
- Ttl : Total judgment result (Total)

h4 : Element

- 1 : Element 1                      2 : Element 2                      3 : Element 3

h5 : Data state

- N : Normal                      I : Overrange                      O : Computation overflow   P : Peak overflow
- E : No data                      U : Undefined (dc)

h6 to h7 : Observation period no.

h8 : Judgment result

- \_ : No judgment              F : FAIL                      P : PASS                      I : Judgment impossible

**Data Section**

|           |           |           |           |           |           |           |           |           |            |            |
|-----------|-----------|-----------|-----------|-----------|-----------|-----------|-----------|-----------|------------|------------|
| <b>d1</b> | <b>d2</b> | <b>d3</b> | <b>d4</b> | <b>d5</b> | <b>d6</b> | <b>d7</b> | <b>d8</b> | <b>d9</b> | <b>d10</b> | <b>d11</b> |
|-----------|-----------|-----------|-----------|-----------|-----------|-----------|-----------|-----------|------------|------------|

- d1 : Polarity; \_ (space) or - (minus)
- d2 to d8 : Mantissa, floating-point number of the maximum 6 digits
- d9 to d11 : Exponent E-3==> m, E+0, E+3 ==> k, E;6 ==> M
- If the data type is dc\_ or dmx :
- d9 : %      d10 to d11 : \_(space)

- The data state in the case of overrange, computation overflow and no data is the same as the one for normal measurement.
- The data format for elapsed time is the same as the one for elapsed time of integration.
- Data when undefined (dc) (" \_ n d E F " is displayed)

|          |          |          |           |          |           |           |          |          |          |          |          |          |          |          |          |          |          |          |
|----------|----------|----------|-----------|----------|-----------|-----------|----------|----------|----------|----------|----------|----------|----------|----------|----------|----------|----------|----------|
| <b>d</b> | <b>c</b> | <b>_</b> | <b>h4</b> | <b>U</b> | <b>h6</b> | <b>h7</b> | <b>I</b> | <b>_</b> | <b>9</b> | <b>9</b> | <b>9</b> | <b>9</b> | <b>9</b> | <b>9</b> | <b>.</b> | <b>E</b> | <b>+</b> | <b>3</b> |
|----------|----------|----------|-----------|----------|-----------|-----------|----------|----------|----------|----------|----------|----------|----------|----------|----------|----------|----------|----------|

- Data for total judgment result (Total)

In the case of PASS

|          |          |          |           |          |          |          |          |          |          |          |          |          |          |          |          |          |          |          |          |
|----------|----------|----------|-----------|----------|----------|----------|----------|----------|----------|----------|----------|----------|----------|----------|----------|----------|----------|----------|----------|
| <b>T</b> | <b>t</b> | <b>I</b> | <b>h4</b> | <b>N</b> | <b>_</b> | <b>_</b> | <b>P</b> | <b>_</b> | <b>0</b> | <b>0</b> | <b>0</b> | <b>0</b> | <b>0</b> | <b>0</b> | <b>.</b> | <b>0</b> | <b>E</b> | <b>+</b> | <b>0</b> |
|----------|----------|----------|-----------|----------|----------|----------|----------|----------|----------|----------|----------|----------|----------|----------|----------|----------|----------|----------|----------|

In the case of FAIL

|          |          |          |           |          |          |          |          |          |          |          |          |          |          |          |          |          |          |          |
|----------|----------|----------|-----------|----------|----------|----------|----------|----------|----------|----------|----------|----------|----------|----------|----------|----------|----------|----------|
| <b>T</b> | <b>t</b> | <b>I</b> | <b>h4</b> | <b>N</b> | <b>_</b> | <b>_</b> | <b>F</b> | <b>-</b> | <b>0</b> | <b>0</b> | <b>0</b> | <b>0</b> | <b>1</b> | <b>.</b> | <b>0</b> | <b>E</b> | <b>+</b> | <b>0</b> |
|----------|----------|----------|-----------|----------|----------|----------|----------|----------|----------|----------|----------|----------|----------|----------|----------|----------|----------|----------|

In the case of Judgment impossible

|          |          |          |           |          |          |          |          |          |          |          |          |          |          |          |          |          |          |          |
|----------|----------|----------|-----------|----------|----------|----------|----------|----------|----------|----------|----------|----------|----------|----------|----------|----------|----------|----------|
| <b>T</b> | <b>t</b> | <b>I</b> | <b>h4</b> | <b>N</b> | <b>_</b> | <b>_</b> | <b>I</b> | <b>-</b> | <b>0</b> | <b>0</b> | <b>0</b> | <b>0</b> | <b>2</b> | <b>.</b> | <b>0</b> | <b>E</b> | <b>+</b> | <b>0</b> |
|----------|----------|----------|-----------|----------|----------|----------|----------|----------|----------|----------|----------|----------|----------|----------|----------|----------|----------|----------|

**Output Format when "SEL" (manual setting) is Selected**

|        |     |            |      |   |      |   |      |   |      |   |      |   |      |   |      |   |      |            |
|--------|-----|------------|------|---|------|---|------|---|------|---|------|---|------|---|------|---|------|------------|
| Line 1 | HM_ | ,          | V__1 | , | HzV1 | , | dc_1 | , | dmx1 | , | dt_1 | , | Pst1 | , | Plt1 | , | Ttl1 | Terminator |
| Line 2 | HM_ | ,          | V__2 | , | HzV2 | , | dc_2 | , | dmx2 | , | dt_2 | , | Pst2 | , | Plt2 | , | Ttl2 | Terminator |
| Line 3 | HM_ | ,          | V__3 | , | HzV3 | , | dc_3 | , | dmx3 | , | dt_3 | , | Pst3 | , | Plt3 | , | Ttl3 | Terminator |
| Line 4 | END | Terminator |      |   |      |   |      |   |      |   |      |   |      |   |      |   |      |            |

**Note**

- Line 2 is not output with the 3-phase 3-wire model.

**Output Format when "DFLT-1" is Selected**

|        |     |            |      |   |      |   |      |   |      |   |      |   |      |   |      |   |      |            |
|--------|-----|------------|------|---|------|---|------|---|------|---|------|---|------|---|------|---|------|------------|
| Line 1 | HM_ | ,          | V__1 | , | HzV1 | , | dc_1 | , | dmx1 | , | dt_1 | , | Pst1 | , | Plt1 | , | Ttl1 | Terminator |
| Line 2 | END | Terminator |      |   |      |   |      |   |      |   |      |   |      |   |      |   |      |            |

**Output Format when "DFLT-2" is Selected**

|        |     |            |      |   |      |   |      |   |      |   |      |   |      |            |
|--------|-----|------------|------|---|------|---|------|---|------|---|------|---|------|------------|
| Line 1 | HM_ | ,          | dc_1 | , | dmx1 | , | dt_1 | , | Pst1 | , | Plt1 | , | Ttl1 | Terminator |
| Line 2 | HM_ | ,          | dc_2 | , | dmx2 | , | dt_2 | , | Pst2 | , | Plt2 | , | Ttl2 | Terminator |
| Line 3 | HM_ | ,          | dc_3 | , | dmx3 | , | dt_3 | , | Pst3 | , | Plt3 | , | Ttl3 | Terminator |
| Line 4 | END | Terminator |      |   |      |   |      |   |      |   |      |   |      |            |

**Output Format (Binary) for Latest CPF (Cumulative Probability Function) Data Registered at Elapse of Short-term Flicker Value Measurement Time**

The CPF data is output as a response for the communication command CPFm (m indicates element).

**Data Format**

CPF data assignment (4100 bytes = 1025 x Single real data) + EOI

|          |          |       |           |           |
|----------|----------|-------|-----------|-----------|
| CPF[ 0]  | CPF[ 1]  | ..... | CPF[ 31]  |           |
| CPF[ 32] | CPF[ 33] | ..... | CPF[ 63]  |           |
| CPF[ 64] | CPF[ 65] | ..... | CPF[ 95]  |           |
|          |          |       |           |           |
| CPF[992] | CPF[993] | ..... | CPF[1023] | CPF[1024] |

For a detailed description of data format, refer to "Output Format for Binary Data" on the next page.

**Output Format for Binary Data**

**Data Section**

The data section consists of 4 bytes of IEEE SINGLE REAL data. The data can be converted to physical value using the following formula. (MSB of the data is output first.)

$$D = (-1)^S \times 2^{(E-127)} \times (1 + \frac{M}{2^{23}})$$

- D : Physical value
- S : Sign (polarity) bit (0 or 1)
- E : Exponent (0 to 254)
- M : Mantissa (23 bits of binary value)

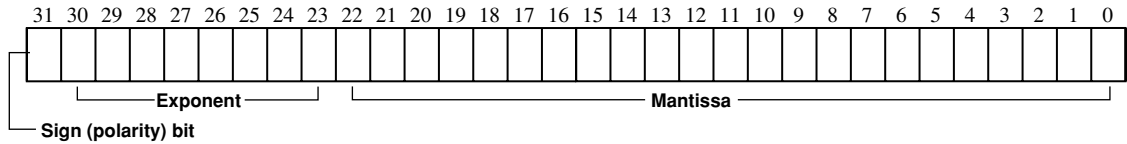

- **Data state in the case of an overrange or computation overflow**  
(*oL*, *oF*, *PFErrr*, *dEGEr*, *ErrLo*, *ErrHi* is displayed. )  
[9.9E+37] (+∞) is output.
- **Elapsed time of integration ( - - - - is displayed. )**  
[9.91E+37] (NAN) is output.
- **Elapsed time of integration, elapsed time of voltage fluctuation measurement**  
Hour: 16-bit binary value  
Minute: 8-bit binary value  
Second: 8-bit binary value

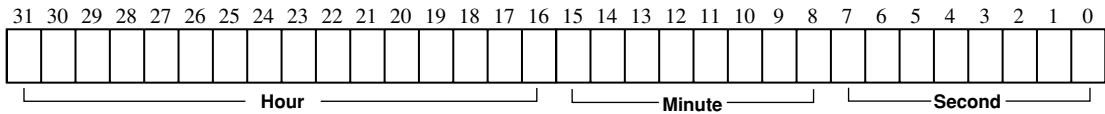

Header is always omitted, irrespective of whether or not addition of header is set by the communication command H.

**Output Format**

All data selected as described in Section 14.1, "Selecting the Output Items" is output at one time as one block data (4 bytes x number of data sets).

- Data of each items is output in the same order as ASCII format.
- No comma is inserted between data of each item to separate them.
- A terminator, which is normally added at the end of each line, is not added.
- "END", which is output as the block end line, is not output. However, "EOI" will become TRUE when the final data byte is output.

**Output Format for Set-up Information/Error Codes**

Refer to the application examples of the OS and OE commands given in the Appendix 1.2. To see the contents of the displays in these examples, refer also to the description of the commands given in the Appendix 1.2.

## Appendix 1.5 For Users Using Communication Commands of Digital Power Meter 2533E

This instrument differs from the 2533E in communications command and data format. This instrument has a function which enables the user to use communications programs created for the 2533E. This function is described below in detail.

### Communications Commands

To use 2533E command group with this instrument, setting command CM2 is required. (For a detail description of the CM command, refer to Appendix 1.2, "Commands".

Description is given below for those commands which differ from this instrument when the 2533E command group is selected.

#### Note

- For a description of how to set the addressable mode, refer to page 14-6.
- The error codes and status byte format are the same as those used with this instrument. For a detailed description, refer to page App 1-17. They differ from those used with the 2533E.
- To receive harmonic analysis data via RS-232-C interface, set handshake mode to a value other than "0", since harmonic analysis data contains a large number of output bytes.

#### AA/AA? Sets auto or manual range mode for the current ranges/queries the current setting.

**Syntax** **AAm** <terminator>  
 "m" indicates whether range mode is auto or manual.  
 m= 0 :Manual range  
 1 : Auto range

**Query** **AA?** <terminator>

#### **Response example**

**AA0**

**Description** • All elements are switched ON or OFF.  
 • Error 12 will occur when a query is made if the range modes set for each element differs from each other.

#### AV/AV? Sets auto or manual range mode for the voltage ranges/queries the current setting.

**Syntax** **AVm** <terminator>  
 "m" indicates whether range mode is auto or manual.  
 m= 0 :Manual range  
 1 :Auto range

**Query** **AV?**<terminator>

#### **Response example**

**AV0**

**Description** • All elements are switched ON or OFF.  
 • Error 12 will occur when a query is made if the range modes set for each element differs from each other.

#### DS Sets the delimiter E0I output timing. This command is used with the 2533E, but cannot be used with this instrument even if 2533E command group is selected by the CM command.

#### KV/KV?,KA/KA?,KW/KW?

Sets the scaling constant/queries the current setting. KV is used for voltage measurement, KA for current measurement, and KW for power measurement.

**Syntax** **KVm** <terminator>  
**KAm** <terminator>  
**KWm** <terminator>  
 "m" indicates scaling constant, and must be set within the following range.  
 $0.0001 \leq m \leq 10000$ .

**Query** **KV?** <terminator>  
**KA?** <terminator>  
**KW?** <terminator>

#### **Response example**

**KV1.0000**  
**KA1.0000**  
**KW1.0000**

**Description** • Voltage, current and power scaling constant for all elements are set to the same value.

#### MN/MN/? Sets the measurement mode/queries the current setting.

**Syntax** **MNm** <terminator>  
 "m" indicates measurement mode.  
 m = 0 :RMS  
 1 : MEAN  
 2 :DC

**Query** **MN?** <terminator>

#### **Response example**

**MN0**

**Description** • Parameter error 12 will occur if "m" is set to an illegal value.  
 • The same measurement mode is selected for both voltage and current for all elements.  
 • Error 12 will occur when a query is made if the measurement modes set for each element differs from each other.

#### OF/OF? Sets communication output items for normal measurement/queries the current settings. Up to 14 measured data can be selected and output.

**Syntax** **OF m1,m2,m3** <terminator>  
 "m1" indicates output channel no., and must be within the following range.  
 $1 \leq m1 \leq 14$   
 "m2" indicates output item no.  
 m2=0 :No output (None)  
 1 : Voltage (V)  
 2 :Current (A)  
 3 :Power (W)  
 4 :Reactive power (var)  
 5 :Apparent power (VA)  
 6 :Power factor (PF)  
 7 :Frequency (Frq)  
 9 :Watt-hour (Wh)  
 10 : Ampere-hour (Ah)  
 m= 0 :Manual range  
 11 :Phase angle (deg)

- 12 : Voltage peak (Vpk)
  - 13 : Current peak (Apk)
  - 14 : Efficiency and computed result (MATH)
  - 15 : Elapsed time of integration (INTEG-TIME)  
(possible only for the /INTG model)
  - 24 : Positive watt-hour (Wh+)
  - 25 : Negative watt-hour (Wh-)
  - 26 : Positive ampere-hour (Ah+)
  - 27 : Negative ampere-hour (Ah-)
- "m3" indicates element.  
m3=1 : Element 1  
2 : Element 2 (possible only for the 3-phase 4-wire model)  
3 : Element 3  
4 : Σ (except for Vpk and Apk)

**Query** OFm1? <terminator>

**Response example**

OF1,3,2

- Description** • It is possible to select no output (m=0), frequency (m2=7), efficiency and computed result (m2=14) and elapsed time of integration (m2=15), whichever element is selected. However, it is best to set m3 to 1 if the OF command is used to select any of those items.
- If voltage peak value (Vpk) or current peak value (Apk) is selected, it is not possible to set Σ (m3=4). If such an attempt is made, error 12 will occur.

**OL** **Function: Requests output of setup information. Output format differs from that of the 2533E.**

**Syntax** OL <terminator>

**Response example**

The following lines differ from the response example for OS command given on page App 1-12.

- Line 2 : Voltage range  
RV9;AV0 <terminator>
- Line 3 : Current range  
RA10;AA0;SA50.000 <terminator>
- Line 7 : Measurement mode  
MN0 <terminator>
- Line 8 : Scaling constant  
KV,1.0000;KA,1.0000;KW,1.0000  
<terminator>

- Description** • The data set for element 1 will be output if the range, auto range ON/OFF state, measurement mode, external shunt current, voltage, current and power set for each element differ from each other.

**OS** **Requests output of setup information. This command cannot be used if 2533E command group is selected by the CM command. However, in this case OL command can be used instead.**

**RA/RA?** **Sets current range/queries the current setting.**

**Syntax** RAm <terminator>

"m" indicates current range.

- m = 5 : 1A range
- 6 : 2A range
- 7 : 5A range
- 8 : 10A range
- 9 : 20A range
- 10 : 30A range
- 15 : 50mV range
- 16 : 100mV range
- 17 : 200mV range

**Query** RA? <terminator>

**Response example**

RA9

- Description** • The same current range is selected for all elements.
- Error 12 will occur when a query is made if the current range set for each element differs from each other.

**RV/RV?** **Sets voltage range/queries the current setting.**

**Syntax** RVm <terminator>

"m" indicates voltage range.

- m2=2 : 10V range
- 3 : 15V range
- 4 : 30V range
- 5 : 60V range
- 6 : 100V range
- 7 : 150V range
- 8 : 300V range
- 9 : 600V range

**Query** RV? <terminator>

**Response example**

RV9

- Description** • The same voltage range is selected for all elements.
- Error 12 will occur when a query is made if the current range set for each element differs from each other.

**SA/SA?** **Sets the external shunt current/queries the current setting.**

**Syntax** SAm <terminator>

"m2" indicates the external shunt current.

0.0200 ≤ m ≤ 1000.0

**Query** SA? <terminator>

**Response example**

SA50.000

- Description** • The same external shunt current value is selected for all elements.

**WR/WR?** **Sets the wiring system/queries the current setting.**

**Syntax** WRm <terminator>

"m" indicates wiring system.

- m= 0 : 3Φ3W
- 1 : 3Φ4W (possible only for the 3-phase 3-wire model)
- 2 : 1Φ2W
- 3 : 1Φ3W
- 4 : 3V3A (possible only for the 3-phase 3-wire model)

**Query** WR? <terminator>

**Response example**

WR2



**Output Items**

To read measured data using 2533E communication program, this instrument's addressable mode B must be set. Output items do not match those displayed on each display as in the 2533E, but match those set for ch.1 to ch.3 by the OF command of the 2533E command group. Select output items according to the 2533E communications program.

**Note**

- For the 2533E and 2531 command group, output items can be set only by using the OF command. It is not possible to set output items using the panel keys.

**Data Output Format**

Data consists of 12 bytes of header and 12 bytes of data. The entire data output format is shown below.

|             |           |   |             |           |   |             |           |
|-------------|-----------|---|-------------|-----------|---|-------------|-----------|
| ch.1 header | ch.1 data | , | ch.2 header | ch.2 data | , | ch.3 header | ch.3 data |
|-------------|-----------|---|-------------|-----------|---|-------------|-----------|

**Header Section**

|    |    |    |    |    |    |    |    |    |     |     |     |
|----|----|----|----|----|----|----|----|----|-----|-----|-----|
| h1 | h2 | h3 | h4 | h5 | h6 | h7 | h8 | h9 | h10 | h11 | h12 |
|----|----|----|----|----|----|----|----|----|-----|-----|-----|

h1 to h2 : Output channel

DA : ch.1    DB : ch.2    DC : ch.3

h1 to h4 : Data typ

- 0 : No output                      7 : HzV (Voltage frequency)    14 : MATH (Efficiency and computed result)
- 1 : V (Voltage)                    8 : HzA (Current frequency)    15 : HM (Elapsed time of integration)
- 2 : A (Current)                    9 : Wh (Watt-hour)                24 : Wh+ (Positive watt-hour)
- 3 : W (Power)                     10 : Ah (Ampere-hour)            25 : Wh- (Negative watt-hour)
- 4 : Var (Reactive power)        11 : DEG (Phase angle)         26 : Ah+ (Positive ampere-hour)
- 5 : VA(Apparent power)         12 : Vpk (Peak voltage)         27 : Ah- (Negative ampere-hour)
- 6 : PF(Power factor)            13 : Apk (Peak current)

**Note**

- If "15" is set to h3 and h4 when "DB" is set to h1 and h2, "DB4\_" is output to h1 through h4. This is done to conform to 2533E format.

h5 to h6: Output channel

EA : ch.1    EB : ch.2    EC : ch.3

h7: Element

1 : Element 1    2 : Element 2    3 : Element 3    4 : Σ

h8: Data state

N : Normal    I : Overrange/no data    O : Computation overflow

h9 to h11: Unit

- V\_\_ : V    VA\_ : VA    DEG : DEG    Wh- : Wh-
- A\_\_ : A    HZ\_ : Hz    Vpk : Vpk    Ah+ : Ah+
- W\_\_ : W    Wh\_ : Wh    Apk : Apk    Ah- : Ah-
- VAR : var    Ah\_ : Ah    Wh+ : Wh+    \_\_\_ : other

Efficiency(Eff) or MATH(CV1,CV2,CV3,CA1,CA2,CA3,A+B,A-B,A\*B,A/B,A/B(meaning A/B2),A2/(meaning A2/B))

h12: Fixed to ",".

**Data Section**

|    |    |    |    |    |    |    |    |    |     |     |     |
|----|----|----|----|----|----|----|----|----|-----|-----|-----|
| d1 | d2 | d3 | d4 | d5 | d6 | d7 | d8 | d9 | d10 | d11 | d12 |
|----|----|----|----|----|----|----|----|----|-----|-----|-----|

d1 : Polarity ; \_ (space) or - (minus)

d2 - d9 : Mantissa, floating-point number of the maximum 7 digits

d10-d12 : Exponent

- E-3 ⇒ m
- E+0
- E+3 ⇒ k
- E+6 ⇒ M

## Appendix 1.6 For Users Using Communication Commands of Digital Power Meter 2531

This instrument differs from the 2531 in communications command and data format. This instrument has a function which enables the user to use communications programs created for the 2531. This function is described below in detail.

### Communications Commands

To use 2531 command group with this instrument, setting command CM0 or CM1 is required. (For a detailed description of the CM command, refer to Appendix 1.2, "Commands".

Description is given below for those commands which differ from this instrument when the 2531 command group is selected.

**OF/OF?** Sets communication output items for normal measurement/queries the current settings. Up to 14 measured data can be selected and output.

**Syntax** **OF m1,m2,m3** <terminator>  
 "m1" indicates output channel no., and must be within the following range.  
 $1 \leq m1 \leq 14$   
 "m2" indicates output item no.  
 m2=0 : No output (None)  
 1 : Voltage (V)  
 2 : Current (A)  
 3 : Power (W)  
 4 : Reactive power (var)  
 5 : Apparent power (VA)  
 6 : Power factor (PF)  
 7 : Frequency (Frq)  
 9 : Watt-hour (Wh)  
 10 : Ampere-hour (Ah)  
 11 : Phase angle (deg)  
 12 : Voltage peak (Vpk)  
 13 : Current peak (Apk)  
 14 : Efficiency and computed result (MATH)  
 15 : Elapsed time of integration (INTEG-TIME)  
 24 : Positive watt-hour (Wh+)  
 25 : Negative watt-hour (Wh-)  
 26 : Positive ampere-hour (Ah+)  
 27 : Negative ampere-hour (Ah-)  
 "m3" indicates element.  
 m3=1 : Element 1  
 2 : Element 2 (possible only for the 3-phase 4-wire model)  
 3 : Element 3  
 4 :  $\Sigma$  (except for Vpk and Apk)

**Query** **OFm1?** <terminator>

**Response example**

**OF1,3,2**

**Description**

- It is possible to select no output (m=0), efficiency, MATH, and elapsed time of integration (m2=15), whichever element is selected. However, it is best to set m3 to 1 if the OF command is used to select any of those items.
- If voltage peak value (Vpk) or current peak value (Apk) is selected, it is not possible to set  $\Sigma$  (m3=4). If such an attempt is made, error 12 will occur.

**OFD/OFD?** Initializes communication output items for normal measurement/queries the current settings. Two sets of default setting are available.

**Syntax** **OFD m** <terminator>  
 "m" indicates default no.  
 m= 0 : Default for normal measurement  
 1 : Default for integration  
 2 : Select mode (possible only for inquiry command)

**Query** **OFD?** <terminator>

**Response example**

**OFD1**

**Description**

- Select mode (OFD2) is validated automatically when the OF command is executed if "m" is set to "0" (default for normal measurement) or "1" (default for integration).

**OH/OH?** Sets communication output items for harmonic analysis/queries the current settings.

**Syntax** **OH m1,m2** <terminator>

"m1" indicates output item no.  
 m1= 1 : Analysis voltage value and relative harmonic content are output in numeric. (V)  
 2 : Analysis current value and relative harmonic content are output in numeric. (A)  
 3 : Analysis active power value and relative harmonic content are output in numeric. (W)  
 4 : Phase angle of voltage of each harmonic from 2nd to n<sup>th</sup> in relation to voltage of the 1st and phase angle of current of each harmonic from 2nd to n<sup>th</sup> in relation to current of the 1st are output in numeric. (deg).  
 13 : Voltage, current, active power and phase angle are output in numeric. (AAL)  
 "m2" indicates input.  
 m2=0 : Elements 1, 2 and 3  
 1 : Element 1  
 2 : Element 2 (possible only for the 3-phase 4-wire model)  
 3 : Element 3  
 \* "n" is the upper limit of the harmonic order.

**Query** **OH?** <terminator>

**Response example**

**OH3,1**

**Output Format for Measured/Computed Data**

**Data Output Format**

The data format is the same as that described in Appendix 1.4 "Data Output Format". Refer to page App 1-17.

**Output Format**

Up to 14 measured/computed data can be output simultaneously, and the user is allowed to choose any output items. Each output block is of the following format.

|        |       |            |       |            |       |   |       |            |
|--------|-------|------------|-------|------------|-------|---|-------|------------|
| Line 1 | ch.1  | ,          | ch.2  | ,          | ch.3  | , | ch.4  | Terminator |
| Line 2 | ch.5  | ,          | ch.6  | ,          | ch.7  | , | ch.8  | Terminator |
| Line 3 | ch.9  | ,          | ch.10 | ,          | ch.11 | , | ch.12 | Terminator |
| Line 4 | ch.13 | ,          | ch.14 | Terminator |       |   |       |            |
| Line 5 | END   | Terminator |       |            |       |   |       |            |

Each output block normally consists of 5 lines including the block end line ("END"). However, if all output items on a line are set to "no output", this line will be omitted, reducing the number of output lines to 4. For instance, if all output items (ch.9 to ch.12) are set to "no output", line 3 will be omitted.

Furthermore, if any output item on a line is set to "no output", all data following this item on the line will be shifted forward. For instance, if ch.2 on line 2 is set to "no output", ch.1 will be followed immediately by the data for ch.3.

**Output Format when Default for Normal Measurement is Selected (DFD0)**

• **3-phase 3-wire model**

|        |           |            |           |            |                 |            |
|--------|-----------|------------|-----------|------------|-----------------|------------|
| Line 1 | V1 data   | ,          | V3 data   | ,          | $\Sigma V$ data | Terminator |
| Line 2 | A1 data   | ,          | A3 data   | ,          | $\Sigma A$ data | Terminator |
| Line 3 | W1 data   | ,          | W3 data   | ,          | $\Sigma W$ data | Terminator |
| Line 4 | Display C | ,          | Display D | Terminator |                 |            |
| Line 5 | END       | Terminator |           |            |                 |            |

• **3-phase 4-wire mode**

|        |           |            |           |            |         |   |                 |            |
|--------|-----------|------------|-----------|------------|---------|---|-----------------|------------|
| Line 1 | V1 data   | ,          | V2 data   | ,          | V3 data | , | $\Sigma V$ data | Terminator |
| Line 2 | A1 data   | ,          | A2 data   | ,          | A3 data | , | $\Sigma A$ data | Terminator |
| Line 3 | W1 data   | ,          | W2 data   | ,          | W3 data | , | $\Sigma W$ data | Terminator |
| Line 4 | Display C | ,          | Display D | Terminator |         |   |                 |            |
| Line 5 | END       | Terminator |           |            |         |   |                 |            |

Output Format when Default for Integration is Selected (DFD1)

• 3-phase 3-wire model

|        |           |            |                             |            |                  |            |
|--------|-----------|------------|-----------------------------|------------|------------------|------------|
| Line 1 | W1 data   | ,          | W3 data                     | ,          | $\Sigma$ W data  | Terminator |
| Line 2 | Wh1 data  | ,          | Wh3 data                    | ,          | $\Sigma$ Wh data | Terminator |
| Line 3 | Ah1 data  | ,          | Ah3 data                    | ,          | $\Sigma$ Ah data | Terminator |
| Line 4 | Frequency | ,          | Elapsed time of integration | Terminator |                  |            |
| Line 5 | END       | Terminator |                             |            |                  |            |

• 3-phase 4-wire mode

|        |           |            |                             |            |          |   |                  |            |
|--------|-----------|------------|-----------------------------|------------|----------|---|------------------|------------|
| Line 1 | W1 data   | ,          | W2 data                     | ,          | W3 data  | , | $\Sigma$ W data  | Terminator |
| Line 2 | Wh1 data  | ,          | Wh2 data                    | ,          | Wh3 data | , | $\Sigma$ Wh data | Terminator |
| Line 3 | Ah1 data  | ,          | Ah2 data                    | ,          | Ah3 data | , | $\Sigma$ Ah data | Terminator |
| Line 4 | Frequency | ,          | Elapsed time of integration | Terminator |          |   |                  |            |
| Line 5 | END       | Terminator |                             |            |          |   |                  |            |

**Output Format for Harmonic Analysis Data**

**Data Output Format**

The data format is the same as that described in Appendix 1.4 "Data Output Format". Refer to page App 1-18.

**Output Format**

The output format is specified as shown below according to the output items selected using the OH command.

• **Voltage or current**

|         |  |   |                           |            |
|---------|--|---|---------------------------|------------|
| Line 1  | Total rms value of harmonic from 1st to 50th | , | THD                       | Terminator |
| Line 2  | Analysis value for fundamental (1st)         | , | Frequency                 | Terminator |
| Line 3  | Analysis value for 2nd harmonic              | , | Content for 2nd harmonic  | Terminator |
|         | ⋮  |   | ⋮                         | ⋮          |
| Line 51 | Analysis value for 50th harmonic             | , | Content for 50th harmonic | Terminator |
| Line 52 | END  |   | Terminator                |            |

• **Active power**

|         |  |   |                           |            |
|---------|--|---|---------------------------|------------|
| Line 1  | Total rms value of harmonic from 1st to 50th | , | Power factor              | Terminator |
| Line 2  | Analysis value for fundamental (1st)         | , | Frequency                 | Terminator |
| Line 3  | Analysis value for 2nd harmonic              | , | Content for 2nd harmonic  | Terminator |
|         | ⋮  |   | ⋮                         | ⋮          |
| Line 51 | Analysis value for 50th harmonic             | , | Content for 50th harmonic | Terminator |
| Line 52 | END  |   | Terminator                |            |

• **Phase angle**

|         |   |   |  |            |
|---------|---|---|--|------------|
| Line 1  | Phase angle between fundamentals (1st harmonic) of voltage and current, | , | Frequency  | Terminator |
| Line 2  | Phase angle between fundamental and 2nd harmonic of voltage             | , | Phase angle between fundamental and 2nd harmonic of current  | Terminator |
| Line 3  | Phase angle between fundamental and 3rd harmonic of voltage             | , | Phase angle between fundamental and 3rd harmonic of current  | Terminator |
|         | ⋮   |   | ⋮  | ⋮          |
| Line 50 | Phase angle between fundamental and 50th harmonic of voltage            | , | Phase angle between fundamental and 50th harmonic of current | Terminator |
| Line 51 | END   |   | Terminator   |            |

• **Output order when "ALL" is selected**

Output items are output in the order of voltage → current → active power → phase angle → END (terminator).

- Each output data is output in the format specified for each output item.
- The END line is not output for each output item. The END line is output only at the end of entire output operation.

**Output Format for Set-up Information/Error Codes**

Refer to the application examples of the OS and OE commands given in the Appendix 1.2. To see the contents of the displays in these examples, refer also to the description of the commands given in the Appendix 1.2.

## Appendix1.7 Sample Programs

### Before Programming

#### Required System

- Computer : IBM PC/AT and compatible system with National Instruments AT-GPIB/TNT IEEE-488.2 board installed
- OS : Quick Basic Version 4.0/4.5

#### Basic Programming Format

The following shows the structure of a programming command statement.

Command + Parameter + Terminator

ASCII codes are used.

|         |         |           |            |
|---------|---------|-----------|------------|
| Example | DA      | 2         | CR LF      |
|         | Command | Parameter | Terminator |

#### Command

Predefined string of 1 to 3 capital letters

#### Parameter

Numeric values or character string (ASCII code)

#### Terminator

- GP-IB interface
  - When this instrument is used as a listener, "CR+LF", "LF" or "EOI" can be used.
  - When this instrument is used as a talker, the terminator set by the DL command will be used.
  - Refer to page App 1-5.
- RS-232-C
  - Refer to pages 14-12 and App 1-5.

#### Multi-Command Statement

A single line can contain multiple commands. In this case, make sure that command statements (command + parameter) are separated by a semicolon (;).

#### Note

---

- space or tab between the command and parameter can be omitted.
- 

#### Query Command

Query commands can easily be identified since "?" is added to the end of the command. Data returned in response to a query command is shown below.

|               |               |
|---------------|---------------|
| Query command | Returned data |
| DA?           | ⇒ DA1         |

#### Numerical Parameter

Floating-point parameters are correct to four decimal places.

#### Note

---

- When the message of GPIBERR or DVMERR is returned, refer to "NI-488.2 Driver Sample Programs".
-

## Sample Programs

```

*****
*
* Sample Program (1) for the WT2000 series
*
*
* Used to set measurement conditions/ranges for normal measurement mode, and read
* and display the following data each time measured/computed data is updated.
* Voltage (V), current (A), active power (W), voltage frequency (VHz)
*
*****
REM $INCLUDE: 'qbdecl.bas'

DECLARE SUB gpiberr (msg$)
DECLARE SUB dvmerr (msg$, SPR%)

CLS
PRINT

CALL IBDEV(0, 1, 0, T10s, 1, 0, dvm%)
IF (dvm% < 0) THEN CALL gpiberr("Ibdev Error")

' Interface clear
CALL IBCLR(dvm%)
IF (IBSTA% AND EERR) THEN CALL gpiberr("Ibclr Error")
' set communication command group.
WRT$ = "CM3"
CALL IBWRT(dvm%, WRT$)
IF (IBSTA% AND EERR) THEN CALL gpiberr("Ibwrt Error")

' set measurement condition.
WRT$ = "HD0;SI1;MV0,0;MA0,0;FL0;SC0;AG0"
CALL IBWRT(dvm%, WRT$)
IF (IBSTA% AND EERR) THEN CALL gpiberr("Ibwrt Error")

' set measurement range.
WRT$ = "RV0,6;RA0,7"
CALL IBWRT(dvm%, WRT$)
IF (IBSTA% AND EERR) THEN CALL gpiberr("Ibwrt Error")

' set the function of frequency to measure.
WRT$ = "DD7;ED1"
CALL IBWRT(dvm%, WRT$)
IF (IBSTA% AND EERR) THEN CALL gpiberr("Ibwrt Error")

' set communication output item.
WRT$ = "OFD1;TO0;DL0"
CALL IBWRT(dvm%, WRT$)
IF (IBSTA% AND EERR) THEN CALL gpiberr("Ibwrt Error")

' wait for setting.
FOR I% = 1 TO 10000: NEXT I%

' initialize status byte.
WRT$ = "IM1"
CALL IBWRT(dvm%, WRT$)
IF (IBSTA% AND EERR) THEN CALL gpiberr("Ibwrt Error")

' clear status byte.
CALL IBRSP(dvm%, SPR%)
IF (IBSTA% AND EERR) THEN CALL gpiberr("Ibrsp Error")

FOR I% = 1 TO 10
  'wait finished measurement.
  SBWAIT: MASK% = &H4800          ' RQS + TIMO
        CALL IBWAIT(dvm%, MASK%)
        IF (IBSTA% AND (EERR OR TIMO)) THEN CALL gpiberr("Ibwait Error")
        CALL IBRSP(dvm%, SPR%)
        IF (IBSTA% AND EERR) THEN CALL gpiberr("Ibrsp Error")
        IF ((SPR% AND &H41) <> &H41) GOTO SBWAIT

  'send request measurement data.
  WRT$ = "OD"
  CALL IBWRT(dvm%, WRT$)
  IF (IBSTA% AND EERR) THEN CALL gpiberr("Ibwrt Error")

  'read measurement data.
  RDDAT: RD$ = SPACE$(128)
        CALL IBRD(dvm%, RD$)
        IF (IBSTA% AND EERR) THEN CALL gpiberr("Ibrd Error")
        PRINT LEFT$(RD$, IBCNT% - 2)
        IF LEFT$(RD$, 3) <> "END" GOTO RDDAT

NEXT I%

' Call the IBONL function to disable the hardware and software.
CALL IBONL(dvm%, 0)

END

```

```

*****
*
* Sample Program (2) for the WT2000 series
*
* Used to carry out integration in standard integration mode, and read
* and display the following data each time measured/computed data is updated.
*   Active power (W), watt-hour (Wh, Wh+, Wh-), ampere-hour (Ah, Ah+, Ah-),
*   elapsed time of integration (IMTEG-TIME)
*
*****

    REM $INCLUDE: 'qbdecl.bas'

    DECLARE SUB gpiberr (msg$)
    DECLARE SUB dvmerr (msg$, spr%)

    CLS
    PRINT

    CALL ibdev(0, 1, 0, T10s, 1, 0, dvm%)
    IF (dvm% < 0) THEN CALL gpiberr("Ibdev Error")

' clear the device.
CALL ibclr(dvm%)
IF (ibsta% AND EERR) THEN CALL gpiberr("Ibclr Error")

' set communication command group.
wrt$ = "CM3"
CALL ibwrt(dvm%, wrt$)
IF (ibsta% AND EERR) THEN CALL gpiberr("Ibwrt Error")

' set measurement condition.
wrt$ = "HD0;MV0,0;MA0,0;FL0;SC0;AG0"
CALL ibwrt(dvm%, wrt$)
IF (ibsta% AND EERR) THEN CALL gpiberr("Ibwrt Error")

' set measurement range.
wrt$ = "RV0,6;RA0,7"
CALL ibwrt(dvm%, wrt$)
IF (ibsta% AND EERR) THEN CALL gpiberr("Ibwrt Error")

' set Integrate condition.
wrt$ = "IC0;TM1,0"
CALL ibwrt(dvm%, wrt$)
IF (ibsta% AND EERR) THEN CALL gpiberr("Ibwrt Error")

' set communication output item.
wrt$ = "OFD2;OF7,0;TO0;DL0"
CALL ibwrt(dvm%, wrt$)
IF (ibsta% AND EERR) THEN CALL gpiberr("Ibwrt Error")

' wait for setting.
FOR i% = 1 TO 10000: NEXT i%

' initialize status byte.
wrt$ = "IM3"
CALL ibwrt(dvm%, wrt$)
IF (ibsta% AND EERR) THEN CALL gpiberr("Ibwrt Error")
CALL ibrsp(dvm%, spr%)
IF (ibsta% AND EERR) THEN CALL gpiberr("Ibrsp Error")

' start integrate.
wrt$ = "IS"
CALL ibwrt(dvm%, wrt$)
IF (ibsta% AND EERR) THEN CALL gpiberr("Ibwrt Error")

' wait finished measurement.
SBWAIT:
mask% = &H4800          ' RQS + TIMO
CALL ibwait(dvm%, mask%)
IF (ibsta% AND (EERR OR TIMO)) THEN CALL gpiberr("Ibwait Error")
CALL ibrsp(dvm%, STB%)
IF (ibsta% AND EERR) THEN CALL gpiberr("Ibrsp Error")

IF ((STB% AND &H41) <> &H41) THEN GOTO INTEGEN

' send request measurement data.
wrt$ = "OD"
CALL ibwrt(dvm%, wrt$)
IF (ibsta% AND EERR) THEN CALL gpiberr("Ibwrt Error")

' read measurement data.
RDDAT:
rd$ = SPACE$(512)
CALL ibrd(dvm%, rd$)
IF (ibsta% AND EERR) THEN CALL gpiberr("Ibrd Error")

PRINT LEFT$(rd$, ibcnt% - 2)

IF LEFT$(rd$, 3) <> "END" GOTO RDDAT
INTEGEN:
IF ((STB% AND &H42) <> &H42) THEN GOTO SBWAIT

' Call the IBONL function to disable the hardware and software.
CALL ibonl(dvm%, 0)

END

```



```

*****
*
* Sample Program (3) for the WT2000 series
*
* Used to read and display the following data in harmonic analysis mode.
* Total rms value of each harmonic from 1st to 50th of current.
* analysis value of fundamental (1st) of current, analysis value of each harmonic
* (2nd to 50th), harmonic distortion of current, PLL source (voltage) frequency
*
*****
'
  REM $INCLUDE: 'qbdecl.bas'

  DECLARE SUB gpiberr (msg$)
  DECLARE SUB dvmerr (msg$, spr%)

  CLS
  PRINT

  CALL ibdev(0, 1, 0, T10s, 1, 0, dvm%)
  IF (dvm% < 0) THEN CALL gpiberr("Ibdev Error")

' clear the device.
  CALL ibclr(dvm%)
  IF (ibsta% AND EERR) THEN CALL gpiberr("Ibclr Error")

' set communication command group.
  wrt$ = "CM3"
  CALL ibwrt(dvm%, wrt$)
  IF (ibsta% AND EERR) THEN CALL gpiberr("Ibwrt Error")

' set harmonic measurement condition.
  wrt$ = "PS1;AF0;DF0;HO50"
  CALL ibwrt(dvm%, wrt$)
  IF (ibsta% AND EERR) THEN CALL gpiberr("Ibwrt Error")

' harmonic measurement start.
  wrt$ = "HA1"
  CALL ibwrt(dvm%, wrt$)
  IF (ibsta% AND EERR) THEN CALL gpiberr("Ibwrt Error")

' set communication output item.
  wrt$ = "OHD0;OH2,1;OH17,1;OH7,1;TO0;DL0"
  CALL ibwrt(dvm%, wrt$)
  IF (ibsta% AND EERR) THEN CALL gpiberr("Ibwrt Error")

' wait for setting.
  FOR I = 1 TO 1000000: NEXT I

' harmonic measurement hold and request measurement data.
  wrt$ = "HD1"
  CALL ibwrt(dvm%, wrt$)
  IF (ibsta% AND EERR) THEN CALL gpiberr("Ibwrt Error")

  wrt$ = "OD"
  CALL ibwrt(dvm%, wrt$)
  IF (ibsta% AND EERR) THEN CALL gpiberr("Ibwrt Error")

' read measurement data.
RDDAT:
  rd$ = SPACE$(1024)
  CALL ibrd(dvm%, rd$)
  IF (ibsta% AND EERR) THEN CALL gpiberr("Ibrd Error")

  PRINT LEFT$(rd$, ibcnt% - 2)
  IF LEFT$(rd$, 3) <> "END" GOTO RDDAT
' start harmonic measurement.
  wrt$ = "HD0"
  CALL ibwrt(dvm%, wrt$)
  IF (ibsta% AND EERR) THEN CALL gpiberr("Ibwrt Error")

' Call the IBONL function to disable the hardware and software.
  CALL ibonl(dvm%, 0)

END

```

```

'*****
' *
' * Sample Program (4) for the WT2000 series
' *
' * Used to set measurement conditions/ranges for normal measurement mode, and read
' * and display the following data each time measured/computed data is updated.
' * Binary data: voltage (V), current (A), active power (W), voltage frequency (VHz)
' *
'*****
'
  REM $INCLUDE: 'qbdecl.bas'

  DECLARE SUB gpiberr (msg$)
  DECLARE SUB dvmerr (msg$, SPR%)

  CLS
  PRINT

  DIM DT(13)

  CALL IBDEV(0, 1, 0, T10s, 1, 0, dvm%)
  IF (dvm% < 0) THEN CALL gpiberr("Ibdev Error")

' clear the device.
  CALL IBCLR(dvm%)
  IF (IBSTA% AND EERR) THEN CALL gpiberr("Ibclr Error")

' set communication command group.
  WRT$ = "CM3"
  CALL IBWRT(dvm%, WRT$)
  IF (IBSTA% AND EERR) THEN CALL gpiberr("Ibwrt Error")

' set measurement condition.
  WRT$ = "HD0;SI1;MVO,0;MA0,0;FL0;SC0;AG0"
  CALL IBWRT(dvm%, WRT$)
  IF (IBSTA% AND EERR) THEN CALL gpiberr("Ibwrt Error")

' set measurement range.
  WRT$ = "RV0,6;RA0,7"
  CALL IBWRT(dvm%, WRT$)
  IF (IBSTA% AND EERR) THEN CALL gpiberr("Ibwrt Error")

' set the function of frequency to measure.
  WRT$ = "DD7;ED1"
  CALL IBWRT(dvm%, WRT$)
  IF (IBSTA% AND EERR) THEN CALL gpiberr("Ibwrt Error")

' set communication output item.
  WRT$ = "OFD1;TO1"
  CALL IBWRT(dvm%, WRT$)
  IF (IBSTA% AND EERR) THEN CALL gpiberr("Ibwrt Error")

' wait for setting.
  FOR I% = 1 TO 10000: NEXT I%

' initialize status byte.
  WRT$ = "IM1"
  CALL IBWRT(dvm%, WRT$)
  IF (IBSTA% AND EERR) THEN CALL gpiberr("Ibwrt Error")

  CALL IBRSP(dvm%, SPR%)
  IF (IBSTA% AND EERR) THEN CALL gpiberr("Ibrsp Error")

  FOR I = 1 TO 10
    'wait finished measurement.
    SBWAIT: MASK% = &H4800
    CALL IBWAIT(dvm%, MASK%)
    IF (IBSTA% AND (EERR OR TIMO)) THEN CALL gpiberr("Ibwait Error")
    CALL IBRSP(dvm%, STB%)
    IF (IBSTA% AND EERR) THEN CALL gpiberr("Ibrsp Error")

    IF ((STB% AND &H41) <> &H41) THEN GOTO SBWAIT

  'send request measurement data.
  WRT$ = "OD"
  CALL IBWRT(dvm%, WRT$)
  IF (IBSTA% AND EERR) THEN CALL gpiberr("Ibwrt Error")

  'read measurement data.
  RD$ = SPACE$(512)
  CALL IBRD(dvm%, RD$)
  IF (IBSTA% AND EERR) THEN CALL gpiberr("Ibrd Error")

```

```

N = 0
FOR J = 1 TO 52 STEP 4
  P$ = MID$(RD$, J + 3, 1): SP = CVI(P$ + CHR$(0))
  Q$ = MID$(RD$, J + 2, 1): SQ = CVI(Q$ + CHR$(0))
  R$ = MID$(RD$, J + 1, 1): SR = CVI(R$ + CHR$(0))
  T$ = MID$(RD$, J + 0, 1): SS = CVI(T$ + CHR$(0))
  T$ = RIGHT$("0" + HEX$(SS), 2) + RIGHT$("0" + HEX$(SR), 2) + R
  IGHTE$( "0" + HEX$(SQ), 2) + RIGHT$("0" + HEX$(SP), 2)
  FOR K = 1 TO 8
    A$(K) = MID$(T$, K, 1)
    IF A$(K) = "0" THEN B$(K) = "0000"
    IF A$(K) = "1" THEN B$(K) = "0001"
    IF A$(K) = "2" THEN B$(K) = "0010"
    IF A$(K) = "3" THEN B$(K) = "0011"
    IF A$(K) = "4" THEN B$(K) = "0100"
    IF A$(K) = "5" THEN B$(K) = "0101"
    IF A$(K) = "6" THEN B$(K) = "0110"
    IF A$(K) = "7" THEN B$(K) = "0111"
    IF A$(K) = "8" THEN B$(K) = "1000"
    IF A$(K) = "9" THEN B$(K) = "1001"
    IF A$(K) = "A" THEN B$(K) = "1010"
    IF A$(K) = "B" THEN B$(K) = "1011"
    IF A$(K) = "C" THEN B$(K) = "1100"
    IF A$(K) = "D" THEN B$(K) = "1101"
    IF A$(K) = "E" THEN B$(K) = "1110"
    IF A$(K) = "F" THEN B$(K) = "1111"
  NEXT K
  B$ = B$(1) + B$(2) + B$(3) + B$(4) + B$(5) + B$(6) + B$(7) + B$(8)
  U = 0: E = 0: F = 0
  U = VAL(LEFT$(B$, 1))
  E$ = MID$(B$, 2, 8)
  FOR L = 0 TO 7
    E = E + (2 ^ L) * VAL(MID$(E$, (8 - L), 1))
  NEXT L
  W$ = MID$(B$, 10, 23)
  FOR M = 1 TO 23
    F = F + (2 ^ (-M)) * VAL(MID$(W$, M, 1))
  NEXT M
  F = F + 1
  DT(N) = ((-1) ^ U) * (2 ^ (E - 127)) * F
  IF DT(N) < 1E-12 THEN DT(N) = 0
  N = N + 1
NEXT J

PRINT "MEASURE DATA"
PRINT "ELEMENT1 : ", DT(0), DT(1), DT(2)
PRINT "ELEMENT2 : ", DT(3), DT(4), DT(5)
PRINT "ELEMENT3 : ", DT(6), DT(7), DT(8)
PRINT "SUM      : ", DT(9), DT(10), DT(11)
PRINT "FREQUENCY: ", DT(12)
PRINT

NEXT I

' Call the IBONL function to disable the hardware and software.
CALL IBONL(dvm%, 0)

END

```

## Appendix 2.1 IEEE 488.2-1987 Specifications

The GP-IB interface provided with this instrument conforms to IEEE 488.2-1987. This standard requires the following 23 points be stated in this document. This Appendix describes these points.

### (1) Subsets supported by IEEE 488.1 interface functions

Refer to page 11-1.

### (2) Operation of device when the device is assigned to an address other than addresses 0 to 30

The instrument does not allow assignment to an address other than 0 to 30.

### (3) Reaction when the user changes the address

The current address is changed when a new address is set using the INTERFACE key. The newly set address is valid until another new address is set.

### (4) Device set-up at power ON. Commands which can be used at power ON

Basically, the previous settings (i.e. the settings which were valid when power was turned OFF) are valid. All commands are available at power ON.

### (5) Message transmission options

#### (a) Input buffer size

1024 bytes

#### (b) Queries which return multiple response messages

Refer to Appendix 2.3, "Commands".

#### (c) Queries which generate response data during analysis of the syntax

Every query generates a response data when analysis of the syntax is completed.

#### (d) Queries which generate response data during reception

No query generates response data when the query is received by the controller.

#### (e) Commands consisting of parameters which restrict one other

None

### (6) Options included in command function elements and composite header elements

Refer to Appendix 2.2 and 2.3.

### (7) Buffer size which affects transmission of block data

During transmission of block data, the output queue is extended according to the size of the data blocks.

### (8) List of program data elements which can be used in equations, and nesting limit

Refer to the description of the commands given in Appendix 2.3.

### (9) Syntax of response to queries

Refer to the description of the commands given in Appendix 2.3.

### (10) Communications between devices which do not follow the response syntax

No response syntax is followed in any communication mode other than those specified in IEEE 488.2-1987 (refer to page 14-6).

### (11) Size of data block of response data

0 to 4900 bytes

### (12) List of supported common commands

Refer to Section 2.3.17, "Common Command Group".

### (13) Condition of device when calibration is successfully completed

\*CAL? is not supported.

### (14) Maximum length of block data which can be used for definition of \*DDT trigger macro

Not supported

### (15) Maximum length of macro label used in definition of macro, maximum length of block data which can be used for definition of macro, processing when recursion is used in definition of macro

Macro functions are not supported.

### (16) Response to \*IDN?

Refer to Section 2.3.17, "Common Command Group".

### (17) Size of storage area for protected user data for

\*PUD and \*PUD?

\*RDT and \*RDT? are not supported.

### (18) Length of \*RDT and \*RDT? resource name

\*RDT and \*RDT? are not supported.

### (19) Change in status due to \*RST, \*LRN?, \*RCL and \*SAV

\*RST

Refer to Section 2.3.17, "Common Command Group"

\*LRN?, \*RCL, \*SAV

These commands are not supported.

### (20) Execution range of self-test using the \*TST?

Refer to Section 2.3.17, "Common Command Group"

### (21) Structure of extended return status

Refer to Appendix 2.4.

### (22) To find out whether each command is performed in parallel or sequentially

Refer to Appendix 2.2.6, "Synchronization with the Controller" and to 2.3.

### (23) Description of execution of each command

Refer to the description of each command given in Appendix 2.3 and to their corresponding chapters.

## Appendix 2.2 Program Format

### 2.2.1 Syntax Symbols

Symbols which are used in the syntax descriptions in Appendix 2.3 are shown below. These symbols are referred to as BNF notation (Backus-Nour Form). For detailed information, refer to pages App 2-6 to 2-7.

| Symbol | Description                              | Example                     | Example             |
|--------|--|-----------------------------|---------------------|
| <x>    | Defined value                            | ELEMENT<x>                  | <x>=1~3<br>ELEMENT3 |
| { }    | { }One of the options in{ } is selected. | MODE {RMS MEAN DC}          | MODE RMS            |
|        | Exclusive OR                             | MODE {RMS MEAN DC}          | MODE RMS            |
| []     | Abbreviated                              | SCALing[:STATe] {<Boolean>} |                     |
| ...    | Repeatable                               |                             |                     |

### 2.2.2 Messages

#### Messages

Blocks of message data are transferred between the controller and this instrument during communications. Messages sent from the controller to the instrument are called program messages, and messages sent back from the instrument to the controller are called response messages.

If a program message contains a query command, i.e. a command which requests a response, the instrument returns a response message. A single response message is always returned in reply to a program message.

#### Program Messages

As explained above, the data (message) sent from the controller to the instrument is called a program message. The format of a program message is shown below.

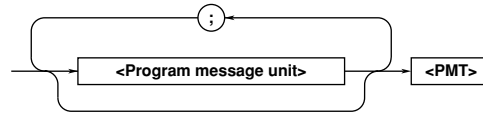

#### <Program message unit>

A program message consists of zero or more program message units; each unit corresponds to one command. The instrument executes commands one by one according to the order in which they are received.

Program message units are delimited by a ";".

For a description of the program message format, refer to the next section.

Example :CONFIGURE:VOLTAGE:RANGE 100V;MODE RMS <PMT>

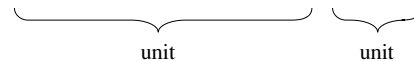

#### <PMT>

PMT is a terminator used to terminate each program message. The following three types of terminator are available.

- NL (New Line) : Same as LF (Line Feed). ASCII code "0AH" is used.
- ^END : END message defined in IEEE488.1. (EOI signal)  
(The data byte sent with an END message will be the final item of the program message.)
- NL^END : NL with an END message attached (NL is not included in the program message.)

**• Program message unit format**

The format of a program message unit is shown below.

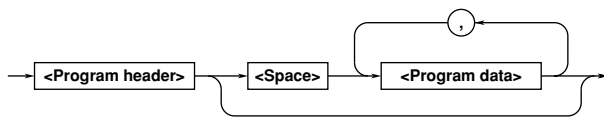

**<Program header>**

A program header is used to indicate the command type. For details, refer to page App 2-4.

**<Program data>**

If certain conditions are required for the execution of a command, program data must be added. Program data must be separated from the header by a space (ASCII code "20H"). If multiple items of program data are included, they must be separated by a "," (comma).

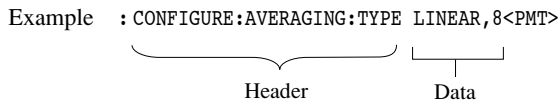

**Response Message**

The data returned by the instrument to the controller is called a response message. The format of a response message is shown below.

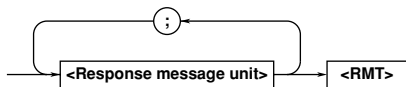

**<Response message units>**

A response message consists of one or more response message units: each response message unit corresponds to one response.

Response message units are delimited by a ";".

For the response message format, refer to the next section.

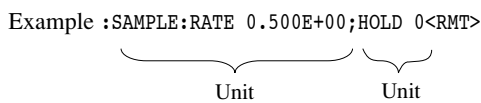

**<RMT>**

RMT is the terminator used for every response message. Only one type of response message is available; NL^END.

**• Response message unit format**

The format of a program message unit is shown below.

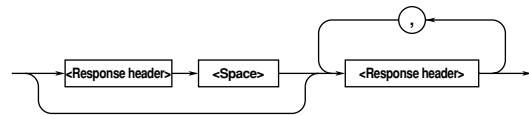

**<Response header>**

A response header sometimes precedes the response data. Response data must be separated from the header by a space. For details, refer to page App 2-6.

**<Response data>**

Response data is used to define a response. If multiple items of response data are used, they must be separated by a "," (comma).

Example 500.0E-03<RMT>

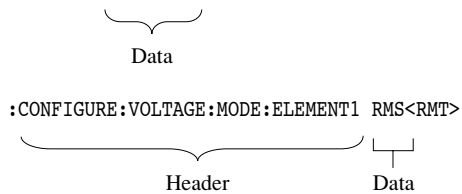

If a program message contains more than one query, responses are made in the same order as the queries. Normally, each query returns only one response message unit, but there are some queries which return more than one response message unit. The first response message unit always responds to the first query, but it is not always true that the 'n'th unit always responds to the 'n'th query. Therefore, if you want to make sure that a response is made to each query, the program message must be divided up into individual messages.

**Points to Note when Sending/Receiving Messages**

- If the previous message contained a query, it is not possible to send another program message until a response message has been received.
- An error will occur if a program message is sent before a response message has been received in its entirety. A response message which has not been received will be discarded.
- If an attempt is made by the controller to receive a response message, even if there is no response message, an error will occur. An error will also occur if the controller makes an attempt to receive a response message before transmission of a program message has been completed.
- If a program message of more than one unit is sent and some of the units are incomplete, the instrument receives program message units which the instrument thinks complete and attempts to execute them. However, these attempts may not always be successful and a response may not always be returned, even if the program message contains queries.

**Dead Lock**

The instrument has a buffer memory in which both program and response messages of 1024 bytes or more can be stored. (The number of bytes available will vary depending on the operating state of the instrument.) If both buffer memories become full at the same time, the instrument becomes inoperative. This state is called dead lock. In this case, operation can be resumed by discarding the response message.

No dead lock will occur, if the size of the program message including the PMT is kept below 1024 bytes. Furthermore, no dead lock will occur if the program message does not contain a query.

**2.2.3 Commands**

**Commands**

There are three two of command (program header) which can be sent from the controller to the instrument. They differ in the format of their program headers.

**Common Command Header**

Commands defined in IEEE 488.2-1987 are called common commands. The header format of a common command is shown below. An asterisk (\*) must always be attached to the beginning of a command.

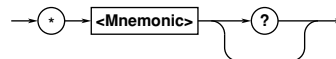

An example of a common command

: \*CLS

**Compound Header**

Commands designed to be used only with the instrument are classified and arranged in a hierarchy according to their function. The format of a compound header is illustrated below. A colon (:) must be used when specifying a lower-level header.

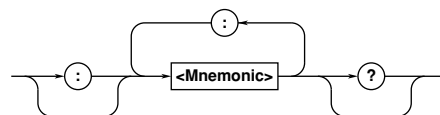

An example of a compound header

: CONFIGURE : VOLTAGE : MODE : ELEMENT1 RMS

**Note**

- A mnemonic is a character string made up of alphanumeric characters.

**When Concatenating Commands**

• **Command Group**

A command group is a group of commands which have the same compound header. A command group may contain sub-groups.

Example Commands relating to integration

- INTEGrate?
- INTEGrate:MODE
- INTEGrate:RTIME?
- INTEGrate:RTIME:START
- INTEGrate:RTIME:STOP
- INTEGrate:TIMer
- INTEGrate:POLarity
- INTEGrate:START
- INTEGrate:STOP
- INTEGrate:RESet

### • When Concatenating Commands of the Same Group

This instrument stores the hierarchical level of the command which is currently being executed, and performs analysis on the assumption that the next command to be sent will also belong to the same level. Therefore, it is possible to omit the header if the commands belong to the same group.

Example `DISPLAY1:FUNCTION V;ELEMENT 1<PMT>`

### • When Concatenating Commands of Different Groups

A colon (:) must be included before the header of a command, if the command does not belong to the same group as the preceding command.

Example `DISPLAY1:FUNCTION V;:SAMPLE:HOLD ON<PMT>`

### • When Concatenating Common Commands

Common commands defined in IEEE 488.2-1987 are independent of hierarchical level. Thus, it is not necessary to add a colon (:) before a common command.

Example `DISPLAY1:FUNCTION V;*CLS:ELEMENT 1<PMT>`

### • When Separating Commands with <PMT>

If a terminator is used to separate two commands, each command is a separate message. Therefore, the common header must be typed in for each command even when commands of the same command group are being concatenated.

Example `DISPLAY1:FUNCTION V<PMT>DISPLAY1:ELEMENT 1<PMT>`

## Upper-level Query

An upper-level query is the highest-level command of a group to which a question mark is appended. Execution of an upper-level query allows all a group's settings to be output at once. Some query groups comprising more than three hierarchical levels can output all their lower level settings.

Example `SAMPLE?<PMT>→  
:SAMPLE:RATE 0.500E+00;HOLD 0`

In reply to an upper-level query, a response can be returned as a program message to the instrument.

## Header Interpretation Rules

The instrument interprets the header received according to the following rules.

- Mnemonics are not case sensitive.

Example `"FUNction"` can be written as `"function"` or `"Function"`.

- The lower-case part of a header can be omitted.

Example `"FUNction"` can be written as `"FUNCT"` or `"FUNC"`.

- If the header ends with a question mark, the command is a query. It is not possible to omit the question mark.

Example `"FUNction?"` cannot be abbreviated to anything shorter than `"FUNC?"`.

- If the "x" at the end of a mnemonic is omitted, it is assumed to be "1".

Example If `"ELEMENT<x>"` is written as `"ELEM"`, this represents `"ELEMENT1"`.

- Any part of a command enclosed by [ ] can be omitted.

Example `[CONFigure]:SCALing[:STATe] ON` can be written as `SCAL ON`.

However, a part enclosed by [ ] cannot be omitted if is located at the end of an upper-level query.

Example `"SCALing?"` and `"SCALing:STATe?"` belong to different query levels.



## 2.2.4 Response

On receiving a query from the controller, the instrument returns a response message to the controller. A response message is sent in one of the following two forms.

- Response consisting of a header and data  
If the query can be used as a program message without any change, a command header is attached to the query, which is then returned.

Example    `INTEGRATE:MODE?<PMT> →  
              : INTEGRATE:MODE NORMAL<RMT>`

- Response consisting of data only  
If the query cannot be used as a program message unless changes are made to it (i.e. it is a query-only command), no header is attached and only the data is returned. Some query-only commands can be returned after a header is attached to them.

Example    `STATUS:ERROR?<PMT> → 0, "NO ERROR"<RMT>`

### • When returning a response without a header

It is possible to remove the header from a response consisting of a header and data. The "`COMMUNICATE:HEADER`" command is used to do this.

### • Abbreviated form

Normally, a response header is returned with the lower-case part removed. It is also possible to return a response header in full form, without the lower-case part removed. The "`COMMUNICATE:VERBOSE`" command is used to do this. The part enclosed by [ ] is also omitted in the abbreviated form.

## 2.2.5 Data

### Data

A data section comes after the header. A space must be included between the header and the data. The data contains conditions and values. Data is classified as below.

| Data  | Description  |
|---|--|
| <Decimal><br>(Example    PT ratio setting → <code>CONFIGURE:SCALING:PT 100</code> )                               | Decimal number   |
| <Voltage><br><Time><Frequency><br>(Example    Voltage range → <code>CONFIGURE:VOLTAGE:RANGE 150V</code> )         | Physical value   |
| <Register><br>(Example    Extended event register value → <code>STATUS:EESE #HFE</code> )                         | Register value expressed as either binary, octal, decimal or hexadecimal |
| <Character data><br>(Example    Measuring mode → <code>CONFIGURE:MODE {RMS MEAN DC}</code> )                      | Specified character string(mnemonic).<br>Can be selected from { }.       |
| <Boolean><br>(Example    Averaging ON → <code>CONFIGURE:AVERAGING[:STATE] ON</code> )                             | Indicates ON/OFF. Set to ON, OFF or value                                |
| <Character string data><br>(Example    Character string expressing time → <code>INTEGRATE:TIMER "100:00"</code> ) | Arbitrary character string   |
| <Block data><br>(Example    Response to measured/computed data → <code>#40012ABCDEFGHIJKL</code> )                | Arbitrary 32 bit data  |

### <Decimal>

<Decimal> indicates a value expressed as a decimal number, as shown in the table below. Decimal values are given in the NR form specified in ANSI X3. 42-1975.

| Symbol | Description                                 | Example              |
|--------|---|----------------------|
| <NR1>  | Integer                                     | 125 -1 +1000         |
| <NR2>  | Fixed point number                          | 125.0 -.90 +001.     |
| <NR3>  | Floating point number                       | 125.0E+0 -9E-1 +.1E4 |
| <NRf>  | Any of the forms <NR1> to <NR3> is allowed. |                      |

- Decimal values which are sent from the controller to the instrument can be sent in any of the forms <NR1> to <NR3>. In this case, <NRf> appears.
- For response messages which are returned from the instrument to the controller, the form (<NR1> to <NR3> to be used) is determined by the query. The same form is used, irrespective of whether the value is large or small.
- In the case of <NR3>, the "+" after the "E" can be omitted, but the "-" cannot.
- If a value outside the setting range is entered, the value will be normalized so that it is just inside the range.
- If the value has more than the significant number of digits, the value will be rounded.

### <Voltage>, <Current>, <Frequency>, <Time>

<Voltage>, <Current>, <Frequency> and <Time> indicate decimal values which have physical significance. <Multiplier> or <Unit> can be attached to <NRf>. They can be entered in any of the following forms.

| Form                    | Example |
|-------------------------|---------|
| <NRf><Multiplier><Unit> | 5MV     |
| <NRf><Unit>             | 5E-3V   |
| <NRf><Multiplier>       | 5M      |
| <NRf>                   | 5E-3    |

**<Multiplier>**

Multipliers which can be used are shown below

| Symbol | Word  | Description       |
|--------|-------|-------------------|
| EX     | Exa   | 10 <sup>18</sup>  |
| PE     | Peta  | 10 <sup>15</sup>  |
| T      | Tera  | 10 <sup>12</sup>  |
| G      | Giga  | 10 <sup>9</sup>   |
| MA     | Mega  | 10 <sup>6</sup>   |
| K      | Kilo  | 10 <sup>3</sup>   |
| M      | Milli | 10 <sup>-3</sup>  |
| U      | Micro | 10 <sup>-6</sup>  |
| N      | Nano  | 10 <sup>-9</sup>  |
| P      | Pico  | 10 <sup>-12</sup> |
| F      | Femto | 10 <sup>-15</sup> |

**<Unit>**

Units which can be used are shown below. Symbol Word Description

| Symbol | Word      | Description   |
|--------|-----------|---------------|
| V      | Volt      | Voltage       |
| A      | Ampere    | Current       |
| HZ     | Hertz     | Frequency     |
| MHZ    | Megahertz | Frequency     |
| S      | Second    | Time (second) |

- <Multiplier> and <Unit> are not case sensitive.
- "U" is used to indicate "µ".
- "MA" is used for Mega (M) to distinguish it from Milli, except for in the case of Milli ampere and Megahertz, which is expressed as "MA" and "MHZ". Hence, it is not permissible to use "M" (Milli) for Hertz.
- If both <Multiplier> and <Unit> are omitted, the fundamental unit (V, A, HZ, S) will be used.
- Response messages are always expressed in <NR3> form. Neither <Multiplier> nor <Unit> is used.

**<Register>**

<Register> indicates an integer, and can be expressed in hexadecimal, octal or binary as well as a decimal number. <Register> is used when each bit of a value has a particular meaning. <Register> is expressed in one of the following forms.

| Form  | Example  |
|---|----------|
| <NRf>   | 1        |
| #H<Hexadecimal value made up of the digits 0 to 9 and A to F> | #H0F     |
| #Q<Octal value made up of the digits 0 to 7>                  | #q777    |
| #B<Binary value made up of the digits 0 and 1>                | #B001100 |

- <Register> is not case sensitive.
- A response message is always <NR1>.

**<Character Data>**

<Character data> is a specified string of character data (a mnemonic). It is mainly used to indicate options, and is chosen from the character strings given in { }. For interpretation rules, refer to "Header Interpretation Rules" on page App 2-6.

| Form          | Example |
|---------------|---------|
| {RMS MEAN DC} | RMS     |

- As with a header, the "COMMunicate:VERBoSe" command can be used to select whether a response message is returned in its full form or abbreviated form.
- "COMMunicate:HEADer" does not affect <character data>.

**<Boolean>**

<Boolean> is data which indicates ON or OFF, and is expressed in one of the following forms.

| Form           | Example    |
|----------------|------------|
| {ON OFF <NRf>} | ON OFF 1 0 |

- When <Boolean> is expressed in <NRf> form, OFF is selected if the rounded integer value is "0" and ON is selected if the rounded integer is "Not 0".
- A response message is always "1" if the value is ON and "0" if it is OFF.

**<Character String Data>**

<Character string data> is not a specified character string like <character data>. It is an arbitrary character string. A character string must be enclosed in single quotation marks (') or double quotation marks (").

| Form                    | Example                |
|-------------------------|------------------------|
| <Character string data> | 'ABC' "IEEE488.2-1987" |

- If a character string contains a double quotation mark ("), the double quotation mark will be replaced by two concatenated double quotation marks (" "). This rule also applies to a single quotation mark within a character string.
- A response message is always enclosed by double quotation marks (").
- <Character string data> is an arbitrary character string, therefore the instrument assumes that the remaining program message units are part of the character string if no single (') or double quotation mark (") is encountered. As a result, no error will be detected if a quotation mark is omitted.

**<Block data>**

<Block data> is arbitrary 32-bit data. On the instrument, <Block data> is only used for response messages. Block data is expressed in the following form.

| Form  | Example           |
|---|-------------------|
| #4<4-digit decimal value><Data byte string> | #40012ABCDEFHIJKL |

- #4  
Indicates that the data is <Block data>.
- <4-digit decimal value>  
Indicates the number of bytes of data. (0012 = 12 bytes)
- <Data byte string>  
The actual data. (ABCDEFHIJKL)
- Data is comprised of 32-bit values (0 to 4294967295). This means that the ASCII code "0AH", which stands for "NL", can also be a code used for data. Hence, care must be taken when programming the controller.

## 2.2.6 Synchronization with the Controller

There are two kinds of command; overlap commands and sequential commands. Overlap commands, which are allowed to be executed before execution of the previously sent command is completed, are not supported by this instrument. In the case of sequential commands, which are supported by this instrument, the instrument delays execution of a command until execution of the previously sent command is completed. However, synchronization is sometimes required for correct inquiry for measured data, even if a sequential command is used.

For instance, if a program message is sent when an inquiry about measured data is made immediately after the voltage range is changed, the "MEASure:VALue?" command will be executed whether update of the measured data has been completed or not and no data is displayed ("-----" is displayed instead), possibly causing "9.91E+37 (Not A Number)" to be output.

```
[ C O N F i g u r e : ] V O L T a g e : R A N G e [ : A L L ]
60V ; : M E A S u r e : V A L u e ? < P M T >
```

In this case, synchronization with the time at which update of measured data is completed must be accomplished, as shown on the next page.

### • Using STATUS:CONDition? query

A "STATUS:CONDition?" query is used to make an inquiry about the contents of the condition register (page App 2-59). It is possible to judge whether update of measured data is in progress or not by reading bit 0 of the condition register. Bit 0 is "1" if update is in progress, and "0" if update is stopped therefore making an inquiry is possible.

### • Using the extended event register

Changes in the condition register are reflected in the extended event register (page App 2-59).

```
Example  S T A T u s : F I L T e r 1  F A L L ; : S T A T u s : E E S E
1 ; E E S R ? ; * S R E 8 ; [ : C O N F i g u r e ] : V O L T a g e
: R A N G e [ : A L L ] 60V < P M T >
(Service request is awaited.)
M E A S u r e : V A L u e ? < P M T >
```

"STATUS:FILTer1 FALL" indicates that the transit filter is set so that bit 0 (FILTer1) is set to "1" when bit 0 of the condition register is changed from "1" to "0".

"STATUS:EESE 1" is a command used to reflect the status of bit 0 of the extended event register in the status byte.

"STATUS:EESR?" is used to clear the extended event register.

The "\*SRE" command is used to generate a service request caused solely by the extended event register.

"MEASure:VALue?" will not be executed until a service request is generated.

### • Using the COMMunicate:WAIT command

The "COMMunicate:WAIT" command halts communications until a specific event is generated.

```
Example  S T A T u s : F I L T e r 1  F A L L ; : S T A T u s : E E S R ?
; [ : C O N F i g u r e ] : V O L T a g e : R A N G e
[ : A L L ] 60V < P M T >
(Response to STATUS:EESR? is decoded.)
C O M M u n i c a t e : W A I T 1 ; : M E A S u r e
: V A L u e ? < P M T >
```

For a description of "STATUS:FILTer FALL" and "STATUS:EESR?", refer to "Using the extended event register" on this page.

"COMMunicate:WAIT 1" means that communications is halted until bit 0 of the extended event register is set to "1".

"MEASure:VALue" will not be executed until bit 0 of the extended event register is set to "1".

## 2.3 Commands

### 2.3.1 Command List

| Command                                      | Function  | Reference Page |
|--|---|----------------|
| <b>AOUTput Group</b>                         |   |                |
| :AOUTput?                                    | Queries all the current D/A output settings.  | App 2-14       |
| :AOUTput:HARMonics?                          | Queries all the current D/A output item settings for harmonic analysis mode.  | App 2-14       |
| :AOUTput:HARMonics:CHANnel<x>                | Sets D/A output items for the specified channel for harmonic analysis mode/queries the current setting.                     | App 2-15       |
| :AOUTput:HARMonics:PRESet                    | Sets D/A output items for harmonic analysis mode at once.   | App 2-15       |
| :AOUTput:NORMal?                             | Queries all the current D/A output item settings for normal measurement mode.   | App 2-15       |
| :AOUTput:NORMal:CHANnel<x>                   | Sets D/A output items for the specified channel for normal measurement mode/queries the current setting.                    | App 2-15       |
| :AOUTput:NORMal:IRTime                       | Sets the rated integration time for D/A output of integrated values /queries the current setting.                           | App 2-15       |
| :AOUTput:NORMal:PRESet                       | Sets D/A output items for normal measurement mode at once.  | App 2-15       |
| <b>COMMunicate Group</b>                     |   |                |
| :COMMunicate?                                | Queries all the communications settings.  | App 2-16       |
| :COMMunicate:HEAdEr                          | Determines whether a header is to be added or not.  | App 2-16       |
| :COMMunicate:LOCKout                         | Turns the local lock out function ON or OFF.  | App 2-16       |
| :COMMunicate:REMOte                          | Selects remote mode or local mode.  | App 2-16       |
| :COMMunicate:STATus?                         | Queries the current network status.   | App 2-17       |
| :COMMunicate:VERBOse                         | Determines whether a response to a query is to be returned in full form or in abbreviated form/queries the current setting. | App 2-17       |
| :COMMunicate:WAIT                            | Waits until one of the specified extended event occurs.   | App 2-17       |
| :COMMunicate:WAIT?                           | Generates a response when one of the specified extended events occurs.  | App 2-17       |
| <b>CONFigure Group</b>                       |   |                |
| :CONFigure?                                  | Queries all the measurement condition settings.   | App 2-20       |
| [ :CONFigure]:AVERaging?                     | Queries all the averaging function settings.  | App 2-20       |
| [ :CONFigure]:AVERaging[ :STATe]             | Turns the averaging function ON or OFF/queries the current setting.   | App 2-20       |
| [ :CONFigure]:AVERaging:TYPE                 | Sets the averaging type/queries the current setting.  | App 2-20       |
| [ :CONFigure]:CFACtor                        | Sets the crest factor/queries the current setting.  | App 2-20       |
| [ :CONFigure]:CURRent?                       | Queries all the current measurement settings  | App 2-20       |
| [ :CONFigure]:CURRent:AUTO?                  | Queries all the auto range settings for the current range.  | App 2-20       |
| [ :CONFigure]:CURRent:AUTO[ :ALL]            | Sets current auto range ON or OFF for all the elements at once.   | App 2-20       |
| [ :CONFigure]:CURRent:AUTO:ELEMent<x>        | Sets current auto range ON or OFF for the specified element/queries the current setting.                                    | App 2-21       |
| [ :CONFigure]:CURRent:ESCaling?              | Queries external sensor scaling constant for each element.  | App 2-21       |
| [ :CONFigure]:CURRent:ESCaling[ :ALL]        | Sets external sensor scaling constant for all the elements at once.   | App 2-21       |
| [ :CONFigure]:CURRent:ESCaling:ELEMent<x>    | Sets external sensor scaling constant for the specified element/queries the current setting.                                | App 2-21       |
| [ :CONFigure]:CURRent:MODE?                  | Queries current measurement mode for each element.  | App 2-21       |
| [ :CONFigure]:CURRent:MODE[ :ALL]            | Sets current measurement mode for all the elements at once.   | App 2-21       |
| [ :CONFigure]:CURRent:MODE:ELEMent<x>        | Sets current measurement mode for the specified element/queries the current setting.  | App 2-21       |
| [ :CONFigure]:CURRent:RANGe?                 | Queries current range for each element.   | App 2-21       |
| [ :CONFigure]:CURRent:RANGe[ :ALL]           | Sets current range for all the elements at once.  | App 2-21       |
| [ :CONFigure]:CURRent:RANGe:ELEMent<x>       | Sets current range for the specified element/queries the current setting.   | App 2-21       |
| [ :CONFigure]:DEGRee                         | Sets phase angle display method/queries the current setting   | App 2-22       |
| [ :CONFigure]:FILTEr?                        | Queries the current line filter setting.  | App 2-22       |
| [ :CONFigure]:FILTEr:CUToFF                  | Sets line filter cut-off frequency/queries the current setting.   | App 2-22       |
| [ :CONFigure]:FILTEr[ :STATe]                | Turns the line filter ON or OFF/queries the current setting.  | App 2-22       |
| [ :CONFigure]:FREQUency?                     | Queries the current frequency setting.  | App 2-22       |
| [ :CONFigure]:FREQUency:FILTEr               | Turns the frequency filter ON or OFF/queries the current setting.   | App 2-22       |
| [ :CONFigure]:NULL?                          | Queries all the NULL function settings.   | App 2-22       |
| [ :CONFigure]:NULL[ :DC]                     | Turns the NULL function ON or OFF/queries the current setting.  | App 2-22       |
| [ :CONFigure]:PHOLD?                         | Queries all the peak hold settings.   | App 2-22       |
| [ :CONFigure]:PHOLD:FUNCTion                 | Sets the peak hold function/queries the current setting.  | App 2-22       |
| [ :CONFigure]:PHOLD[ :STATe]                 | Turns the peak hold function ON or OFF/queries the current setting.   | App 2-22       |
| [ :CONFigure]:SCALing?                       | Queries all the current scaling function settings.  | App 2-22       |
| [ :CONFigure]:SCALing:{PT CT SFACTor}?       | Queries the current scaling constant (voltage, current, power) for each element.  | App 2-22       |
| [ :CONFigure]:SCALing:{PT CT SFACTor}[ :ALL] | Sets scaling constant (voltage, current, power) for all the elements at once.   | App 2-22       |

## Appendix 2.3 Commands

| Command   | Function  | Reference Page |
|---|---|----------------|
| [ :CONFIgure ] :SCALing : {PT   CT   SFACTOR } :ELEMEnt <x> | Sets scaling constant (voltage, current, power) for the specified element.  | App 2-23       |
| [ :CONFIgure ] :SCALing [ :STATe ]                          | Turns the scaling function ON or OFF/queries the current setting.   | App 2-23       |
| [ :CONFIgure ] :VOLTage ?                                   | Queries all the voltage measurement settings.   | App 2-23       |
| [ :CONFIgure ] :VOLTage :AUTO ?                             | Queries all the auto range settings for the voltage range.  | App 2-23       |
| [ :CONFIgure ] :VOLTage :AUTO [ :ALL ]                      | Sets voltage auto range ON or OFF for all the elements at once.   | App 2-23       |
| [ :CONFIgure ] :VOLTage :AUTO :ELEMEnt <x>                  | Sets voltage auto range ON or OFF for the specified element/queries the current setting.  | App 2-23       |
| [ :CONFIgure ] :VOLTage :MODE ?                             | Queries voltage measurement mode for each element.  | App 2-23       |
| [ :CONFIgure ] :VOLTage :MODE [ :ALL ]                      | Sets voltage measurement mode for all the elements at once.   | App 2-23       |
| [ :CONFIgure ] :VOLTage :MODE :ELEMEnt <x>                  | Sets voltage measurement mode for the specified element/queries the current setting.  | App 2-23       |
| [ :CONFIgure ] :VOLTage :RANGe ?                            | Queries voltage range for each element  | App 2-23       |
| [ :CONFIgure ] :VOLTage :RANGe [ :ALL ]                     | Sets voltage range for all the elements at once.  | App 2-23       |
| [ :CONFIgure ] :VOLTage :RANGe :ELEMEnt <x>                 | Sets voltage range for the specified element/queries the current setting.   | App 2-23       |
| [ :CONFIgure ] :WIRing                                      | Sets wiring system/queries the current setting.   | App 2-24       |
| <b>DISPlay Group</b>  |   |                |
| :DISPlay <x> ?  | Queries all the current display settings for the specified display.   | App 2-24       |
| :DISPlay <x> :ELEMEnt                                       | Sets the element to be displayed/queries the current setting.   | App 2-24       |
| :DISPlay <x> :FUNCTion                                      | Sets the function to be displayed/queries the current setting.  | App 2-24       |
| <b>FLICKer Group</b>  |   |                |
| :FLICKer ?  | Queries all the flicker measurement settings.   | App 2-26       |
| :FLICKer :COUNT   | Sets the number of times measurement of short-term flicker value Pst is to be performed/queries the current setting.  | App 2-26       |
| :FLICKer :DC ?  | Queries all the relative steady-state voltage change (dc) settings.   | App 2-26       |
| :FLICKer :DC :LIMit   | Sets the limit for relative steady-state voltage change dc/queries the current setting.   | App 2-27       |
| :FLICKer :DC [ :STATe ]                                     | Sets judgment ON or OFF for relative steady-state voltage change dc/queries the current setting.  | App 2-27       |
| :FLICKer :DISPlay ?   | Queries all the flicker measurement display settings.   | App 2-27       |
| :FLICKer :DISPlay :ELEMEnt                                  | Sets the element to be displayed during flicker measurement mode/queries the current setting.   | App 2-27       |
| :FLICKer :DISPlay :FUNCTion                                 | Sets the function to be displayed during flicker measurement mode/queries the current setting.  | App 2-27       |
| :FLICKer :DISPlay :PERiod                                   | Sets the flicker observation period no. (display A) for flicker measurement/queries the current setting.  | App 2-27       |
| :FLICKer :DMAX ?  | Queries all the maximum relative voltage change dmax settings.  | App 2-27       |
| :FLICKer :DMAX :LIMit                                       | Sets the limit for maximum relative voltage change dmax/queries the current setting.  | App 2-27       |
| :FLICKer :DMAX [ :STATe ]                                   | Sets judgment ON or OFF for maximum relative voltage change dmax/queries the current setting.   | App 2-27       |
| :FLICKer :DIMIN ?   | Queries all the steady-state range dmin settings.   | App 2-27       |
| :FLICKer :DIMIN :LIMit                                      | Sets the limit for steady-state range dmin/queries the current setting.   | App 2-27       |
| :FLICKer :DT ?  | Queries all the settings regarding the period d (t) <sub>200 ms</sub> during which voltage exceeds the threshold level within one voltage fluctuation.                                    | App 2-27       |
| :FLICKer :DT :LIMit   | Sets the limit for the period d (t) <sub>200 ms</sub> during which relative voltage change exceeds the threshold level during a voltage fluctuation/queries the current setting.          | App 2-27       |
| :FLICKer :DT [ :STATe ]                                     | Sets judgment ON or OFF for the period d (t) <sub>200 ms</sub> during which relative voltage change exceeds the threshold level during a voltage fluctuation/queries the current setting. | App 2-28       |
| :FLICKer :ELEMEnt <x>                                       | Sets the element for which flicker measurement is to be performed/queries the current setting.  | App 2-28       |
| :FLICKer :INITialize  | Initializes measurement of voltage fluctuation.   | App 2-28       |
| :FLICKer :INTerval  | Sets the time required for measurement of short-term flicker value Pst/queries the current setting.   | App 2-28       |
| :FLICKer :PLT ?   | Queries all the long-term flicker value Plt settings/queries the current setting.   | App 2-28       |
| :FLICKer :PLT :LIMit  | Sets the limit for long-term flicker value Plt/queries the current setting.   | App 2-28       |
| :FLICKer :PLT :NVALue                                       | Sets N value for long-term flicker value Plt (constant used in Plt equation)/queries the current setting.   | App 2-28       |
| :FLICKer :PLT [ :STATe ]                                    | Sets judgment ON or OFF for long-term flicker value Plt/queries the current setting.  | App 2-28       |
| :FLICKer :PST ?   | Queries all the short-term flicker value Pst settings/queries the current setting.  | App 2-28       |
| :FLICKer :PST :LIMit  | Sets the limit for short-term flicker value Pst/queries the current setting.  | App 2-28       |
| :FLICKer :PST [ :STATe ]                                    | Sets judgment ON or OFF for short-term flicker value Pst/queries the current setting.   | App 2-28       |
| :FLICKer :START   | Starts measurement of voltage fluctuation.  | App 2-28       |
| :FLICKer [ :STATe ]   | Turns flicker measurement mode ON or OFF/queries the current setting.   | App 2-28       |
| :FLICKer :STOP  | Stops measurement of voltage fluctuation.   | App 2-29       |
| :FLICKer :UN ?  | Queries all the nominal voltage Un settings.  | App 2-29       |
| :FLICKer :UN :MODE  | Sets the acquisition method for nominal voltage Un/queries the current setting.   | App 2-29       |
| :FLICKer :UN :VALue   | Sets the existing value for nominal voltage Un/queries the current setting.   | App 2-29       |

| Command   | Function  | Reference Page |
|---|---|----------------|
| <b>HARMonics Group</b>  |   |                |
| :HARMonics?   | Queries all the harmonic analysis settings.   | App 2-30       |
| :HARMonics:DISPlay?   | Queries all the display settings for harmonic analysis.   | App 2-30       |
| :HARMonics:DISPlay:MODE   | Sets display mode for harmonic analysis items to be displayed on display B/queries the current setting.                                     | App 2-30       |
| :HARMonics:DISPlay:ORDER  | Sets harmonic order to be displayed on display A/queries the current setting.   | App 2-31       |
| :HARMonics:FILTer   | Turns anti-aliasing filter for harmonic analysis ON or OFF/queries the current setting.   | App 2-31       |
| :HARMonics:ORDER  | Sets the maximum harmonic order for harmonic analysis /queries the current setting.   | App 2-31       |
| :HARMonics[:STATe]  | Turns harmonic analysis mode ON or OFF/queries the current setting.   | App 2-31       |
| :HARMonics:SYNChronize  | Sets the input to be used as the fundamental frequency for PLL  | App 2-31       |
| :HARMonics:THD  | Synchronization/queries the current setting.  | App 2-31       |
| :HARMonics:WINDow   | Sets the window width for harmonic analysis/queries the current setting.  | App 2-31       |
| <b>INTEGrate Group</b>  |   |                |
| :INTEGrate?   | Queries all the integration settings.   | App 2-32       |
| :INTEGrate:MODE   | Sets integration mode/queries the current setting.  | App 2-32       |
| :INTEGrate:POLarity   | Sets polarity of integrated values to be displayed on display D/queries the current setting.  | App 2-32       |
| :INTEGrate:RESet  | Resets integrated values.   | App 2-32       |
| :INTEGrate:RTIME?   | Queries the integration start and stop time for real time counting .<br>integration mode  | App 2-32       |
| :INTEGrate:RTIME:STARt  | Sets the integration start time for real time counting integration mode<br>/queries the current setting.                                    | App 2-33       |
| :INTEGrate:RTIME:STOP   | Sets the integration stop time for real time counting integration mode<br>/queries the current setting.                                     | App 2-33       |
| :INTEGrate:STARt  | Starts integration.   | App 2-33       |
| :INTEGrate:STOP   | Stops integration.  | App 2-33       |
| :INTEGrate:TImer  | Sets integration timer preset time/queries the current setting.   | App 2-33       |
| <b>MATH Group</b>   |   |                |
| :MATH?  | Queries all the computation settings.   | App 2-34       |
| :MATH:ARITHmetic  | Sets equation for four arithmetical operations/queries the current setting.   | App 2-34       |
| :MATH:CFACtor   | Sets equation for crest factor/queries the current setting.   | App 2-34       |
| :MATH:TYPE  | Sets computation type/queries the current setting.  | App 2-34       |
| <b>MEASure Group</b>  |   |                |
| :MEASure?   | Queries all the settings for measured/computed data for communication output.   | App 2-36       |
| :MEASure:FLICkEr:CPF<x>?  | Queries the CPF (cumulative probability function) data obtained during the<br>previous flicker observation period.                          | App 2-36       |
| :MEASure:FLICkEr:JUDGe<x>?                                      | Queries the judgment result data for each flicker observation period.   | App 2-36       |
| :MEASure:FORMat   | Sets communication output format for measured/computed data<br>/queries the current setting.  | App 2-36       |
| :MEASure:ITEM?  | Queries all the communication output items settings for measured/computed data.   | App 2-36       |
| :MEASure:ITEM:FLICkEr?  | Queries all the communication output items for flicker measurement.   | APP 2-37       |
| :MEASure:ITEM:FLICkEr<flicker measurement function>?            | Queries all the communication output settings for the specified flicker measurement function.   | App 2-37       |
| :MEASure:ITEM:FLICkEr<flicker measurement function>:[ALL]       | Turns communication output for the specified flicker measurement function<br>ON or OFF for all the elements at once.                        | App 2-37       |
| :MEASure:ITEM:FLICkEr<flicker measurement function>:ELEMEnt<x>  | Turns communication output for the specified flicker measurement function<br>ON or OFF for the specified element.                           | App 2-37       |
| :MEASure:ITEM:FLICkEr:TIME                                      | Turns communication output of the elapsed time of voltage fluctuation<br>measurement ON or OFF/queries the current setting.                 | App 2-37       |
| :MEASure:ITEM:FLICkEr:PRESet                                    | Turns communication output ON or OFF for all the flicker measurement functions at once.   | App 2-37       |
| :MEASure:ITEM:HARMonics?  | Queries all the communication output items for harmonic analysis mode.  | App 2-37       |
| :MEASure:ITEM:HARMonics:<Harmonic analysis function>?           | Queries all the communication output settings for the specified harmonic<br>analysis function.  | App 2-37       |
| :MEASure:ITEM:HARMonics:{<Harmonic analysis function>}:[ALL]    | Turns communication output for the specified harmonic analysis function<br>ON or OFF for all the elements at once.                          | App 2-38       |
| :MEASure:ITEM:HARMonics:<Harmonic analysis function>:ELEMEnt<x> | Turns communication output for the specified harmonic analysis function<br>ON or OFF for the specified element/queries the current setting. | App 2-38       |
| :MEASure:ITEM:HARMonics:<Harmonic analysis function>:SIGMa      | Turns communication output of w data ON of OFF for the<br>specified harmonic analysis function/queries the current setting.                 | App 2-38       |

## Appendix 2.3 Commands

| Command   | Function  | Reference Page |
|---|---|----------------|
| :MEASure:ITEM:HARMonics:SYNChronize                             | Turns communication output for PLL source ON or OFF/queries the current setting.  | App 2-38       |
| :MEASure:ITEM:HARMonics:PRESet                                  | Turns communication output ON or OFF for all the harmonic analysis functions at once.   | App 2-38       |
| :MEASure:ITEM:NORMal?   | Queries all the communication output items for normal measurement data.   | App 2-38       |
| :MEASure:ITEM[:NORMal]:<Normal measurement function>?           | Queries all the communication output items for the specified normal measurement function.   | App 2-38       |
| :MEASure:ITEM[:NORMal]:<Normal measurement function>[:ALL]      | Turns communication output ON or OFF for the specified normal measurement function for all the elements at once.  | App 2-39       |
| :MEASure:ITEM[:NORMal]:<Normal measurement function>:ELEMEnt<x> | Turns communication output ON or OFF for the specified normal measurement function for the specified element.   | App 2-39       |
| :MEASure:ITEM[:NORMal]:<Normal measurement function>:SIGMa      | Turns communication output of $\Sigma$ data ON or OFF for the specified normal measurement function/queries the current setting.                                    | App 2-39       |
| :MEASure:ITEM[:NORMal]:{TIME FREQuency MATH}                    | Turns communication output ON or OFF for the normal measurement functions (elapsed time of integration, frequency, computation)/queries the current setting.        | App 2-39       |
| :MEASure:ITEM[:NORMal]:PRESet                                   | Sets communication output items for normal measurement mode to the preset settings at once.   | App 2-39       |
| :MEASure:VALue?   | Queries the normal measurement data for the items which are set to ON using MEASure:ITEM commands ("MEASure:ITEM:FLICkeR?" through "MEASure:ITEM[:NORMal]:PRESet"). | App 2-39       |
| <b>PRINT Group</b>  |   |                |
| :PRINT?   | Queries all the current built-in printer settings.  | App 2-46       |
| :PRINT:ABORt  | Stops printing.   | App 2-46       |
| :PRINT:AUTO?  | Queries all the current auto print mode settings.   | App 2-46       |
| :PRINT:AUTO:INTERVal  | Sets print interval for auto print mode/queries the current setting.  | App 2-46       |
| :PRINT:AUTO:STARt   | Sets start time for auto print mode/queries the current setting.  | App 2-46       |
| :PRINT:AUTO[:STATe]   | Turns auto print mode ON or OFF/queries the current setting.  | App 2-46       |
| :PRINT:AUTO:STOP  | Sets stop time for auto print mode/queries the current setting.   | App 2-46       |
| :PRINT:AUTO:SYNChronize   | Sets print synchronization method for auto print mode/queries the current setting.  | App 2-47       |
| :PRINT:FEED   | Feeds print paper.  | App 2-47       |
| :PRINT:ITEM?  | Queries all the printer settings for measured/computed data.  | App 2-47       |
| :PRINT:ITEM:FLICkeR?  | Queries all the printer output items for flicker measurement.   | App 2-47       |
| :PRINT:ITEM:FLICkeR:CPF?  | Queries all the CPF graph print data output items.  | App 2-47       |
| :PRINT:ITEM:FLICkeR:CPF[:ALL]                                   | Turns printer output of CPF graph ON or OFF for all the elements at once.   | App 2-47       |
| :PRINT:ITEM:FLICkeR:CPF:ELEMEnt<x>                              | Turns printer output of CPF graph ON or OFF for the specified elements/queries the current setting.   | App 2-47       |
| :PRINT:ITEM:FLICkeR:JUDGE?                                      | Queries all the printer output items for flicker meter judgment result table.   | App 2-47       |
| :PRINT:ITEM:FLICkeR:JUDGE[:ALL]                                 | Turns printer output of flicker meter judgment result table ON or OFF for all the elements at once.   | App 2-47       |
| :PRINT:ITEM:FLICkeR:JUDGE:ELEMEnt<x>                            | Turns printer output of flicker meter judgment result table ON or OFF for the specified element/queries the current setting.  | App 2-47       |
| :PRINT:ITEM:FLICkeR:PRESet                                      | Turns printer output ON or OFF for all the flicker measurement functions at once.   | App 2-47       |
| :PRINT:ITEM:HARMonics?  | Queries all the print output items for harmonic analysis data.  | App 2-47       |
| :PRINT:ITEM:HARMonics:<Harmonic analysis function>?             | Queries all the printer output settings for the specified harmonic analysis print function.   | App 2-48       |
| PRINT:ITEM:HARMonics:<Harmonic analysis function>[:ALL]         | Turns printer output for the specified harmonic analysis print function ON or OFF for all the elements at once.   | App 2-48       |
| PRINT:ITEM:HARMonics:<Harmonic analysis function>:ELEMEnt<x>    | Turns printer output for the specified harmonic analysis print function ON or OFF for the specified element/queries the current setting.                            | App 2-48       |
| :PRINT:ITEM:HARMonics:PRESet                                    | Turns printer output ON or OFF for all the harmonic analysis print functions at once.   | App 2-48       |
| :PRINT:ITEM:NORMal?   | Queries all the printer output items for normal measurement data.   | App 2-48       |
| :PRINT:ITEM:NORMal:<Normal measurement function>?               | Queries all the printer output settings for the specified normal measurement function.  | App 2-49       |
| :PRINT:ITEM:NORMal:<Normal measurement function>[:ALL]          | Turns printer output for the specified normal measurement function ON or OFF for all the elements at once.  | App 2-49       |
| :PRINT:ITEM:NORMal:<Normal measurement function>:ELEMEnt<x>     | Turns printer output for the specified normal measurement function ON or OFF for the specified element/queries the current setting.                                 | App 2-49       |
| :PRINT:ITEM:NORMal:<Normal measurement function>:SIGMa          | Turns printer output of specified $\Sigma$ data ON or OFF for the normal measurement function/queries the current setting.  | App 2-49       |

| Command                                  | Function  | Reference Page |
|--|---|----------------|
| :PRINT:ITEM:NORMAL:{TIME FREQUENCY MATH} | Turns printer output ON or OFF for the computed elapsed time of integration, frequency and efficiency/queries the current setting.            | App 2-49       |
| :PRINT:ITEM:NORMAL:PRESet                | Turns printer output ON or OFF for all the normal measurement functions at once.  | App 2-49       |
| :PRINT:PANel                             | Prints panel set-up information.  | App 2-49       |
| :PRINT:VALue                             | Prints measured/computed data for the items which are set to ON using PRINT:ITEM commands ("PRINT:ITEM?" through "PRINT:ITEM:NORMAL:PRESet"). | App 2-49       |
| <b>RECall Group</b>                      |   |                |
| RECall:PANel                             | Recalls set-up information from the specified file of the internal memory.  | App 2-50       |
| <b>SAMPlE Group</b>                      |   |                |
| :SAMPLe?                                 | Queries all the current sampling settings.  | App 2-50       |
| :SAMPLe:HOLD                             | Turns hold mode for output data (display, communication data) ON and ON/queries the current setting.  | App 2-50       |
| :SAMPLe:RATE                             | Sets sample rate/queries the current setting.   | App 2-50       |
| <b>STATus Group</b>                      |   |                |
| :STATus?                                 | Queries all the settings relating to the communications status function.  | App 2-51       |
| :STATus:CONDition?                       | Queries the contents of the condition register.   | App 2-51       |
| :STATus:EESE                             | Sets the extended event enable register/queries the current setting.  | App 2-51       |
| :STATus:EESR?                            | Queries the contents of the extended event register and clears the register.  | App 2-51       |
| :STATus:ERRor?                           | Queries the code and the message (at the beginning of the error queue) of the error which has occurred.                                       | App 2-51       |
| :STATus:FILTer<x>                        | Queries all the settings relating to the specified transit filter/queries the current settings.   | App 2-52       |
| :STATus:QMESsage                         | Selects whether or not to add the message contents to a response to "STATus:ERRor?" /queries the current setting.                             | App 2-52       |
| :STATus:SPOLl?(Serial Poll)              | Executes serial poll.   | App 2-52       |
| <b>STORe Group</b>                       |   |                |
| :STORe:PANel                             | Stores set-up information in the internal memory.   | App 2-52       |
| <b>SYSTem Group</b>                      |   |                |
| :SYSTem?                                 | Queries all the system (internal clock) settings.   | App 2-53       |
| :SYSTem:DATE                             | Sets the date/queries the current setting.  | App 2-53       |
| :SYSTem:TIME                             | Sets the time/queries the current setting.  | App 2-53       |
| <b>Common Command Group</b>              |   |                |
| *CLS                                     | Clears the standard event register, extended event register and error queue.  | App 2-54       |
| *ESE                                     | Sets the value for the standard event enable register/queries the current setting.  | App 2-54       |
| *ESR?                                    | Queries the value of the standard event register and clears it at the same time.  | App 2-54       |
| *IDN?                                    | Queries the instrument model.   | App 2-54       |
| *OPC                                     | (Not supported by this instrument.)   | App 2-54       |
| *OPC?                                    | ("1" will always be returned since overlap commands are not supported by this instrument.)  | App 2-55       |
| *OPT?                                    | Queries installed options.  | App 2-55       |
| *PSC                                     | Selects whether or not to clear the registers when power is turned ON/queries the current setting.  | App 2-55       |
| *RST                                     | Resets the current settings.  | App 2-55       |
| *SRE                                     | Sets the value of the service request enable register/queries the current setting.  | App 2-55       |
| *STB?                                    | Queries the value of the status byte register.  | App 2-55       |
| *TRG                                     | Carries out the same function as when the TRIG key (SHIFT + HOLD) is pressed.   | App 2-55       |
| *TST?                                    | Executes a self-test and queries the test result.   | App 2-55       |
| *WAI                                     | (Not supported by this instrument.)   | App 2-55       |



### 2.3.2 AOUPut Group

The commands in the AOUPut group are used to make settings relating to and inquire about D/A output. This allows you to make the same settings and inquiries which can be made using the MISC key ("dA-out" menu and "itG-t" menu) on the front panel. These commands are available if the instrument is equipped with the D/A output function (/DA model).

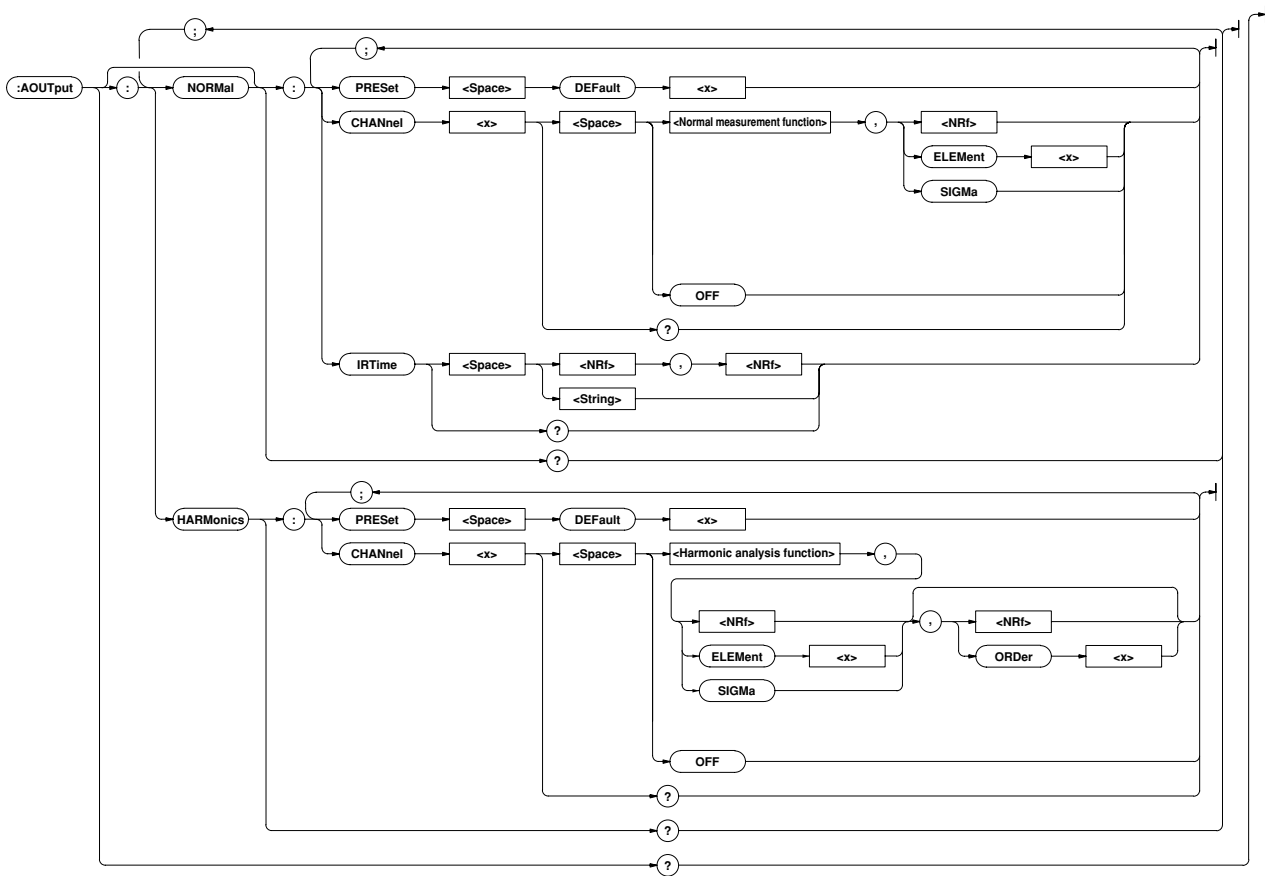

#### AOUPut?

**Function** Queries all the current D/A output settings.

**Syntax** AOUPut?

**Example** AOUPUT? →:AOUPUT:NORMAL:CHANNEL1 V,1;CHANNEL2 V,2;CHANNEL3 V,3;CHANNEL4 V,SIGMA;CHANNEL5 A,1;CHANNEL6 A,2;CHANNEL7 A,3;CHANNEL8 A,SIGMA;CHANNEL9 W,1;CHANNEL10 W,2;CHANNEL11 W,3;CHANNEL12 W,SIGMA;CHANNEL13 W,1;CHANNEL14 W,1;IRTIME 1,0;:AOUPUT:HARMONICS:CHANNEL1 A,1,1;CHANNEL2 A,1,2;CHANNEL3 A,1,3;CHANNEL4 A,1,4;CHANNEL5 A,1,5;CHANNEL6 A,1,6;CHANNEL7 A,1,7;CHANNEL8 A,1,8;CHANNEL9 A,1,9;CHANNEL10 A,1,10;CHANNEL11 A,1,11;CHANNEL12 A,1,12;CHANNEL13 A,1,13;CHANNEL14 SYNCHRONIZE

#### AOUPut:HARMONICS?

**Function** Queries all the current D/A output item settings for harmonic analysis mode.

**Syntax** AOUPut:HARMONICS?

**Example** AOUPUT:HARMONICS? →:AOUPUT:HARMONICS:CHANNEL1 A,1,1;CHANNEL2 A,1,2;CHANNEL3 A,1,3;CHANNEL4 A,1,4;CHANNEL5 A,1,5;CHANNEL6 A,1,6;CHANNEL7 A,1,7;CHANNEL8 A,1,8;CHANNEL9 A,1,9;CHANNEL10 A,1,10;CHANNEL11 A,1,11;CHANNEL12 A,1,12;CHANNEL13 A,1,13;CHANNEL14 SYNCHRONIZE

**AOUTput:HARMonics:CHANnel<x>**

**Function** Sets D/A output items for the specified for harmonic analysis mode /queries the current setting.

**Syntax** AOUTput:HARMonics:CHANnel<x> {<Harmonic analysis function>, (<NRf>|ELEMeNt<1-3>|SIGMa), (<NRf>|ORDER<1-50>)|OFF}  
 AOUTput:HARMonics:CHANnel<x>?  
 <x>1 to 14(output channel)  
 <Harmonic analysis function>= {V|A|W|VA|VAR|PF|DEG|VTHD|ATHD|VCON|ACON|WCON|VDEG|ADEG|SYNChronize}

**Example** AOUTPUT:HARMONICS:CHANNEL1 A,1,1  
 AOUTPUT:HARMONICS:CHANNEL2 ATHD,1  
 AOUTPUT:HARMONICS:CHANNEL3 OFF  
 AOUTPUT:HARMONICS:CHANNEL1? →:AOUTPUT:HARMONICS:CHANNEL1 A,1,1  
 AOUTPUT:HARMONICS:CHANNEL2? →:AOUTPUT:HARMONICS:CHANNEL2 ATHD,1  
 AOUTPUT:HARMONICS:CHANNEL3? →:AOUTPUT:HARMONICS:CHANNEL3 OFF

**Description** The element and order are set as follows according to the selected harmonic analysis function.

{V|A|W}: If no order is set, total rms value from 1st to 50th will be selected.

{VA|VAR|PF|DEG|VTHD|ATHD}: The order can be omitted, since it is meaningless.

{SYNChronize}: The element and order can be omitted, since they are meaningless.

{V|A|W|VA|VAR|PF}: SIGMa can be set for elements. In this case, the order can be omitted, since it is meaningless. However, if the query command is executed, "1" will be returned as the order for V, A and W (to distinguish from the total rms value of 1st to 50th).

**AOUTput:HARMonics:PRESet**

**Function** Sets D/A output items for harmonic analysis mode to the specified default setting at once.

**Syntax** AOUTput:HARMonics:PRESet {DEFault<1-2>}

**Example** AOUTPUT:HARMONICS:PRESET DEFAULT1

**Description** For a description of global setting for {DEFault<1-2>}, refer to Section 12.3, "D/A Output".

**AOUTput:NORMal?**

**Function** Queries all the current D/A output item settings for normal measurement mode.

**Syntax** AOUTput:NORMal?

**Example** AOUTPUT:NORMAL? →:AOUTPUT:NORMAL:CHANNEL1 V,1;CHANNEL2 V,2;CHANNEL3 V,3;CHANNEL4 V,SIGMA;CHANNEL5 A,1;CHANNEL6 A,2;CHANNEL7 A,3;CHANNEL8 A,SIGMA;CHANNEL9 W,1;CHANNEL10 W,2;CHANNEL11 W,3;CHANNEL12 W,SIGMA;CHANNEL13 W,1;CHANNEL14 W,1;IRTIME 1,0

**AOUTput[:NORMal]:CHANnel<x>**

**Function** Sets D/A output items for the specified channel for normal measurement mode/queries the current setting.

**Syntax** AOUTput[:NORMal]:CHANnel<x> {<Normal measurement function>, (<NRf>|ELEMeNt<1-3>|SIGMa)|OFF}  
 AOUTput[:NORMal]:CHANnel<x>?  
 <x>1 to 14(output channel)  
 <Normal measurement function>= {V|A|W|VA|VAR|PF|DEG|VPK|APK|WH|WHP|WHM|AH|AHP|AHM|FREQuency|EFFiciency|TIME}

**Example** AOUTPUT:NORMAL:CHANNEL1 V,1  
 AOUTPUT:NORMAL:CHANNEL2 FREQUENCY  
 AOUTPUT:NORMAL:CHANNEL3 OFF  
 AOUTPUT:NORMAL:CHANNEL1? →:AOUTPUT:NORMAL:CHANNEL1 V,1  
 AOUTPUT:NORMAL:CHANNEL2? →:AOUTPUT:NORMAL:CHANNEL2 FREQUENCY  
 AOUTPUT:NORMAL:CHANNEL3? →:AOUTPUT:NORMAL:CHANNEL3 OFF

**Description** The element is set as follows according to the selected normal measurement function.

{FREQuency|EFFiciency|TIME}: The element can be omitted, since it is meaningless.

{VPK|APK}: SIGMa cannot be set for elements.

**AOUTput[:NORMal]:IRTime**

**Function** Sets the rated integration time for D/A output of integrated values/queries the current setting.

**Syntax** AOUTput[:NORMal]:IRTime {<NRf>,<NRf>|<Character string>}  
 AOUTput[:NORMal]:IRTime?  
 {<NRf>,<NRf>}= 0,1 to 999,59  
 {<Character string>}="HHH:MM" HHH:Hour  
 MM:Minute

**Example** AOUTPUT:NORMAL:IRTIME 1,0  
 AOUTPUT:NORMAL:IRTIME "1:00"  
 AOUTPUT:NORMAL:IRTIME? →:AOUTPUT:NORMAL:IRTIME 1,0

**AOUTput[:NORMal]:PRESet**

**Function** Sets D/A output items for normal measurement mode to the specified default setting at once.

**Syntax** AOUTput[:NORMal]:PRESet {DEFault<1-2>}

**Example** AOUTPUT:NORMAL:PRESET DEFAULT1

**Description** For a description of global setting for {DEFault<1-2>}, refer to Section 12.3, "D/A Output".

### 2.3.3 COMMunicate Group

The commands in the COMMunicate group are used to make settings relating to and inquire about communications. There is no front panel key for this function.

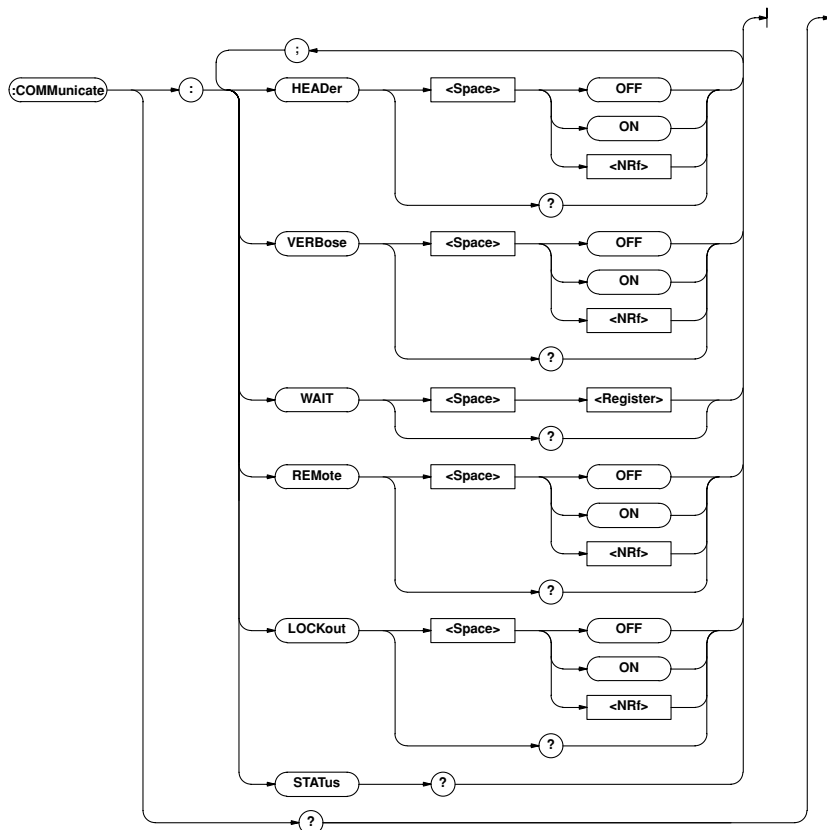

#### COMMunicate?

**Function** Queries all the communications settings.

**Syntax** COMMunicate?

**Example** COMMUNICATE?

→:COMMUNICATE:HEADER 1;VERBOSE 1

#### COMMunicate:HEADer

**Function** Determines whether a header is added (example: CONFIGURE:VOLTAGE:RANGE:ELEMENT1 150.0E+00) or not (example:150.0E+00) when sending a response to a query/queries the current setting.

**Syntax** COMMunicate:HEADer {<Boolean>}  
COMMunicate:HEADer?

**Example** COMMUNICATE:HEADER ON

COMMUNICATE:HEADER?→:COMMUNICATE:HEADER 1

#### COMMunicate:LOCKout

**Function** Turns the local lock out function ON or OFF.

**Syntax** COMMunicate:LOCKout {<Boolean>}  
COMMunicate:LOCKout?

**Example** COMMUNICATE:LOCKOUT ON

COMMUNICATE:LOCKOUT?→:COMMUNICATE:LOCKOUT 1

**Description** This command is available only for the RS-232-C interface.

#### COMMunicate:REMote

**Function** Selects remote mode or local mode. Remote mode is selected if this command is set to ON.

**Syntax** COMMunicate:REMote {<Boolean>}  
COMMunicate:REMote?

**Example** COMMUNICATE:REMOTE ON

COMMUNICATE:REMOTE?→:COMMUNICATE:REMOTE 1

**Description** This command is available only for the RS-232-C interface.

**COMMunicate:STATus?**

**Function** Queries the current network status.

**Syntax** COMMunicate:STATus?

**Example** COMMUNICATE:STATUS?→:COMMUNICATE:STATUS 0

**Description** Meaning of each bit of the status is given below.

| Bit       | GP-IB                                       | RS-232-C                  |
|-----------|---|---------------------------|
| 0         | Transmission error for non-recoverable 7210 | Parity error              |
| 1         | Always set to 0.                            | Framing error             |
| 2         | Always set to 0.                            | Break character detection |
| 3 or more | Always set to 0.                            | Always set to 0.          |

A status bit is set when its corresponding cause occurs, and cleared when it is read.

**COMMunicate:VERBoSe**

**Function** Determines whether a response to a query is to be returned full in form (for example:CONFIGURE : VOLTAGE:RANGE:ELEMENT1 150.0E+00) or in abbreviated form (for example:VOLT:RANG:ELEM 150.0E+00)/queries the current setting.

**Syntax** COMMunicate:VERBoSe {<Boolean>}

COMMunicate:VERBoSe?

**Example** COMMUNICATE:VERBOSE ON

COMMUNICATE:VERBOSE?→:COMMUNICATE:VERBOSE 1

**COMMunicate:WAIT**

**Function** Waits until one of the specified extended event occurs.

**Syntax** COMMunicate:WAIT <Register>

<Register>= 0 to 65535(For a description of the extended event register, refer to page App 2-59.)

**Example** COMMUNICATE:WAIT 65535

**Description** For a description of synchronization using COMMunicate:WAIT, refer to page App 2-8.

**COMMunicate:WAIT?**

**Function** Generates a response when one of the specified extended events occurs.

**Syntax** COMMunicate:WAIT? <Register>

<Register>= 0 to 65535(For a description of the extended event register, refer to page App 2-59.)

**Example** COMMUNICATE:WAIT? 65535→1

### 2.3.4 CONFigure Group

The commands in the CONFigure group are used to make settings relating to and to inquire about measurement conditions. This allows you to make the same settings and inquiries which you can make using the WIRING key, VOLTAGE (CURRENT) RANGE related keys, and LINE FILTER, SCALING, AVG, PEAK HOLD (SHIFT + RATE), CF3/CF6 (SHIFT +  $\wedge/\vee$ ), NULL (SHIFT + TRIG) and MISC ("F-FiLt", "HOLd-F" and "dEG" menus) keys on the front panel.

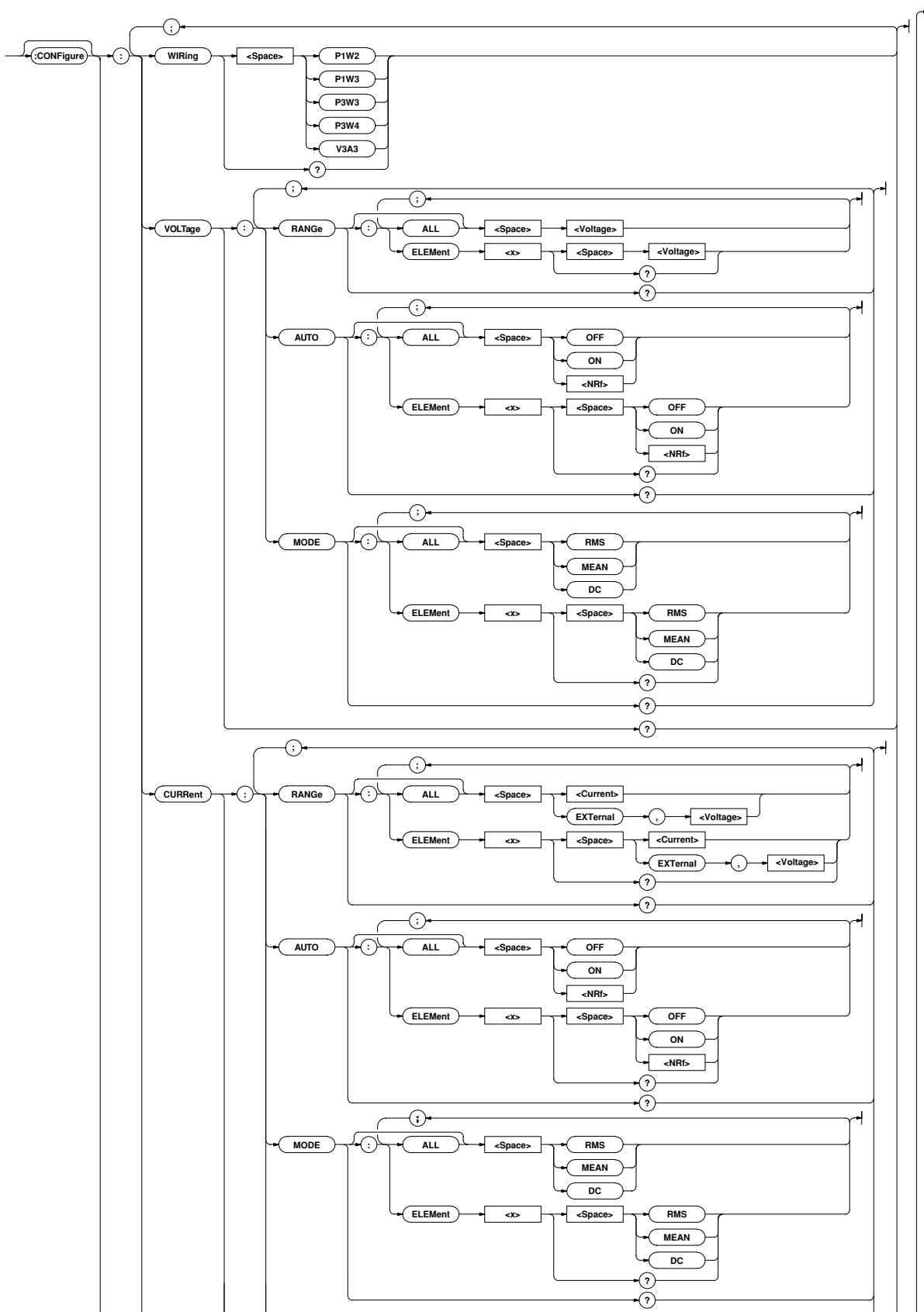

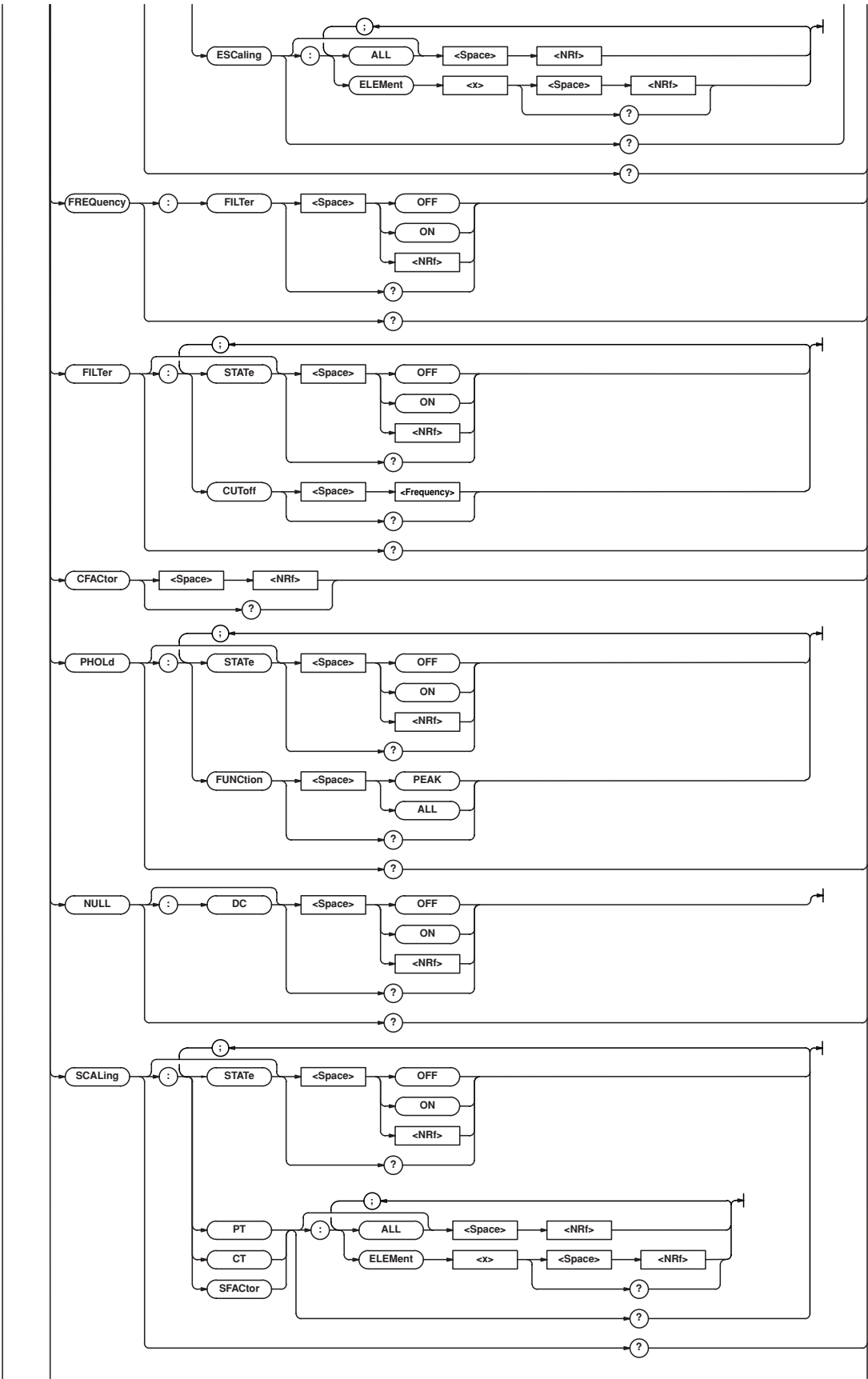

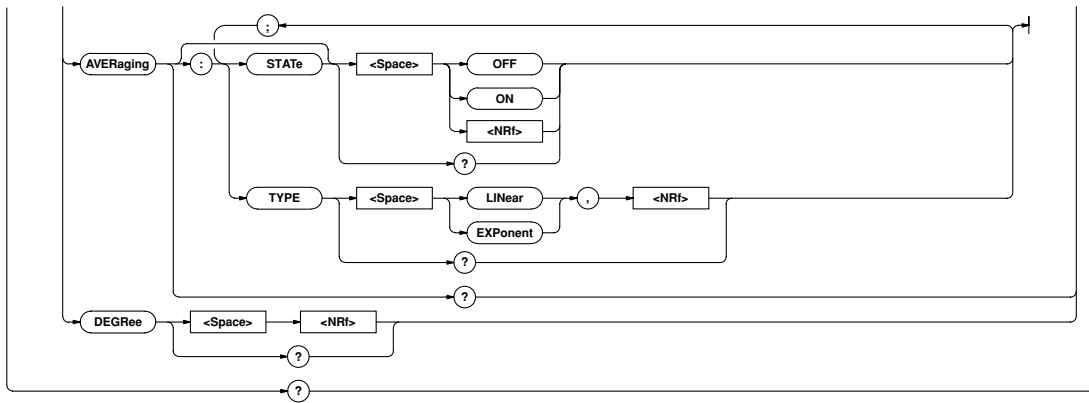

### CONFigure?

**Function** Queries all the measurement condition settings.

**Syntax** CONFigure?

**Example** CONFIGURE? →:CONFIGURE:WIRING P1W2;  
 VOLTAGE:RANGE:ELEMENT1 600.0E+00;ELEMENT2  
 600.0E+00;ELEMENT3 600.0E+00;:CONFIGURE:  
 VOLTAGE:AUTO:ELEMENT1 0;ELEMENT2 0;ELEMENT3  
 0;:CONFIGURE: VOLTAGE:MODE:ELEMENT1 RMS;ELEMENT2  
 RMS; ELEMENT3 RMS;:CONFIGURE:CURRENT:RANGE:ELEMENT1  
 30.0E+00;ELEMENT2 30.0E+00;ELEMENT3 30.0E+00;  
 :CONFIGURE:CURRENT:AUTO:ELEMENT1 0;ELEMENT2  
 0;ELEMENT3 0;:CONFIGURE:CURRENT:MODE:ELEMENT1  
 RMS;ELEMENT2 RMS;ELEMENT3 RMS;:CONFIGURE:CURRENT:  
 ESCALING:ELEMENT1 50.000E+00;ELEMENT2 50.000E+00;  
 ELEMENT3 50.000E+00;:CONFIGURE:FREQUENCY:SOURCE  
 V,1;FILTER 0;:CONFIGURE:FILTER:STATE 0;CUTOFF  
 0.500E+03;:CONFIGURE:CAFACTOR 3;PHOLD:STATE  
 0;FUNCTION PEAK;:CONFIGURE:NULL:DC 0;:CONFIGURE:  
 SCALING:STATE 0;PT:ELEMENT1 1.0000E+00;ELEMENT2  
 1.0000E+00; ELEMENT3 1.0000E+00;:CONFIGURE: SCALING:  
 CT:ELEMENT1 1.0000E+00;ELEMENT2 1.0000E+00;ELEMENT3  
 1.0000E+00;:CONFIGURE: SCALING:SFACTOR:ELEMENT1  
 1.0000E+00;ELEMENT2 1.0000E+00;ELEMENT3 1.0000E+00;  
 :CONFIGURE: AVERAGING:STATE 0;TYPE EXPONENT,8;  
 CONFIGURE:DEGREE 180

### [:CONFigure]:AVERaging?

**Function** Queries all the averaging function settings.

**Syntax** [:CONFigure]:AVERaging?

**Example** CONFIGURE:AVERAGING? →:CONFIGURE:AVERAGING:STATE  
 0;TYPE EXPONENT,8

### [:CONFigure]:AVERaging[:STATe]

**Function** Turns the averaging function ON or OFF/queries the current setting.

**Syntax** [:CONFigure]:AVERaging[:STATe] {<Boolean>}  
 [:CONFigure]:AVERaging:STATe?

**Example** CONFIGURE:AVERAGING:STATE OFF  
 CONFIGURE:AVERAGING:STATE? →:CONFIGURE:AVERAGING  
 :STATE 0

### [:CONFigure]:AVERaging:TYPE

**Function** Sets the averaging type/queries the current setting.

**Syntax** [CONFigure]:AVERaging:TYPE  
 {(LINear|EXPonent),<NRf>}  
 [CONFigure]:AVERaging:TYPE?  
 {<NRf>}=8,16,32,64,128,256 (averaging  
 factor)

**Example** CONFIGURE:AVERAGING:TYPE EXPONENT,8  
 CONFIGURE:AVERAGING:TYPE?  
 →:CONFIGURE:AVERAGING:TYPE EXPONENT,8

### [:CONFigure]:CFACtor

**Function** Sets the crest factor/queries the current setting.

**Syntax** [CONFigure]:CFACtor {<NRf>}  
 [CONFigure]:CFACtor?  
 {<NRf>}=3, 6

**Example** CONFIGURE:CFACtor 3  
 CONFIGURE:CFACtor? →:CONFIGURE:CFACtor 3

### [:CONFigure]:CURRent?

**Function** Queries all the current measurement settings.

**Syntax** [CONFigure]:CURRent?

**Example** CONFIGURE:CURRENT? →:CONFIGURE:CURRENT:RANGE:  
 ELEMENT1 30.0E+00;ELEMENT2 30.0E+00;ELEMENT3  
 30.0E+00;:CONFIGURE:CURRENT:AUTO:ELEMENT1  
 0;ELEMENT2 0;ELEMENT3 0;:CONFIGURE:CURRENT:MODE:  
 ELEMENT1 RMS;ELEMENT2 RMS;ELEMENT3 RMS;:  
 CONFIGURE:CURRENT:ESCALING:ELEMENT1  
 50.000E+00;ELEMENT2 50.000E+00;ELEMENT3 50.000E+00

### [:CONFigure]:CURRent:AUTO?

**Function** Queries ON/OFF state of current auto range for each element.

**Syntax** [CONFigure]:CURRent:AUTO?

**Example** CONFIGURE:CURRENT:AUTO? →:CONFIGURE:CURRENT:AUTO:  
 ELEMENT1 0;ELEMENT2 0;ELEMENT3 0

### [:CONFigure]:CURRent:AUTO[:ALL]

**Function** Sets current auto range ON or OFF for all the elements at once.

**Syntax** [CONFigure]:CURRent:AUTO[:ALL] {<Boolean>}

**Example** CONFIGURE:CURRENT:AUTO:ALL OFF

**[[:CONFigure]:CURRENT:AUTO:ELEMENT<x>**

**Function** Sets current auto range ON or OFF for the specified element/queries the current setting.

**Syntax** [CONFigure]:CURRENT:AUTO:ELEMENT<x>  
{<Boolean>}  
[CONFigure]:CURRENT:AUTO:ELEMENT<x>?  
<x>=1,3(3-phase 3-wire model)  
1 to 3(3-phase 4-wire model)

**Example** CONFIGURE:CURRENT:AUTO:ELEMENT1 OFF  
CONFIGURE:CURRENT:AUTO:ELEMENT1?  
→:CONFIGURE:CURRENT:AUTO:ELEMENT1 0

**[[:CONFigure]:CURRENT:ESCALING?**

**Function** Queries all the external shunt current values.

**Syntax** [CONFigure]:CURRENT:ESCALING?

**Example** CONFIGURE:CURRENT:ESCALING?  
→:CONFIGURE:CURRENT:ESCALING:ELEMENT1  
50.000E+00;ELEMENT2 50.000E+00;ELEMENT3  
50.000E+00

**[[:CONFigure]:CURRENT:ESCALING[:ALL]**

**Function** Sets the external shunt current value for all the elements at once.

**Syntax** [CONFigure]:CURRENT:ESCALING[:ALL]  
{<Nrf>}  
{<Nrf>}=0.0200 to 1000.0

**Example** CONFIGURE:CURRENT:ESCALING:ALL 50.000

**Description** Scaling constants are rounded as follows.

Below 1.0000 Rounded to four decimal places.  
1.0000 to 1000.0 Rounded to five significant digits.

**[[:CONFigure]:CURRENT:ESCALING:ELEMENT<x>**

**Function** Sets the external shunt current value for the specified element/queries the current setting.

**Syntax** [CONFigure]:CURRENT:ESCALING:ELEMENT<x> {<Nrf>}  
[CONFigure]:CURRENT:ESCALING:ELEMENT<x>?  
<x>= 1,3(3-phase 3-wire model)  
1 to 3(3-phase 4-wire model)  
{<Nrf>}=0.0200 to 1000.0

**Example** CONFIGURE:CURRENT:ESCALING:ELEMENT1 50.000  
CONFIGURE:CURRENT:ESCALING:ELEMENT1?  
→:CONFIGURE:CURRENT:ESCALING:ELEMENT1  
50.000E+00

**Description** Scaling constants are rounded in the same way as for [CONFigure]:CURRENT:ESCALING[:ALL].

**[[:CONFigure]:CURRENT:MODE?**

**Function** Queries current measurement mode for each element.

**Syntax** [CONFigure]:CURRENT:MODE?

**Example** CONFIGURE:CURRENT:MODE?→:CONFIGURE:CURRENT  
:MODE:ELEMENT1 RMS;ELEMENT2 RMS;ELEMENT3 RMS

**[[:CONFigure]:CURRENT:MODE[:ALL]**

**Function** Sets current measurement mode for all the elements at once.

**Syntax** [CONFigure]:CURRENT:MODE[:ALL] {RMS|MEAN|DC}

**Example** CONFIGURE:CURRENT:MODE:ALL RMS

**[[:CONFigure]:CURRENT:MODE:ELEMENT<x>**

**Function** Sets current measurement mode for the specified element/queries the current setting.

**Syntax** [CONFigure]:CURRENT:MODE:ELEMENT<x>  
{RMS|MEAN|DC}  
[CONFigure]:CURRENT:MODE:ELEMENT<x>?  
<x>=1,3(3-phase 3-wire model)  
1 to 3(3-phase 4-wire model)

**Example** CONFIGURE:CURRENT:MODE:ELEMENT1 RMS  
CONFIGURE:CURRENT:MODE:ELEMENT1?  
→:CONFIGURE:CURRENT:MODE:ELEMENT1 RMS

**[[:CONFigure]:CURRENT:RANGE?**

**Function** Queries current range (external shunt range) for each element.

**Syntax** [CONFigure]:CURRENT:RANGE?

**Example** CONFIGURE:CURRENT:RANGE?→:CONFIGURE:  
CURRENT:RANGE:ELEMENT1 30.0E+00;ELEMENT2  
30.0E+00;ELEMENT3 30.0E+00

**[[:CONFigure]:CURRENT:RANGE[:ALL]**

**Function** Sets current range (external shunt range) for all the elements at once.

**Syntax** [CONFigure]:CURRENT:RANGE[:ALL]  
{<Current>| (EXTERNAL,<Voltage>)}  
<Current>=1A to 30A(1,2,5,10,20,30A)  
<Voltage>=50mV to 200mV(50,100,200mV)

**Example** Setting current range

CONFIGURE:CURRENT:RANGE:ALL 20A  
Setting external sensor input range  
CONFIGURE:CURRENT:RANGE:ALL EXTERNAL,250MV

**[[:CONFigure]:CURRENT:RANGE:ELEMENT<x>**

**Function** Sets current range (external shunt range) for the specified element/queries the current setting.

**Syntax** [CONFigure]:CURRENT:RANGE:ELEMENT<x>  
{<Current>| (EXTERNAL,<Voltage>)}  
[CONFigure]:CURRENT:RANGE:ELEMENT<x>?  
<x>=1,3(3-phase 3-wire model)  
1 to 3(3-phase 4-wire model)

<Current>= 1A to 30A (1,2,5,10,20,30A)  
<Voltage>= 50mV to 200mV(50,100,200mV)

**Example** Setting/inquiring about current range

CONFIGURE:CURRENT:RANGE:ELEMENT1 30A  
CONFIGURE:CURRENT:RANGE:ELEMENT1?  
→:CONFIGURE:CURRENT:RANGE:ELEMENT1  
30.0E+00  
Setting/inquiring about external sensor input range  
CONFIGURE:CURRENT:RANGE:ELEMENT1  
EXTERNAL,50MV  
CONFIGURE:CURRENT:RANGE:ELEMENT1?  
→:CONFIGURE:CURRENT:RANGE:ELEMENT1  
EXTERNAL,50.0E-03



### **[[:CONFigure]:DEGRee**

**Function** Sets phase angle display method/queries the current setting.

**Syntax** [CONFigure]:DEGRee {<NRf>}  
[CONFigure]:DEGRee?  
{<NRf>}=180,360

**Example** CONFIGURE:DEGREE 180  
CONFIGURE:DEGREE?→:CONFIGURE:DEGREE 180

### **[[:CONFigure]:FILTer?**

**Function** Queries the current line filter setting.

**Syntax** [CONFigure]:FILTer?

**Example** CONFIGURE:FILTER?→:CONFIGURE:FILTER:STATE  
0;CUTOFF 0.500E+03

### **[[:CONFigure]:FILTer:CUToff**

**Function** Sets line filter cut-off frequency/queries the current setting.

**Syntax** [CONFigure]:FILTer:CUToff {<Frequency>}  
[CONFigure]:FILTer:CUToff?  
<Frequency>= 500HZ,5.5KHZ

**Example** CONFIGURE:FILTER:CUTOFF 0.5KHZ  
CONFIGURE:FILTER:CUTOFF?→:CONFIGURE:FILTER:  
CUTOFF 0.500E+03

### **[[:CONFigure]:FILTer[:STATE]**

**Function** Turns the line filter ON or OFF/queries the current setting.

**Syntax** [CONFigure]:FILTer[:STATE] {<Boolean>}  
[CONFigure]:FILTer:STATE?

**Example** CONFIGURE:FILTER:STATE OFF  
CONFIGURE:FILTER:STATE?→:CONFIGURE:FILTER:  
STATE 0

### **[[:CONFigure]:FREQuency?**

**Function** Queries the current frequency setting.

**Syntax** [CONFigure]:FREQuency?

**Example** CONFIGURE:FREQUENCY?→:CONFIGURE:FREQUENCY  
:FILTER 0

### **[[:CONFigure]:FREQuency:FILTer**

**Function** Turns the frequency filter ON or OFF/queries the current setting.

**Syntax** [CONFigure]:FREQuency:FILTer {<Boolean>}  
[CONFigure]:FREQuency:FILTer?

**Example** CONFIGURE:FREQUENCY:FILTER OFF  
CONFIGURE:FREQUENCY:FILTER?→:CONFIGURE:  
FREQUENCY:FILTER 0

### **[[:CONFigure]:NULL?**

**Function** Queries all the NULL function settings.

**Syntax** [CONFigure]:NULL?

**Example** CONFIGURE:NULL?→:CONFIGURE:NULL:DC0

### **[[:CONFigure]:NULL[:DC]**

**Function** Turns the NULL function ON or OFF/queries the current setting.

**Syntax** [CONFigure]:NULL[:DC]  
[CONFigure]:NULL:DC?

**Example** CONFIGURE:NULL:DC OFF  
CONFIGURE:NULL:DC?→:CONFIGURE:NULL:DC 0

### **[[:CONFigure]:PHOLd?**

**Function** Queries all the peak hold function settings.

**Syntax** [CONFigure]:PHOLd?

**Example** CONFIGURE:PHOLD?→:CONFIGURE:PHOLD:STATE  
0;FUNCTION PEAK

### **[[:CONFigure]:PHOLd:FUNCTion**

**Function** Sets the peak hold function/queries the current setting.

**Syntax** [CONFigure]:PHOLd:FUNCTion {PEAK|ALL}  
[CONFigure]:PHOLd:FUNCTion?

**Example** CONFIGURE:PHOLD:FUNCTION PEAK  
CONFIGURE:PHOLD:FUNCTION→:CONFIGURE:  
PHOLD:FUNCTION PEAK

**Description**

Description of each function is given below.

PEAK : Peak value (Vpk, Apk only)

ALL : V, A, W, VA, var, Vpk, Apk

### **[[:CONFigure]:PHOLd[:STATE]**

**Function** Turns the peak hold function ON or OFF/queries the current setting.

**Syntax** [CONFigure]:PHOLd[:STATE] {<Boo|ean>}  
[CONFigure]:PHOLd:STATE?

**Example** CONFIGURE:PHOLD:STATE OFF  
CONFIGURE:PHOLD:STATE?→:CONFIGURE:PHOLD:  
STATE 0

### **[[:CONFigure]:SCALing?**

**Function** Queries all the current scaling function settings.

**Syntax** [CONFigure]:SCALing?

**Example** CONFIGURE:SCALING?→:CONFIGURE:SCALING:STATE  
0;PT:ELEMENT1 1.0000E+00;ELEMENT2  
1.0000E+00;ELEMENT31.0000E+00;:CONFIGURE:SCALING:CT:  
ELEMENT1 1.0000E+00;ELEMENT2 1.0000E  
+00;ELEMENT31.0000E+00;:CONFIGURE:SCALING:  
SFACtor:ELEMENT1 1.0000E+00;ELEMENT2  
1.0000E+00;ELEMENT3 1.0000E+00

### **[[:CONFigure]:SCALing:{PT|CT|SFACtor}?**

**Function** Queries the current scaling constant (voltage, current, power) for each element.

**Syntax** [CONFigure]:SCALing:{PT|CT|SFACtor}?

**Example** CONFIGURE:SCALING:PT?→:CONFIGURE:SCALING:  
PT:ELEMENT1 1.0000E+00;ELEMENT2  
1.0000E+00;ELEMENT3 1.0000E+00

### **[[:CONFigure]:SCALing:{PT|CT|SFACtor}[:ALL]**

**Function** Sets scaling constant (voltage, current, power) for all the elements at once.

**Syntax** [CONFigure]:SCALing:{PT|CT|SFACtor}[:ALL] {<NRf>}  
{<NRf>}=0.0001 to 10000

**Example** CONFIGURE:SCALING:PT:ALL 1.0000

**Description** Scaling constants are rounded as follows.

Below 1.0000 Rounded to four decimal places.

1.0000 to 10000 Rounded to five significant digits.

**[[:CONFigure]:SCALing:{PT|CT|SFActor}:ELEMEnt<x>**

**Function** Sets scaling constant (voltage, current, power) for the specified element.

**Syntax** [CONFigure]:SCALing:{PT|CT|SFActor}:ELEMEnt<x> {<Nrf>}  
[CONFigure]:SCALing:{PT|CT|SFActor}:ELEMEnt<x>?  
<x>=1,3(3-phase 3-wire model)  
1 to 3(3-phase 4-wire model)  
{<Nrf>}=0.0001 to 10000

**Example** CONFIGURE:SCALING:PT:ELEMENT1 1.0000  
CONFIGURE:SCALING:PT:ELEMENT1?->:CONFIGURE:SCALING:PT:ELEMENT1 1.0000E+00

**Description** Scaling constants are rounded in the same way as for [CONFigure]:SCALing:{PT|CT|SFActor}[:ALL].

**[[:CONFigure]:SCALing[:STATE]**

**Function** Turns the scaling function ON or OFF/queries the current setting.

**Syntax** [CONFigure]:SCALing[:STATE] {<Boolean>}  
[CONFigure]:SCALing:STATE?

**Example** CONFIGURE:SCALING:STATE OFF  
CONFIGURE:SCALING:STATE?->:CONFIGURE:SCALING:STATE 0

**[[:CONFigure]:VOLTage?**

**Function** Queries all the voltage measurement settings.

**Syntax** [CONFigure]:VOLTage?

**Example** CONFIGURE:VOLTAGE?->:CONFIGURE:VOLTAGE:RANGE:ELEMENT1 600.0E+00;ELEMENT2 600.0E+00;ELEMENT3 600.0E+00;:CONFIGURE:VOLTAGE:AUTO:ELEMENT1 0;ELEMENT2 0;ELEMENT3 0;:CONFIGURE:VOLTAGE:MODE:ELEMENT1 RMS;ELEMENT2 RMS;ELEMENT3 RMS

**[[:CONFigure]:VOLTage:AUTO?**

**Function** Queries ON/OFF state of voltage auto range for each element.

**Syntax** [CONFigure]:VOLTage:AUTO?

**Example** CONFIGURE:VOLTAGE:AUTO?->:CONFIGURE:VOLTAGE:AUTO:ELEMENT1 0;ELEMENT2 0;ELEMENT3 0

**[[:CONFigure]:VOLTage:AUTO[:ALL]**

**Function** Sets voltage auto range ON or OFF for all the elements at once.

**Syntax** [CONFigure]:VOLTage:AUTO[:ALL] {<Boolean>}  
**Example** CONFIGURE:VOLTAGE:AUTO:ALL OFF

**[[:CONFigure]:VOLTage:AUTO:ELEMEnt<x>**

**Function** Sets voltage auto range ON or OFF for the specified element/queries the current setting.

**Syntax** [CONFigure]:VOLTage:AUTO:ELEMEnt<x> {<Boolean>}  
[CONFigure]:VOLTage:AUTO:ELEMEnt<x>?  
<x>=1,3(3-phase 3-wire model)  
1 to 3(3-phase 4-wire model)

**Example** CONFIGURE:VOLTAGE:AUTO:ELEMENT1 OFF  
CONFIGURE:VOLTAGE:AUTO:ELEMENT1?->:CONFIGURE:VOLTAGE:AUTO:ELEMENT1 0

**[[:CONFigure]:VOLTage:MODE?**

**Function** Queries voltage measurement mode for each element.

**Syntax** [CONFigure]:VOLTage:MODE?

**Example** CONFIGURE:VOLTAGE:MODE?->:CONFIGURE:VOLTAGE:MODE:ELEMENT1 RMS;ELEMENT2 RMS;ELEMENT3 RMS

**[[:CONFigure]:VOLTage:MODE[:ALL]**

**Function** Sets voltage measurement mode for all the elements at once.

**Syntax** [CONFigure]:VOLTage:MODE[:ALL] {RMS|MEAN|DC}

**Example** CONFIGURE:VOLTAGE:MODE:ALL RMS

**[[:CONFigure]:VOLTage:MODE:ELEMEnt<x>**

**Function** Sets voltage measurement mode for the specified element/queries the current setting.

**Syntax** [CONFigure]:VOLTage:MODE:ELEMEnt<x> {RMS|MEAN|DC}  
[CONFigure]:VOLTage:MODE:ELEMEnt<x>?  
<x>=1,3(3-phase 3-wire model)  
1 to 3(3-phase 4-wire model)

**Example** CONFIGURE:VOLTAGE:MODE:ELEMENT1 RMS  
CONFIGURE:VOLTAGE:MODE:ELEMENT1?->:CONFIGURE:VOLTAGE:MODE:ELEMENT1 RMS

**[[:CONFigure]:VOLTage:RANGE?**

**Function** Queries voltage range for each element.

**Syntax** [CONFigure]:VOLTage:RANGE?

**Example** CONFIGURE:VOLTAGE:RANGE?->:CONFIGURE:VOLTAGE:RANGE:ELEMENT1 600.0E+00;ELEMENT2 600.0E+00;ELEMENT3 600.0E+00

**[[:CONFigure]:VOLTage:RANGE[:ALL]**

**Function** Sets voltage range for all the elements at once.

**Syntax** [CONFigure]:VOLTage:RANGE[:ALL] {<Voltage>}  
<Voltage>=10V to 600V(10,15,30,60,100,150,300,600V)

**Example** CONFIGURE:VOLTAGE:RANGE:ALL 1000V

**[[:CONFigure]:VOLTage:RANGE:ELEMEnt<x>**

**Function** Sets voltage range for the specified element/queries the current setting.

**Syntax** [CONFigure]:VOLTage:RANGE:ELEMEnt<x> {<Voltage>}  
[CONFigure]:VOLTage:RANGE:ELEMEnt<x>?  
<x>=1,3(3-phase 3-wire model)  
1 to 3(3-phase 4-wire model)  
<Voltage>=10V to 600V(10,15,30,60,100,150,300,600V)

**Example** CONFIGURE:VOLTAGE:RANGE:ELEMENT1 600V  
CONFIGURE:VOLTAGE:RANGE:ELEMENT1?->:CONFIGURE:VOLTAGE:RANGE:ELEMENT1 600.0E+00

**[:CONFigure]:WIRing**

**Function** Sets wiring system/queries the current setting.

**Syntax** [CONFigure]:WIRing {P1W2|P1W3|P3W3|P3W4|V3A3}  
[CONFigure]:WIRing?

**Example** CONFIGURE:WIRING P1W2  
CONFIGURE:WIRING?->:CONFIGURE:WIRING P1W2

**Description**

- P1W2 : 1-phase 2-wire system
- P1W3 : 1-phase 3-wire system
- P3W3 : 3-phase 3-wire system
- P3W4 : 3-phase 4-wire system (possible only for the 3-phase 4-wire model)
- V3A3 : 3-voltage 3-ampere system (possible only for the 3-phase 4-wire model)

**2.3.5 DISPLAY Group**

The commands in the DISPLAY group are used to make settings relating to and inquire about display. This allows you to make the same settings and inquiries which you can make using the FUNCTION and ELEMENT keys.

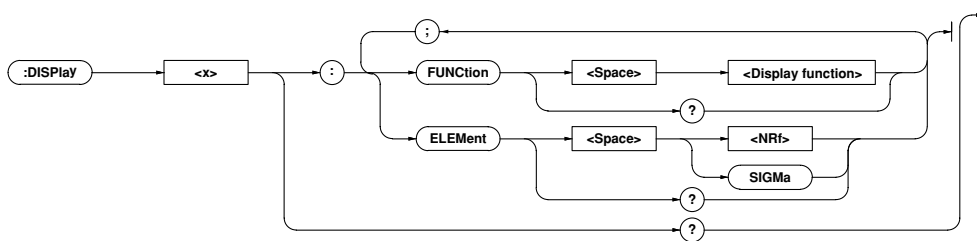

**DISPlay<x>?**

**Function** Queries all the current display settings for the specified display.

**Syntax** DISPlay<x>?  
<x>=1 to 4

- 1:Display A
- 2:Display B
- 3:Display C
- 4:Display D

**Example** DISPLAY1?->:DISPLAY1:FUNCTION V;ELEMENT 1

**DISPlay<x>:ELEMENT**

**Function** Sets the element to be displayed/queries the current setting.

**Syntax** DISPlay<x>:ELEMENT {<NRf>|SIGMa}  
DISPlay<x>:ELEMENT?  
{<NRf>}=1,3 (3-phase 3-wire model)  
1 to 3 (3-phase 4-wire model)

**Example** DISPLAY1:ELEMENT 1  
DISPLAY1:ELEMENT?->:DISPLAY1:ELEMENT 1

**Description** To set the element to be displayed during flicker measurement, use the FLICKer:DISPlay:ELEMent command.

**DISPlay<x>:FUNCTION**

**Function** Sets the function to be displayed/queries the current setting.

**Syntax** DISPlay<x>:FUNCTION {<Display function>}  
DISPlay<x>:FUNCTION?

**• During normal measurement**

<Display function>={V|A|W|VA|VAR|PF|DEG|VPK|AP  
K|VHZ|AHZ|WH|WHP|WHM|AH|AHP  
|AHM|MATH|TIME}

**• During harmonic analysis**

<Display function>={V|A|W|VA|VAR|PF|DEG|VHZ|AH  
Z|VTHD|ATHD|VDEG|ADEG}

**Example** DISPLAY1:FUNCTION V  
DISPLAY1:FUNCTION?->:DISPLAY1:FUNCTION V

**Description** To set the function to be displayed during flicker measurement, use the FLICKer:DISPlay:FUNctIon command.

### 2.3.6 FLICKer Group

The commands in the FLICKer Group are used to make settings relating to and inquiring about voltage fluctuation/flicker measurement. This allows you to make the same settings and inquiries which can be made using the FLICKER, START/STOP, INITIAL (SHIFT + START/STOP) and LIMIT (SHIFT + FLICKER) keys of the FLICKER TEST section on the front panel. These commands are available if the instrument is equipped with the flicker measurement function (/FL model).

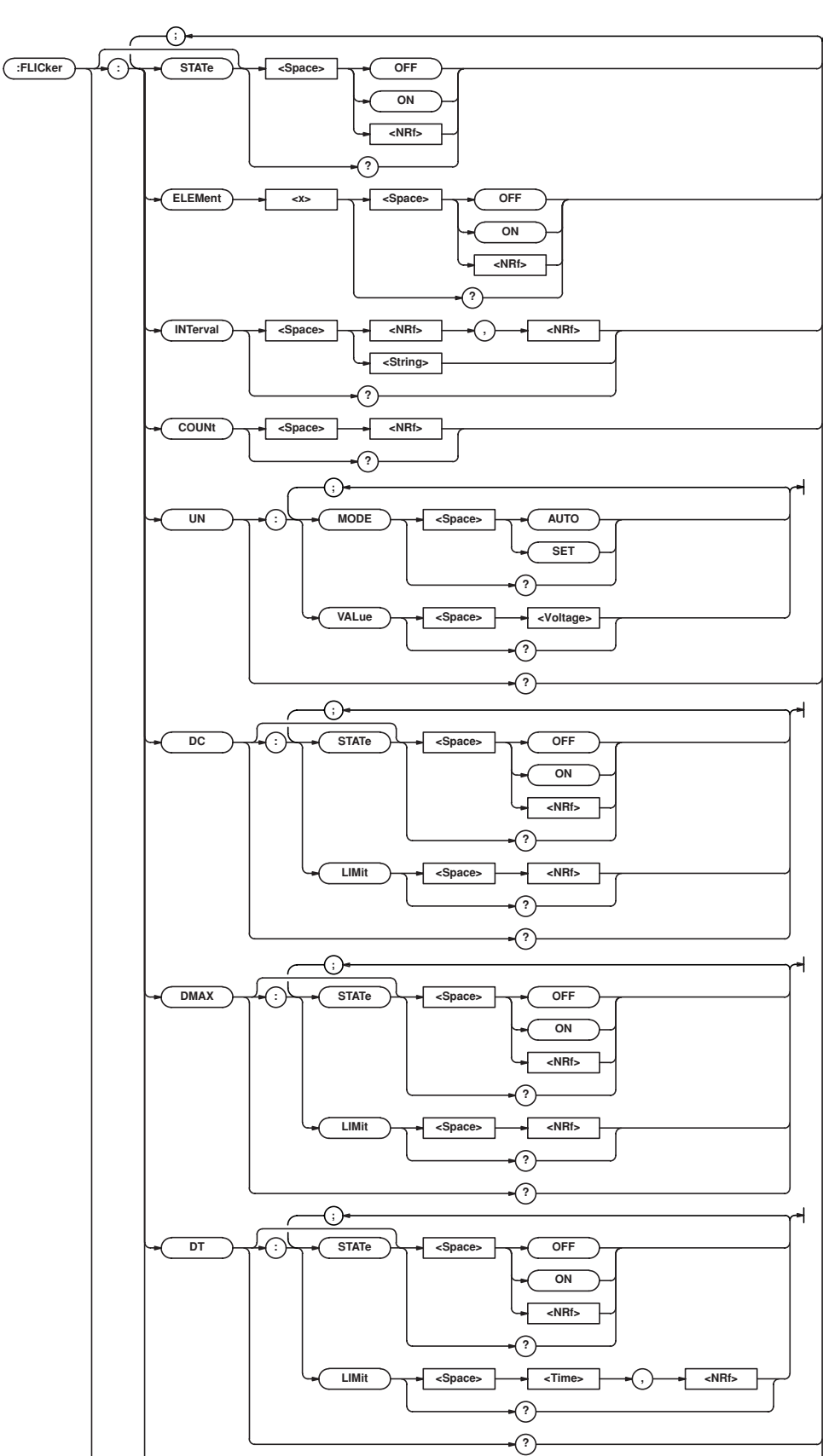

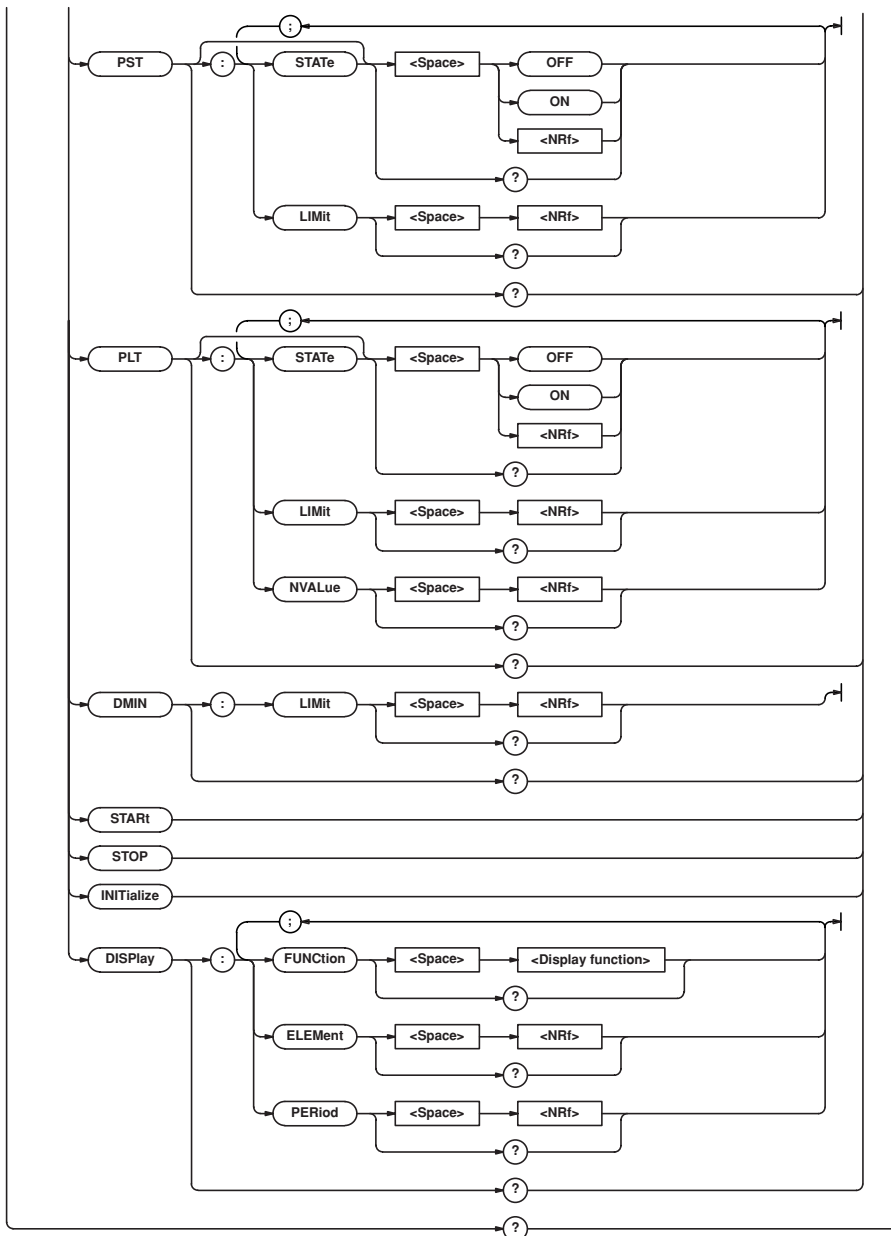

**FLICKer?**

**Function** Queries all the voltage fluctuation/flicker measurement settings.

**Syntax** FLICKer?

**Example** FLICKER?→:FLICKER:STATE 1;ELEMENT1 1;ELEMENT2 0;ELEMENT3 0;INTERVAL 10, 0;COUNT 12;UN:MODE AUTO;VALUE 2 30.00E+00;;FLICKER:DC:STATE 1;LIMIT 3.00E+00;;FLICKER:DMAX:STATE 1;LIMIT 4.00E+00;;FLICKER:DT:STATE 1;LIMIT 0.200E+00, 3.00E+00;;FLICKER:PST:STATE 1;LIMIT 1.00E+00;;FLICKER:PLT:STATE 1;LIMIT 0.65E+00;NVALUE 12;;FLICKER:DMIN:LIMIT 0.10E+00;;FLICKER:DISPLAY:FUNCTION UN;ELEMENT 1;PERIOD 1

**FLICKer:COUNT**

**Function** Sets the number of times measurement of short-term flicker value Pst is to be performed/queries the current setting.

**Syntax** FLICKer:COUNT {<NRf>}

FLICKer:COUNT? {<NRf>}=1 to 99

**Example** FLICKER:COUNT 12

FLICKER:COUNT?→:FLICKER:COUNT 12

**FLICKer:DC?**

**Function** Queries all the relative steady-state voltage change (dc) settings.

**Syntax** FLICKer:DC?

**Example** FLICKER:DC?→:FLICKER:DC:STATE 1;LIMIT 3.00E+00

**FLICKer:DC:LIMit**

**Function** Sets the limit for relative steady-state voltage change dc/queries the current setting.

**Syntax** FLICKer:DC:LIMit {<Nrf>}  
FLICKer:DC:LIMit?  
{<Nrf>}=1.00 to 99.99

**Example** FLICKER:DC:LIMIT 3.00  
FLICKER:DC:LIMIT?→:FLICKER:DC:LIMIT  
3.00E+00

**FLICKer:DC[:STATe]**

**Function** Sets whether or not relative steady-state voltage change dc be used as judgment item/queries the current setting.

**Syntax** FLICKer:DC[:STATe] {<Boolean>}  
FLICKer:DC:STATe?

**Example** FLICKER:DC:STATE ON  
FLICKER:DC:STATE?→:FLICKER:DC:STATE 1

**FLICKer:DISPlay?**

**Function** Queries all the flicker measurement display settings.

**Syntax** FLICKer:DISPlay?  
**Example** FLICKER:DISPLAY?→:FLICKER:DISPLAY:  
FUNCTION UN;ELEMENT 1;PERIOD 1

**FLICKer:DISPlay:ELEment**

**Function** Sets the element to be displayed during flicker measurement mode/queries the current setting.

**Syntax** FLICKer:DISPlay:ELEment {<Nrf>}  
FLICKer:DISPlay:ELEment?  
{<Nrf>}=1, 3(3-phase 3-wire model)  
=1 to 3(3-phase 4-wire model)

**Example** FLICKER:DISPLAY:ELEMENT 1  
FLICKER:DISPLAY:ELEMENT?→:FLICKER:  
DISPLAY:ELEMENT 1

**FLICKer:DISPlay:FUNCTion**

**Function** Sets the function to be displayed during flicker measurement mode/queries the current setting.

**Syntax** FLICKer:DISPlay:FUNCTion{<Display  
function>}  
FLICKer:DISPlay:FUNCTion?  
<Display function>={UN|DC|DMAX|DT|PST|PLT|TOTAL}

**Example** FLICKER:DISPLAY:FUNCTION UN  
FLICKER:DISPLAY:FUNCTION?→:FLICKER:  
DISPLAY:FUNCTION UN

**FLICKer:DISPlay:PERiod**

**Function** Sets the observation period no. to be displayed during flicker measurement/queries the current setting.

**Syntax** FLICKer:DISPlay:PERiod {<Nrf>}  
FLICKer:DISPlay:PERiod?  
{<Nrf>}=1 to 99

**Example** FLICKER:DISPLAY:PERIOD 1  
FLICKER:DISPLAY:PERIOD?→:FLICKER:  
DISPLAY:PERIOD 1

**FLICKer:DMAX?**

**Function** Queries all the maximum relative voltage change dmax settings.

**Syntax** FLICKer:DMAX?  
**Example** FLICKER:DMAX?→:FLICKER:DMAX:STATE 1;LIMIT  
4.00E+00

**FLICKer:DMAX:LIMit**

**Function** Sets the limit for maximum relative voltage change dmax/queries the current setting.

**Syntax** FLICKer:DMAX:LIMit {<Nrf>}  
FLICKer:DMAX:LIMit?  
{<Nrf>}=1.00 to 99.99

**Example** FLICKER:DMAX:LIMIT 4.00  
FLICKER:DMAX:LIMIT?→:FLICKER:DMAX:LIMIT  
4.00E+00

**FLICKer:DMAX [:STATe]**

**Function** Sets whether or not maximum relative voltage change dmax be used as judgment item/queries the current setting.

**Syntax** FLICKer:DMAX[:STATe] {<Boolean>}  
FLICKer:DMAX:STATe?

**Example** FLICKER:DMAX:STATE ON  
FLICKER:DMAX:STATE?→:FLICKER:DMAX:STATE 1

**FLICKer:DMIN?**

**Function** Queries all the steady-state range dmin settings.

**Syntax** FLICKer:DMIN?  
**Example** FLICKER:DMIN?→:FLICKER:DMIN:LIMIT  
0.10E+00

**FLICKer:DMIN:LIMit**

**Function** Sets the limit for steady-state range dmin/queries the current setting.

**Syntax** FLICKer:DMIN:LIMit {<Nrf>}  
FLICKer:DMIN:LIMit?  
{<Nrf>}=0.10 to 9.99

**Example** FLICKER:DMIN:LIMIT 0.10  
FLICKER:DMIN:LIMIT?→:FLICKER:DMIN:LIMIT  
0.10E+00

**FLICKer:DT?**

**Function** Queries all the settings regarding period d(t)<sub>200ms</sub> during which relative voltage change exceeds the threshold level during a voltage change.

**Syntax** FLICKer:DT?  
**Example** FLICKER:DT?→:FLICKER:DT:STATE 1;LIMIT  
0.200E+00, 3.00E+00

**FLICKer:DT:LIMit**

**Function** Sets the limit for the period d(t)<sub>200ms</sub> during which relative voltage change exceeds the threshold level during a voltage change/queries the current setting.

**Syntax** FLICKer:DT:LIMit {<Time>, <Nrf>}  
FLICKer:DT:LIMit?  
<Time>=1 to 99999(msec)  
{<Nrf>}=1.00 to 99.99

**Example** FLICKER:DT:LIMIT 200MS, 3.00  
FLICKER:DT:LIMIT?→:FLICKER:DT:LIMIT  
0.200E+00, 3.00E+00

### FLICKer:DT[:STATE]

**Function** Sets whether or not period d (t)<sub>200ms</sub> during which relative voltage change exceeds the threshold level during a voltage change be used as judgment item/queries the current setting.

**Syntax** FLICKer:DT[:STATE] {<Boolean>}  
FLICKer:DT:STATE?

**Example** FLICKER:DT:STATE ON  
FLICKER:DT:STATE?→:FLICKER:DT:STATE 1

### FLICKer:ELEMent<x>

**Function** Sets the element for which flicker measurement is to be performed/queries the current setting.

**Syntax** FLICKer:ELEMent<x> {<Boolean>}  
FLICKer:ELEMent<x>?  
<x>=1, 3(3-phase 3-wire model)  
1 to 3(3-phase 4-wire model)

**Example** FLICKER:ELEMENT1 ON  
FLICKER:ELEMENT1?→:FLICKER:ELEMENT1 1

### FLICKer:INITialize

**Function** Resets judgment result and performs measurement of rated voltage.

**Syntax** FLICKer:INITialize

**Example** FLICKER:INITIALIZE

### FLICKer:INTerval

**Function** Sets the time required for one measurement of short-term flicker value Pst/queries the current setting.

**Syntax** FLICKer:INTerval {<Nrf>, <Nrf>|<Character string>}  
FLICKer:INTerval?  
{<Nrf>, <Nrf>}=0,30 to 59,58(Minute, Second)  
<Character string>="MM:SS"(MM: Minute, SS: Second)

**Example** FLICKER:INTERVAL 10,0  
FLICKER:INTERVAL "10:00"  
FLICKER:INTERVAL?→:FLICKER:INTERVAL 10,0

**Description** Sets seconds in even values. If an odd value, "-1" will be deducted from the set value to make it an even value. For instance, if an attempt to set 31 seconds is made, it will be replaced by a setting of 30 seconds.

### FLICKer:PLT?

**Function** Queries all the long-term flicker value Plt settings/queries the current setting.

**Syntax** FLICKer:PLT?

**Example** FLICKER:PLT?→:FLICKER:PLT:STATE 1;LIMIT  
0.65E+00;NVALUE 12

### FLICKer:PLT:LIMit

**Function** Sets the limit for long-term flicker value Plt/queries the current setting.

**Syntax** FLICKer:PLT:LIMit {<Nrf>}  
FLICKer:PLT:LIMit?  
{<Nrf>}=0.10 to 99.99

**Example** FLICKER:PLT:LIMIT 0.65  
FLICKER:PLT:LIMIT?→:FLICKER:PLT:LIMIT  
0.65E+00

### FLICKer:PLT:NVALue

**Function** Sets N value for long-term flicker value Plt/queries the current setting.

**Syntax** FLICKer:PLT:NVALue {<Nrf>}  
FLICKer:PLT:NVALue?  
{<Nrf>}=1 to 99

**Example** FLICKER:PLT:NVALUE 12  
FLICKER:PLT:NVALUE?→:FLICKER:PLT:NVALUE  
12

### FLICKer:PLT[:STATE]

**Function** Sets whether or not long-term flicker value Plt be used as judgment item/queries the current setting.

**Syntax** FLICKer:PLT[:STATE] {<Boolean>}  
FLICKer:PLT:STATE?

**Example** FLICKER:PLT:STATE ON  
FLICKER:PLT:STATE?→:FLICKER:PLT:STATE 1

### FLICKer:PST?

**Function** Queries all the short-term flicker value Pst settings/queries the current setting.

**Syntax** FLICKer:PST?

**Example** FLICKER:PST?→:FLICKER:PST:STATE 1;LIMIT  
1.00E+00

### FLICKer:PST:LIMit

**Function** Sets the limit for short-term flicker value Pst/queries the current setting.

**Syntax** FLICKer:PST:LIMit {<Nrf>}  
FLICKer:PST:LIMit?  
{<Nrf>}=0.10 to 99.99

**Example** FLICKER:PST:LIMIT 1.00  
FLICKER:PST:LIMIT?→:FLICKER:PST:LIMIT  
1.00E+00

### FLICKer:PST[:STATE]

**Function** Sets whether or not short-term flicker value Pst be used as judgment item/queries the current setting.

**Syntax** FLICKer:PST[:STATE] {<Boolean>}  
FLICKer:PST:STATE?

**Example** FLICKER:PST:STATE ON  
FLICKER:PST:STATE?→:FLICKER:PST:STATE 1

### FLICKer:START

**Function** Registers rated voltage and starts measurement of voltage fluctuation.

**Syntax** FLICKer:START

**Example** FLICKER:START

### FLICKer[:STATE]

**Function** Turns flicker measurement mode ON or OFF/queries the current setting.

**Syntax** FLICKer[:STATE] {<Boolean>}  
FLICKer:STATE?

**Example** FLICKER:STATE ON  
FLICKER:STATE?→:FLICKER:STATE 1

**FLICKer:STOP**

**Function** Stops measurement of voltage fluctuation and displays judgment result.

**Syntax** FLICKer:STOP

**Example** FLICKER:STOP

**FLICKer:UN?**

**Function** Queries all the nominal voltage Un settings.

**Syntax** FLICKer:UN?

**Example** FLICKER:UN?→:FLICKER:UN:MODE AUTO;VALUE  
230.00E+00

**FLICKer:UN:MODE**

**Function** Sets the acquisition method for nominal voltage Un/queries the current setting.

**Syntax** FLICKer:UN:MODE {AUTO|SET}

FLICKer:UN:MODE?

**Example** FLICKER:UN:MODE AUTO

FLICKER:UN:MODE?→:FLICKER:UN:MODE AUTO

**Description**

Description of each acquisition method is given below.

AUTO : Uses the voltage value measured at the start of voltage fluctuation measurement .

SET : Uses the existing value (the value set by the FLICKer:UN:VALue command).

**FLICKer:UN:VALue**

**Function** Sets the existing value for nominal voltage Un/queries the current setting.

**Syntax** FLICKer:UN:VALue {<Voltage>}

FLICKer:UN:VALue?

{<Voltage>}=0.01 to 999.99

**Example** FLICKER:UN:VALUE 230V

FLICKER:UN:VALUE?→:FLICKER:UN:VALUE  
230.00E+00



### 2.3.7 HARMonics Group

The commands in the HARMonics group are used to make settings relating to and to inquire about harmonic analysis. This allows you to make the same settings and inquiries which can be made using the ANALYZE (HARMONICS) and SET UP keys on the front panel. These commands are available if the instrument is equipped with the harmonic analysis function (/HRM model).

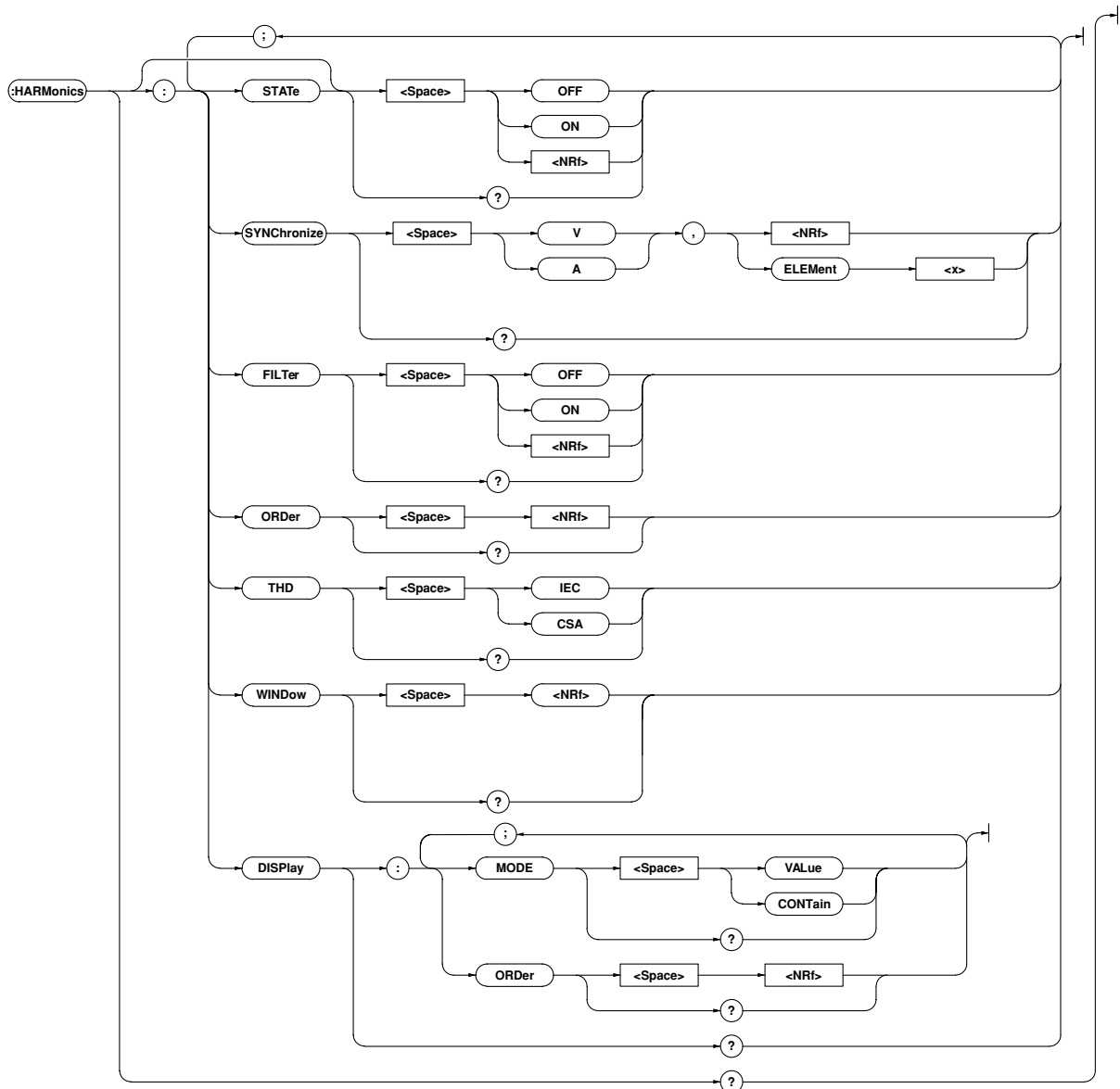

#### HARMonics?

**Function** Queries all the harmonic analysis settings.

**Syntax** HARMonics?

**Example** HARMONICS?→:HARMONICS:STATE 0;SYNCHRONIZE V,1;FILTER 0;ORDER 50;THD IEC;WINDOW 16;DISPLAY:MODE VALUE;ORDER 1

#### HARMonics:DISPlay?

**Function** Queries all the display settings for harmonic analysis.

**Syntax** HARMonics:DISPlay?

**Example** HARMONICS:DISPLAY?→:HARMONICS:DISPLAY:MODE MODE VALUE;ORDER 1

#### HARMonics:DISPlay:MODE

**Function** Sets display mode for harmonic analysis items (V, A, W) to be displayed on display B/queries the current setting.

**Syntax** HARMonics:DISPlay:MODE {VALue|CONTain} HARMonics:DISPlay:MODE?

{VALue|CONTain}={Analysis value (measured value) display | Content display}

**Example** HARMONICS:DISPLAY:MODE VALUE HARMONICS:DISPLAY:MODE?→:HARMONICS:DISPLAY:MODE VALUE

**HARMonics:DISPlay:ORDER**

**Function** Sets harmonic order to be displayed on display A/queries the current setting.

**Syntax** `HARMonics:DISPlay:ORDER {<NRf>}`  
`HARMonics:DISPlay:ORDER?`  
`{<NRf>}=1 to 50`

**Example** `HARMONICS:DISPLAY:ORDER 1`  
`HARMONICS:DISPLAY:ORDER?→:HARMONICS`  
`:DISPLAY:ORDER 1`

**HARMonics:FILTer**

**Function** Turns anti-aliasing filter for harmonic analysis ON or OFF/queries the current setting.

**Syntax** `HARMonics:FILTer {<Boolean>}`  
`HARMonics:FILTer?`

**Example** `HARMONICS:FILTER OFF`  
`HARMONICS:FILTER?→:HARMONICS:FILTER 0`

**HARMonics:ORDer**

**Function** Sets the maximum harmonic order for harmonic analysis / queries the current setting.

**Syntax** `HARMonics:ORDer {<NRf>}`  
`HARMonics:ORDer?`  
`{<NRf>}=1 to 50`

**Example** `HARMONICS:ORDER 50`  
`HARMONICS:ORDER?→:HARMONICS:ORDER 50`

**HARMonics[:STATe]**

**Function** Turns harmonic analysis mode ON or OFF/queries the current setting.

**Syntax** `HARMonics[:STATe] {<Boolean>}`  
`HARMonics:STATe?`

**Example** `HARMONICS:STATE OFF`  
`HARMONICS:STATE?→:HARMONICS:STATE 0`

**HARMonics:SYNChronize**

**Function** Sets the input (PLL source) to be used as the fundamental frequency for PLL synchronization/queries the current setting.

**Syntax** `HARMonics:SYNChronize{ (V|A), (<NRf> |`  
`ELEMent<1-3>)}`  
`HARMonics:SYNChronize?`

**Example** `HARMONICS:SYNCHRONIZE V,1`  
`HARMONICS:SYNCHRONIZE?→:HARMONICS:`  
`SYNCHRONIZE V,1`

**HARMonics:THD**

**Function** Sets the equation to be used for harmonic distortion (VTHD, ATHD)/queries the current setting.

**Syntax** `HARMonics:THD {IEC|CSA}`  
`HARMonics:THD?`

**Example** `HARMONICS:THD IEC`  
`HARMONICS:THD?→:HARMONICS:THD IEC`

**HARMonics:WINDow**

**Function** Sets the window width for harmonic analysis/queries the current setting.

**Syntax** `HARMonics:WINDow {<NRf>}`  
`HARMonics:WINDow?`  
`{<NRf>}=1, 2, 4, 8, 16`

**Example** `HARMONICS:WINDOW 16`  
`HARMONICS:WINDOW?→:HARMONICS:WINDOW 16`

### 2.3.8 INTEGrate Group

The commands in the INTEGrate group are used to make settings relating to and to inquire about integration function. This allows you to make the same settings and inquiries which can be made using the INTEGRATOR keys (START, STOP, RESET and MODE keys) on the front panel.

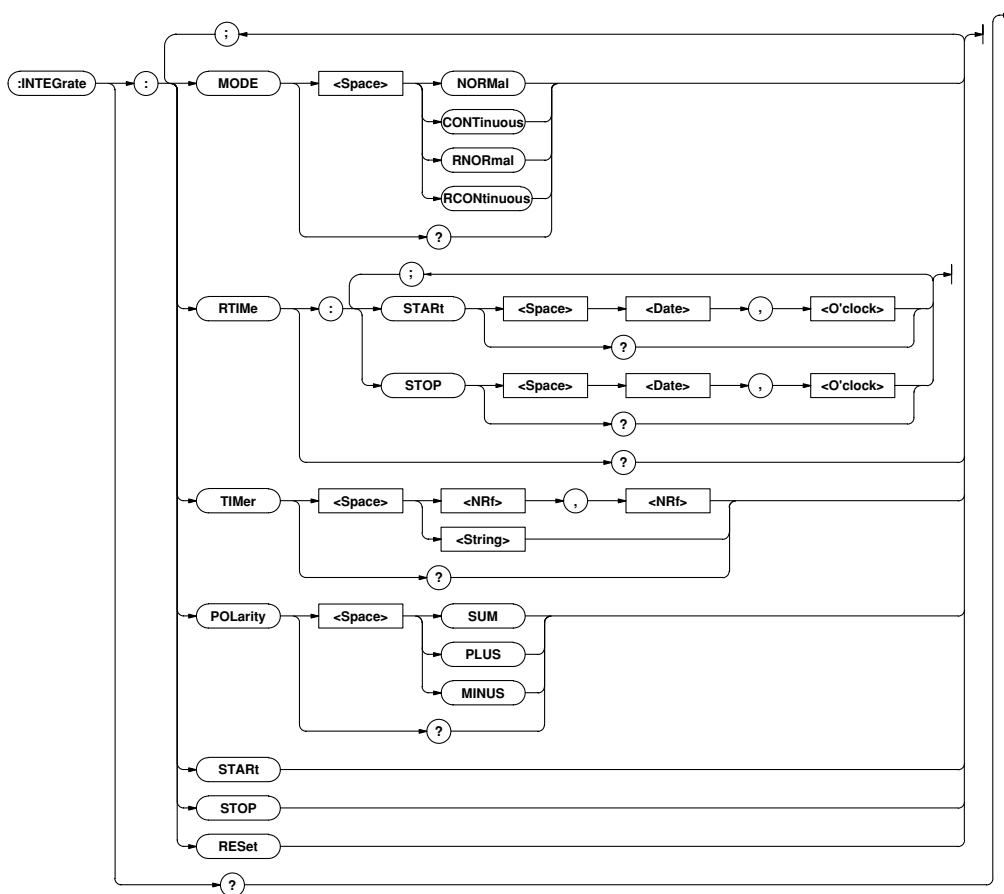

#### INTEGrate?

**Function** Queries all the integration settings.

**Syntax** INTEGrate?

**Example** INTEGrate?→:INTEGRATE:MODE NORMAL;RTIME:START 96,4,1,17,35,0;STOP96,4,3,19,35,0;:INTEGRATE:TIMER 10,0;POLARITY SUM

#### INTEGrate:MODE

**Function** Sets integration mode/queries the current setting.

**Syntax** INTEGrate:MODE{NORMAL|CONTInuous|RNORmal|RCONtinuous}  
INTEGrate:MODE?

**Example** INTEGrate:MODE NORMAL  
INTEGrate:MODE?→:INTEGRATE:MODE NORMAL

**Description** Selectable modes are given below.

- NORMal : Standard integration mode
- CONTInuous : Continuous integration mode
- RNORmal : Real time counting standard integration mode RCONtinuous
- RCONtinuous : Real time counting continuous integration mode

#### INTEGrate:POLarity

**Function** Sets polarity of integrated values to be displayed on display D/ queries the current setting.

**Syntax** INTEGrate:POLarity {SUM|PLUS|MINUS}  
INTEGrate:POLarity?

**Example** INTEGrate:POLARITY SUM  
INTEGrate:POLARITY?→:INTEGRATE:POLARITY SUM

#### INTEGrate:RESet

**Function** Resets integrated values.

**Syntax** INTEGrate:RESet  
**Example** INTEGrate:RESET

#### INTEGrate:RTIME?

**Function** Queries the integration start and stop time for real time counting integration mode.

**Syntax** INTEGrate:RTIME?  
**Example** INTEGrate:RTIME?→:INTEGRATE:RTIME:START 96,4,1,17,35,0;STOP 96,4,3,19,35,0

**INTEGRate:RTIME:START**

**Function** Sets the integration start time for real time counting integration mode/queries the current setting.

**Syntax** INTEGRate:RTIME:START {<Date>,<O'clock>}  
 INTEGRate:RTIME:START?  
 <Date>={<NRf>,<NRf>,<NRf>|<Character string>}  
 <O'clock>={<NRf>,<NRf>[,<NRf>]|<Character string>}

**Example** INTEGRATE:RTIME:START 96,4,1,17,35,0  
 INTEGRATE:RTIME:START "1996/04/01","17:35:00"  
 INTEGRATE:RTIME:START?→:INTEGRATE:RTIME:START 96,4,1,17,35,0

**Description** For <Date> and <O'clock> data, refer to Section 2.3.16, "SYSTEM Group".

**INTEGRate:RTIME:STOP**

**Function** Sets the integration stop time for real time counting integration mode/queries the current setting.

**Syntax** INTEGRate:RTIME:STOP {<Date>,<O'clock>}  
 INTEGRate:RTIME:STOP?  
 <Date>={<NRf>,<NRf>,<NRf>|<Character string>}  
 <O'clock>={<NRf>,<NRf>[,<NRf>]|<Character string>}

**Example** INTEGRATE:RTIME:STOP 1996,04,03,19,35,0  
 INTEGRATE:RTIME:STOP "96/4/3","19:35:0"  
 INTEGRATE:RTIME:STOP?→:INTEGRATE:RTIME:STOP 96,4,3,19,35,0

**Description** For <Date> and <O'clock> data, refer to Section 2.3.16, "SYSTEM Group".

**INTEGRate:START**

**Function** Starts integration.

**Syntax** INTEGRate:START

**Example** INTEGRATE:START

**INTEGRate:STOP**

**Function** Stops integration.

**Syntax** INTEGRate:STOP

**Example** INTEGRATE:STOP

**INTEGRate:TIMER**

**Function** Sets integration timer preset time/queries the current setting.

**Syntax** INTEGRate:TIMER {<NRf>,<NRf>|<Character string>}  
 INTEGRate:TIMER?  
 {<NRf>,<NRf>}=0,0 to 999,59  
 {<Character string>}="HHH:MM" HHH:Hour MM:Hour

**Example** INTEGRATE:TIMER 10,0  
 INTEGRATE:TIMER "10:00"  
 INTEGRATE:TIMER?→:INTEGRATE:TIMER 10,0

### 2.3.9 MATH Group

The commands in the MATH group are used to make settings relating to and to inquire about computation. This allows you to make the same settings and inquiries which can be made using the MATH (SHIFT + >) key on the front panel.

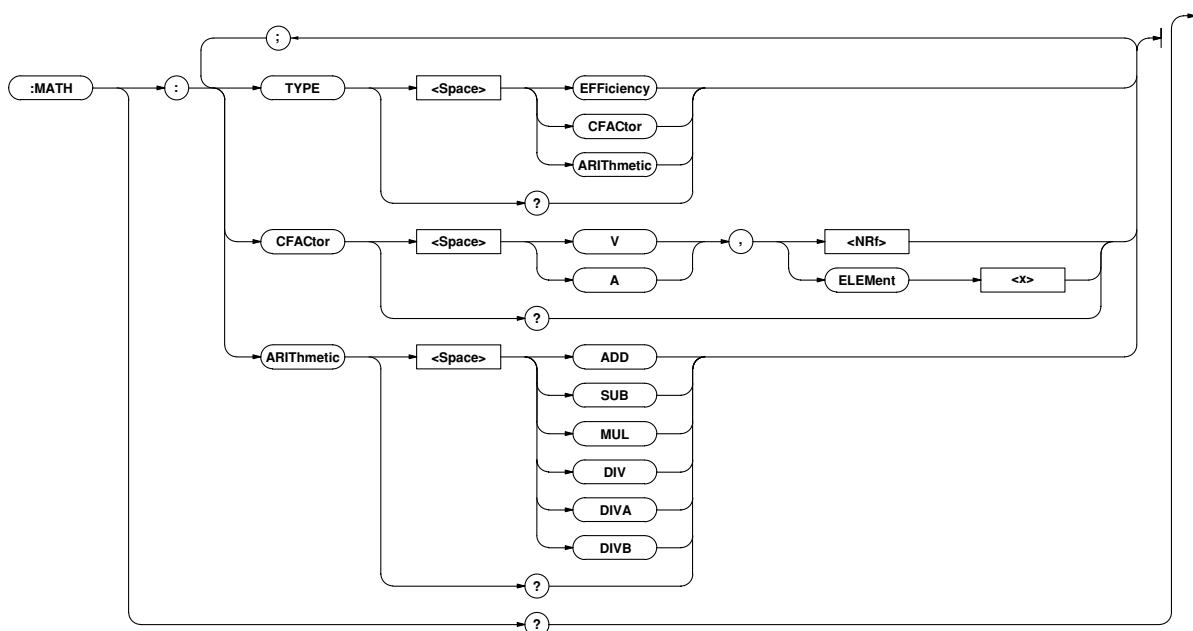

#### MATH?

**Function** Queries all the computation settings.

**Syntax** MATH?

**Example** MATH?→:MATH:TYPE EFFICIENCY

#### MATH:ARITHmetic

**Function** Sets equation for four arithmetical operations/queries the current setting.

**Syntax** MATH:ARITHmetic {ADD|SUB|MUL|DIV|DIVA|DIVB}  
MATH:ARITHmetic?

**Example** MATH:ARITHMETIC ADD

MATH:ARITHMETIC?→:MATH:ARITHMETIC ADD

**Description** "MATH:TYPE ARITHmetic" must be selected, otherwise this command is meaningless.

Description of each equation is given below.

- ADD : Display A + Display B
- SUB : Display A – Display B
- MUL : Display A \* Display B
- DIV : Display A / Display B
- DIVA : Display A / (Display B)<sup>2</sup>
- DIVB : (Display A)<sup>2</sup> / Display B

#### MATH:CFACtor

**Function** Sets equation for crest factor/queries the current setting. Sets equation for crest factor/queries the current setting.

**Syntax** MATH:CFACtor { (V|A), (<NRf>|ELEMEnt<1-3>) }  
MATH:CFACtor?

**Example** MATH:CFACtor V, 1

MATH:CFACtor?→:MATH:CFACtor V, 1

**Description** "MATH:TYPE CFACtor" must be selected, otherwise this command is meaningless.

#### MATH:TYPE

**Function** Sets computation type/queries the current setting.

**Syntax** MATH:TYPE {EFFiciency|CFACtor|ARITHmetic}  
MATH:TYPE?

**Example** MATH:TYPE EFFICIENCY

MATH:TYPE?→:MATH:TYPE EFFICIENCY

**Description** Selectable computation types are given below.

- EFFiciency : Efficiency
- CFACtor : Crest factor
- ARITHmetic : Four arithmetical operations

2.3.10 MEASure Group

The commands in the MEASure group are used to make settings relating to and to inquire about measured/computed data to be output via communication. This allows you to make the same settings and inquiries which can be made using the MISC ("co-out" menu) on the front panel.

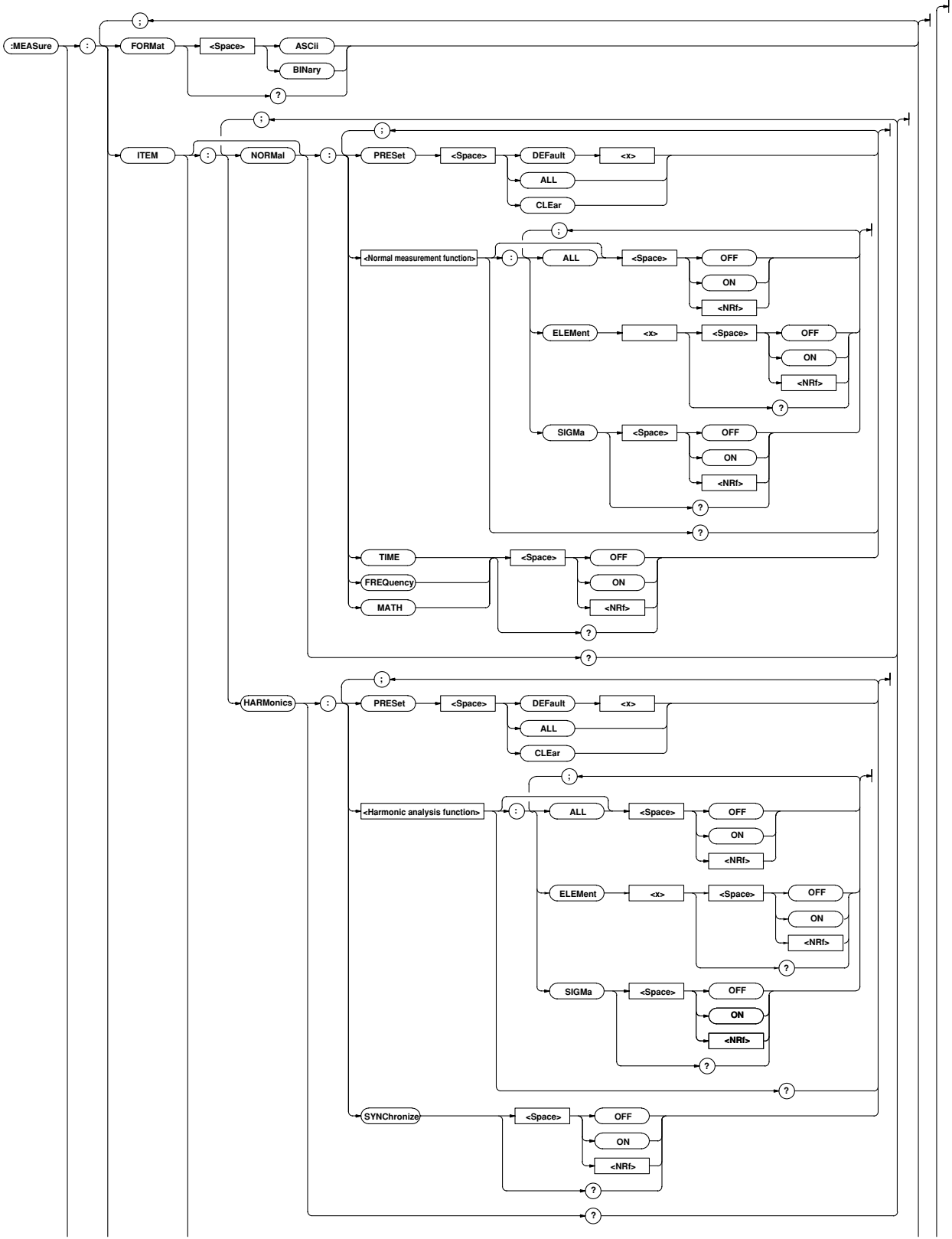

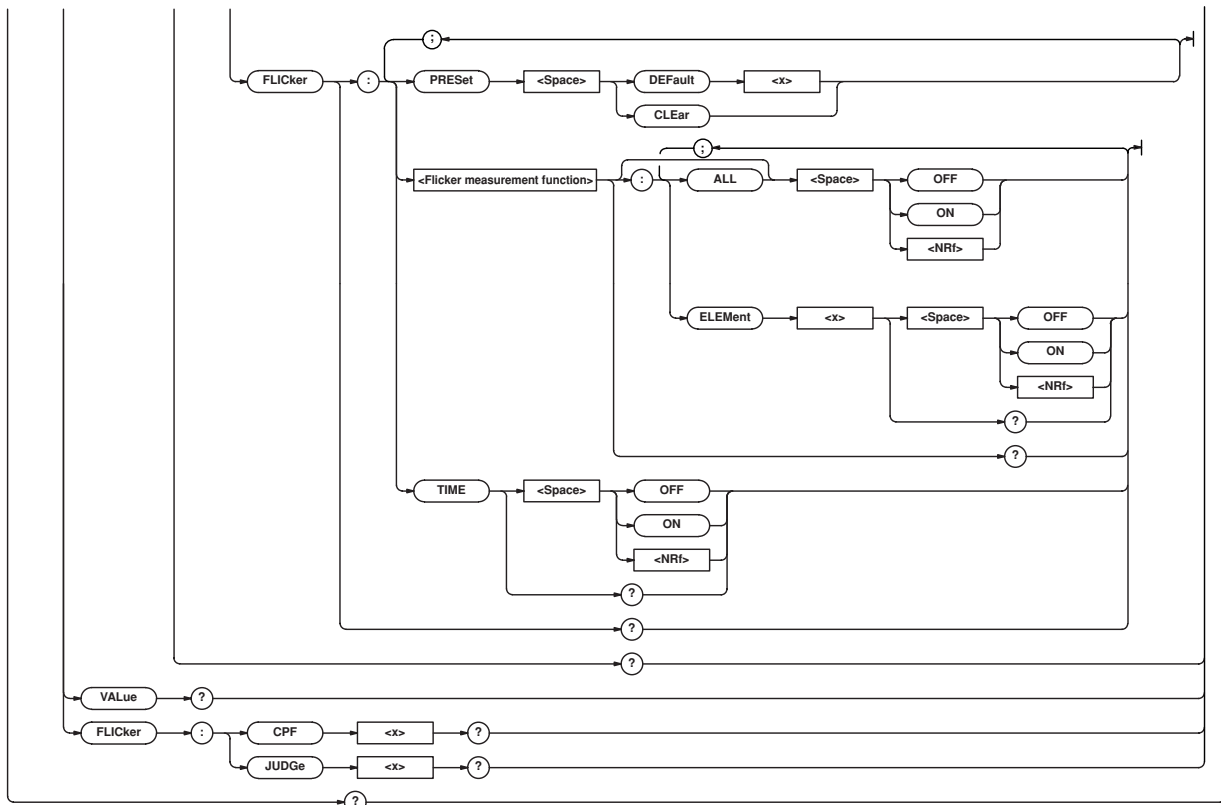

**MEASure?**

**Function** Queries all the communication output settings for measured/computed data.

**Syntax** MEASure?

**Example** MEASURE? →:MEASURE:FORMAT ASCII;(:MEASURE:" part is excluded from the response made to the MEASURE:ITEM? query command)

**MEASure:FLICKer:CPF<x>?**

**Function** Queries the CPF (cumulative probability function) data obtained during the previous flicker observation period.

**Syntax** MEASure:FLICKer:CPF<x>?

<x> indicates element.

<x>= 1, 3(3-phase 3-wire model)

1 to 3(3-phase 4-wire model)

**Example** MEASURE:FLICKER:CPF1?

→#44100ABCDEFGHIJKLMN....

**Description** CPF data is output as a block data consisting of header ("#44100" in the case of the above example) and 4100-byte binary data (1025 x 4).

For a detailed description, refer to "Output Format for CPF Data" on page App 1-25.

**MEASure:FLICKer:JUDGE<x>?**

**Function** Queries the judgment result data for each flicker observation period.

**Syntax** MEASure:FLICKer:JUDGE<x>?

<x>=1 to 99(Observation period no.)

**Example** MEASURE:FLICKER:JUDGE1?→2, 0, 0, 1.23E+00, 2.34E+00.....

**Description** "MEASURE:VALue?" queries the latest measured data for the current observation period, whilst "MEASURE:FLICKer:JUDGE<x>?" queries the measured data obtained during past observation periods. However, the output format is the same.

**MEASure:FORMat**

**Function** Sets communication output format for measured/computed data/queries the current setting.

**Syntax** MEASure:FORMat {ASCIi|BINArY}

MEASure:FORMat?

**Example** MEASURE:FORMAT ASCII

MEASURE:FORMAT?→:MEASURE:FORMAT ASCII

**MEASure:ITEM?**

**Function** Queries all the communication output items settings for measured/computed data.

**Syntax** MEASure:ITEM?

**Example** MEASURE:ITEM?→(Response to MEASURE:ITEM:NORMAL?);(Response to MEASURE:ITEM:HARMONICS?);(Response to MEASURE:ITEM:FLICKer?)

**MEASure:ITEM:FLICKer?**

**Function** Queries all the communication output items for flicker measurement.

**Syntax** MEASure:ITEM:FLICKer?

**Example** MEASURE:ITEM:FLICKER?→:MEASURE:ITEM:FLICKER:UN:ELEMENT1 1;ELEMENT2 1;ELEMENT3 1;:MEASURE:ITEM:FLICKER:DC:ELEMENT1 1;ELEMENT2 1;ELEMENT3 1;:MEASURE:ITEM:FLICKER:DMAX:ELEMENT1 1;ELEMENT2 1;ELEMENT3 1;:MEASURE:ITEM:FLICKER:DT:ELEMENT1 1;ELEMENT2 1;ELEMENT3 1;:MEASURE:ITEM:FLICKER:PST:ELEMENT1 1;ELEMENT2 1;ELEMENT3 1;:MEASURE:ITEM:FLICKER:PLT:ELEMENT1 1;ELEMENT2 1;ELEMENT3 1;:MEASURE:ITEM:FLICKER:TOTAL:ELEMENT1 1;ELEMENT2 1;ELEMENT3 1;:MEASURE:ITEM:FLICKER:VHZ:ELEMENT1 1;ELEMENT2 1;ELEMENT3 1;:MEASURE:ITEM:FLICKER:TIME 1

**MEASure:ITEM:FLICKer<flicker measurement function>**

**Function** Queries all the communication output settings for the specified flicker measurement function.

**Syntax** MEASure:ITEM:FLICKer:<Flicker measurement function>?

<Flicker measurement function>=  
{UN|DC|DMAX|DT|PST|PL T|TOTAL|VHZ}

**Example** MEASURE:ITEM:FLICKER:UN?→:MEASURE:ITEM:FLICKER:UN:ELEMENT1 1;ELEMENT2 1;ELEMENT3 1

**MEASure:ITEM:FLICKer<flicker measurement function>:[ALL]**

**Function** Turns communication output for the specified flicker measurement function ON or OFF for all the valid elements at once.

**Syntax** MEASure:ITEM:FLICKer:<Flicker measurement function>[:ALL] {<Boolean>}

**Example** MEASURE:ITEM:FLICKER:UN:ALL ON

**MEASure:ITEM:FLICKer<flicker measurement function>:ELEMENT<x>**

**Function** Turns communication output for the specified flicker measurement function ON or OFF for the specified element.

**Syntax** MEASure:ITEM:FLICKer:<Flicker measurement function>:ELEMENT<x> {<Boolean>}

MEASure:ITEM:FLICKer:<Flicker measurement function>:ELEMENT<x>?

<x>= 1, 3(3-phase 3-wire model)  
1 to 3(3-phase 4-wire model)

**Example** MEASURE:ITEM:FLICKER:UN:ELEMENT1 ON  
MEASURE:ITEM:FLICKER:UN:ELEMENT1?→  
:MEASURE:ITEM:FLICKER:UN:ELEMENT1 1

**MEASure:ITEM:FLICKer:TIME**

**Function** Turns communication output of the elapsed time of voltage fluctuation measurement ON or OFF/queries the current setting.

**Syntax** MEASure:ITEM:FLICKer:TIME

MEASure:ITEM:FLICKer:TIME?

**Example** MEASURE:ITEM:FLICKER:TIME ON  
MEASURE:ITEM:FLICKER:TIME?→:MEASURE:ITEM:FLICKER:TIME 1

**MEASure:ITEM:FLICKer:PRESet**

**Function** Sets the communication output items for flicker measurement mode to the specified default setting at once.

**Syntax** MEASure:ITEM:FLICKer:PRESet {DEFAULT<1-2>|ALL|CLEAR}

**Example** MEASURE:ITEM:FLICKER:PRESET DEFAULT1

**Description** • For a detailed description of default setting, refer to 14.1 "Selecting the Output Items".

**MEASure:ITEM:HARMONics?**

**Function** Queries all the communication output items for harmonic analysis mode.

**Syntax** MEASure:ITEM:HARMONics?

**Example** MEASURE:ITEM:HARMONICS?→:MEASURE:ITEM:HARMONICS:V:ELEMENT1 1;ELEMENT2 1;ELEMENT3 1;SIGMA 0;:MEASURE:ITEM:HARMONICS:A:ELEMENT1 1;ELEMENT2 1;ELEMENT3 1;SIGMA 0;:MEASURE:ITEM:HARMONICS:W:ELEMENT1 1;ELEMENT2 1;ELEMENT3 1;SIGMA 0;:MEASURE:ITEM:HARMONICS:VA:ELEMENT1 0;ELEMENT2 0;ELEMENT3 0;SIGMA 0;:MEASURE:ITEM:HARMONICS:VAR:ELEMENT1 0;ELEMENT2 0;ELEMENT3 0;SIGMA 0;:MEASURE:ITEM:HARMONICS:PF:ELEMENT1 0;ELEMENT2 0;ELEMENT3 0;SIGMA 0;:MEASURE:ITEM:HARMONICS:DEG:ELEMENT1 0;ELEMENT2 0;ELEMENT3 0;:MEASURE:ITEM:HARMONICS:VTHD:ELEMENT1 1;ELEMENT2 1;ELEMENT3 1;:MEASURE:ITEM:HARMONICS:ATHD:ELEMENT1 1;ELEMENT2 1;ELEMENT3 1;:MEASURE:ITEM:HARMONICS:VCON:ELEMENT1 1;ELEMENT2 1;ELEMENT3 1;:MEASURE:ITEM:HARMONICS:ACON:ELEMENT1 1;ELEMENT2 1;ELEMENT3 1;:MEASURE:ITEM:HARMONICS:WCON:ELEMENT1 1;ELEMENT2 1;ELEMENT3 1;:MEASURE:ITEM:HARMONICS:VDEG:ELEMENT1 0;ELEMENT2 0;ELEMENT3 0;:MEASURE:ITEM:HARMONICS:ADEG:ELEMENT1 0;ELEMENT2 0;ELEMENT3 0;:MEASURE:ITEM:HARMONICS:SYNCHRONIZE 1

**MEASure:ITEM:HARMONics:<Harmonic analysis function>?**

**Function** Queries all the communication output settings for the specified harmonic analysis function.

**Syntax** MEASure:ITEM:HARMONics:<Harmonic analysis function>?

<Harmonic analysis function>=  
{V|A|W|VA|VAR|PF|DEG|V|THD|ATHD|VCON|ACON|WCON|VDEG|ADEG}

**Example** MEASURE:ITEM:HARMONICS:V?→:MEASURE:ITEM:HARMONICS:V:ELEMENT1 1;ELEMENT2 1;ELEMENT3 1;SIGMA 0



### MEASure:ITEM:HARMonics:{<Harmonic analysis function>}:ALL

**Function** Turns communication output for the specified harmonic analysis function ON or OFF for all the effective elements at once.

**Syntax** MEASure:ITEM:HARMonics:<Harmonic analysis function>[:ALL] {<Boolean>}

**Example** MEASURE:ITEM:HARMONICS:V:ALL ON

### MEASure:ITEM:HARMonics:<Harmonic analysis function>:ELEMENT<x>

**Function** Turns communication output for the specified harmonic analysis function ON or OFF for the specified element/queries the current setting.

**Syntax** MEASure:ITEM:HARMonics:<Harmonic analysis function>:ELEMENT<x> {<Boolean>}  
 MEASure:ITEM:HARMonics:<Harmonic analysis function>:ELEMENT<x>?  
 <x>=1,3(3-phase 3-wire model)  
 =1 to 3(3-phase 4-wire model)

**Example** MEASURE:ITEM:HARMONICS:V:ELEMENT1 ON  
 MEASURE:ITEM:HARMONICS:V:ELEMENT1?→:MEASURE:ITEM:HARMONICS:V:ELEMENT1 1

### MEASure:ITEM:HARMonics:<Harmonic analysis function>:SIGMa

**Function** Turns communication output of  $\Sigma$  data ON or OFF for the specified harmonic analysis function/queries the current setting.

**Syntax** MEASure:ITEM:HARMonics:<Harmonic analysis function>SIGMa {<Boolean>}

**Example** MEASURE:ITEM:HARMONICS:V:SIGMA OFF  
 MEASURE:ITEM:HARMONICS:V:SIGMA?→:MEASURE:ITEM:HARMONICS:V:SIGMA 0

**Description** • The following harmonic analysis functions can be set with this command. <Harmonic analysis function>= $|V|A|W|VA|VAR|PF$

### MEASure:ITEM:HARMonics:SYNChronize

**Function** Turns communication output for PLL source ON or OFF/queries the current setting.

**Syntax** MEASure:ITEM:HARMonics:SYNChronize {<Boolean>}  
 MEASure:ITEM:HARMonics:SYNChronize?

**Example** MEASURE:ITEM:HARMONICS:SYNCHRONIZE ON  
 MEASURE:ITEM:HARMONICS:SYNCHRONIZE?→  
 MEASURE:ITEM:HARMONICS:SYNCHRONIZE 1

### MEASure:ITEM:HARMonics:PRESet

**Function** Sets communication output items for harmonic analysis mode to the preset settings at once.

**Syntax** MEASure:ITEM:HARMonics:PRESet {DEFAULT<1-2>|ALL|CLEAR}

**Example** MEASURE:ITEM:HARMONICS:PRESET DEFAULT1

**Description** For a description of global setting, refer to Section 14.1, "Selecting the Output Items".

### MEASure:ITEM:NORMal?

**Function** Queries all the communication output items for normal measurement mode.

**Syntax** MEASure:ITEM:NORMal?

**Example** MEASURE:ITEM:NORMAL?→:MEASURE:ITEM:NORMAL:V:ELEMENT1 1;ELEMENT2 1;ELEMENT3 1;SIGMA 1;:MEASURE:ITEM:NORMAL:A:ELEMENT1 1;ELEMENT2 1;ELEMENT3 1;SIGMA 1;:MEASURE:ITEM:NORMAL:W:ELEMENT1 1;ELEMENT2 1;ELEMENT3 1;SIGMA 1;:MEASURE:ITEM:NORMAL:VA:ELEMENT1 0;ELEMENT2 0;ELEMENT3 0;SIGMA 0;:MEASURE:ITEM:NORMAL:VAR:ELEMENT1 0;ELEMENT2 0;ELEMENT3 0;SIGMA 0;:MEASURE:ITEM:NORMAL:PF:ELEMENT1 0;ELEMENT2 0;ELEMENT3 0;SIGMA 0;:MEASURE:ITEM:NORMAL:DEG:ELEMENT1 0;ELEMENT2 0;ELEMENT3 0;SIGMA 0;:MEASURE:ITEM:NORMAL:VPK:ELEMENT1 0;ELEMENT2 0;ELEMENT3 0;:MEASURE:ITEM:NORMAL:APK:ELEMENT1 0;ELEMENT2 0;ELEMENT3 0;:MEASURE:ITEM:NORMAL:WH:ELEMENT1 0;ELEMENT2 0;ELEMENT3 0;SIGMA 0;:MEASURE:ITEM:NORMAL:WHP:ELEMENT1 0;ELEMENT2 0;ELEMENT3 0;SIGMA 0;:MEASURE:ITEM:NORMAL:WHM:ELEMENT1 0;ELEMENT2 0;ELEMENT3 0;SIGMA 0;:MEASURE:ITEM:NORMAL:AH:ELEMENT1 0;ELEMENT2 0;ELEMENT3 0;SIGMA 0;:MEASURE:ITEM:NORMAL:AHP:ELEMENT1 0;ELEMENT2 0;ELEMENT3 0;SIGMA 0;:MEASURE:ITEM:NORMAL:AHM:ELEMENT1 0;ELEMENT2 0;ELEMENT3 0;SIGMA 0;:MEASURE:ITEM:NORMAL:TIME 0;FREQUENCY 1;MATH 0

### MEASure:ITEM[:NORMal]:<Normal measurement function>?

**Function** Queries all the communication output settings for the specified normal measurement function.

**Syntax** MEASure:ITEM[:NORMal]:<Normal measurement function>?  
 <Normal measurement function>={ $V|A|W|VA|VAR|PF|DEG|VPK|APK|WH|WHP|WHM|AH|AHP|AHM$ }

**Example** MEASURE:ITEM:NORMAL:V?→:MEASURE:ITEM:NORMAL:V:ELEMENT1 1;ELEMENT2 1;ELEMENT3 1;SIGMA 1

**MEASure:ITEM[:NORMal]:<Normal measurement function>[:ALL]**

**Function** Turns communication output for the specified normal measurement function ON or OFF for all the effective elements and  $\Sigma$  at once.

**Syntax** MEASure:ITEM[:NORMal]:<Normal measurement function>[:ALL] {<Boolean>}

**Example** MEASURE:ITEM:NORMAL:V:ALL ON

**MEASure:ITEM[:NORMal]:<Normal measurement function>:ELEMENT<x>**

**Function** Turns communication output for the specified normal measurement function ON or OFF for the specified element/queries the current setting.

**Syntax** MEASure:ITEM[:NORMal]:<Normal measurement function>:ELEMENT<x> {<Boolean>}  
 MEASure:ITEM[:NORMal]:<Normal measurement function>:ELEMENT<x>?  
 <x>=1,3(3-phase 3-wire model)  
 =1 to 3(3-phase 4-wire model)

**Example** MEASURE:ITEM:NORMAL:V:ELEMENT1 ON  
 MEASURE:ITEM:NORMAL:V:ELEMENT1?→:MEASURE:  
 ITEM:NORMAL:V:ELEMENT1 1

**MEASure:ITEM[:NORMal]:<Normal measurement function>:SIGMa**

**Function** Turns communication output of  $\Sigma$  data ON or OFF for the specified harmonic analysis function/queries the current setting.

**Syntax** MEASure:ITEM[:NORMal]:<Normal measurement function>:SIGMa {<Boolean>}  
 MEASure:ITEM[:NORMal]:<Normal measurement function>:SIGMa?

**Example** MEASURE:ITEM:NORMAL:V:SIGMA ON  
 MEASURE:ITEM:NORMAL:V:SIGMA?→:MEASURE:ITEM:  
 NORMAL:V:SIGMA 1

**Description** It is not possible to set VPK and APK normal measurement functions using this command.

**MEASure:ITEM[:NORMal]:{TIME|FREQuency|MATH}**

**Function** Turns communication output ON or OFF for the elapsed time of integration, frequency and computed data.

**Syntax** MEASure:ITEM[:NORMal]:{TIME|FREQuency|MATH}  
 {<Boolean>}MEASure:ITEM[:NORMal]:{TIME|FREQuency|MATH}?

**Example** MEASURE:ITEM:NORMAL:FREQUENCY ON  
 MEASURE:ITEM:NORMAL:FREQUENCY?→:MEASURE:  
 ITEM:NORMAL:FREQUENCY 1

**MEASure:ITEM[:NORMal]:PRESet**

**Function** Sets communication output items for normal measurement mode to the preset settings at once.

**Syntax** MEASure:ITEM[:NORMal]:PRESet {DEFAULT<1-2>|ALL|CLE ar}

**Example** MEASURE:ITEM:NORMAL:PRESET DEFAULT1

**Description** For a description of global setting, refer to Section 14.1, "Selecting the Output Items".

**MEASure:VALue?**

**Function** Queries all the measured/computed data for the items which are set to ON using "MEASure:ITEM" commands ("MEASure:ITEM:HARMONICS" through "MEASure:ITEM[:NORMal]:PRESet").

**Syntax** MEASure:VALue?

**Example** MEASURE:VALUE?→7.006E+00,6.386E+00,-36.68E+00,...

**Description** Measured/computed data output by this query command is updated at the rise of bit 0 (UPD) of the condition register (refer to page App 2-59). For details, refer to Section 2.2.6, "Synchronization with the Controller".

## Output/Data Format for Normal Measurement, Harmonic Analysis and Flicker Measurement

The output and data format for data obtained during normal measurement, harmonic analysis and flicker measurement modes which is output by "MEASURE:VALUE?" are described below.

### Data format for normal measurement data

- Data for <normal measurement function> is always output in <NR3> format.  
(Example) 99.99E+00  
WH, WHP, WHM, AH, AHP, AHM → Mantissa: floating-point number of the maximum 6 digits + Exponent: 2 digits  
Except for WH, WHP, WHM, AH, AHP, AHM → Mantissa: floating-point number of the maximum 5 digits + Exponent: 2 digits
- The sign for the mantissa is provided only when the value is negative. However, phase lag and phase lead for phase angle (DEG) are expressed as follows.  
(LEAD) → +180.0E+00  
(LAG) → -180.0E+00  
Not detectable → 0.0E+00 (preceded by a space)
- "9.9E+37" (+∞) is output in case of overrange or computation overflow. (-oL-, -oF-, PFErr, dEGEr, ErrLo or ErrHi is displayed.)
- "9.91E+37" (NAN) is output in case of no data ("-----" is displayed).
- For elapsed time of integration (TIME), 3 data (hour, minute and second) is output in <NR1> format. Example 999,59,59

### Output format for normal measurement data

Output format for normal measurement data for all the items which are set to ON as described in Section 14.1, "Selecting the Output Items" or using "MEASURE:ITEM[:NORMAL]" commands is output in one line at once. The order in which each data is output is given below. (Numbers indicate element numbers.)

```
V1→A1→W1→VA1→VAR1→PF1→DEG1→VPK1→APK1→
TIME→WH1→WHP1→WHM1→AH1→AHP1→AHM1→
V2→A2→W2→VA2→VAR2→PF2→DEG2→VPK2→APK2→
TIME→WH2→WHP2→WHM2→AH2→AHP2→AHM2→
V3→A3→W3→VA3→VAR3→PF3→DEG3→VPK3→APK3→
TIME→WH3→WHP3→WHM3→AH3→AHP3→AHM3→
VΣ→AΣ→WΣ→VAΣ→VARΣ→PFΣ→DEGΣ→
TIME→WHΣ→WHPΣ→WHMΣ→AHΣ→AHPΣ→AHMΣ→
FREQUENCY→MATH
```

A comma is inserted between data to separate them, and a terminator (<RMT>) is added at the end of the last data.

### Output examples for normal measurement data

- When the following commands are sent (3-phase 3-wire model)  
(Command) MEASURE:ITEM:NORMAL:PRESET DEFAULT1  
MEASURE:VALUE?  
(Received data) 5.721E+00,2.4567E+00,-10.48E+00,5.717E+00,2.4573E+00,  
-10.48E+00,5.719E+00,2.4570E+00,-20.96E+00,63.998E+00  
(Description of each received data)  
V1 :5.721E+00 A1 :2.4567E+00 W1 :-10.48E+00  
V3 :5.717E+00 A3 :2.4573E+00 W3 :-10.48E+00  
VΣ :5.719E+00 AΣ :2.4570E+00 WΣ :-20.96E+00  
FREQ:63.998E+00

- When the following commands are sent during integration

(Command) MEASURE:ITEM:NORMAL:PRESET DEFAULT2  
MEASURE:VALUE?

(Received data)

```
-10.49E+00,0,10,0,-1.7469E+00,0.0524E+00,-
1.7993E+00,409.26E-03,409.26E-03,0.00E-03,-
10.50E+00,0,10,0,-1.7500E+00,0.0523E+00,-
1.8024E+00,409.71E-03,409.71E-03,0.00E-03,-
10.48E+00,0,10,0,-1.7478E+00,0.0524E+00,-
1.8012E+00,409.20E-03,409.20E-03,0.00E-03,-
31.47E+00,0,10,0,-5.2447E+00,0.1572E+00,-
5.4029E+00,1.2282E+00,1.2282E+00,0.0000E+00,64.001E+00
```

(Description of each received data)

```
W1 : -10.49E+00
WH1 : -1.7469E+00  WHP1 : 0.0524E+00  WHM1 : -1.7993E+00
AH1 : 409.26E-03  AHP1 : 409.26E-03  AHM1 : 0.00E-03
W2 : -10.50E+00
WH2 : -1.7500E+00  WHP2 : 0.0523E+00  WHM2 : -1.8024E+00
AH2 : 409.71E-03  AHP2 : 409.71E-03  AHM2 : 0.00E-03
W3 : -10.48E+00
WH2 : -1.7478E+00  WHP3 : 0.0524E+00  WHM3 : -1.8012E+00
AH3 : 409.20E-03  AHP3 : 409.20E-03  AHM3 : 0.00E-03
WΣ : -31.47E+00
WHΣ : -5.2447E+00  WHPΣ : 0.1572E+00  WHMΣ : -5.4029E+00
AHΣ : 1.2282E+00  AHPΣ : 1.2282E+00  AHMΣ : 0.0000E+00
FREQ: 64.001E+00
lapsed time of integration: 0 (hour) 10 (minute) 0 (second)
```

**Data format for harmonic analysis data**

Data is always output in <NR3> format. (Mantissa: floating-point number of the maximum 5 digits + Exponent: 2 digits)

**Output format for harmonic analysis data**

Data for all the items which are set to ON as described in Section 14.1, "Selecting the Output Items" or using "MEASure:ITEM[:HARMonics]" commands is output in one line at once. The order in which each data is output is given below. (Numbers indicate element numbers.)

```
V1→A1→W1→
VA1→VAR1→PF1→DEG1→VTHD1→ATHD1→
VCON1→ACON1→WCON1→
VDEG1→ADEG1→
V2→A2→W2→
VA2→VAR2→PF2→DEG2→VTHD2→ATHD2→
VCON2→ACON2→WCON2→
VDEG2→ADEG2→
V3→A3→W3→
VA3→VAR3→PF3→DEG3→VTHD3→ATHD3→
VCON3→ACON3→WCON3→
VDEG3→ADEG3→
VΣ→AΣ→WΣ→VAΣ→VARΣ→PFΣ→
SYNChronize
```

The following number of data sets are output by one <harmonic analysis function> or SYNChronize (PLL source frequency).

- \* "n" is the upper limit of the harmonic order. The harmonic data above the upper limit are not outputted.
- V, A, W : n\*+1 data (1 data for V Σ, A Σ, W Σ)  
Total rms value of 1st to n\*th harmonic → Analysis value of fundamental → Analysis value of 2nd harmonic → ... → Analysis value of n\*th harmonic
- VA, VAR, PF, DEG : 1 data  
Apparent power, reactive power, power factor or phase angle of fundamental (1st) is output. Executing the HARMonics:DEGREE? query command allows you to know which object is used for phase angle.
- VTHD, ATHD : 1 data  
Harmonic distortion of voltage or current is output. (Either IEC or CSA) Executing the HARMonics:THD? query command allows you to know which equation is used.
- VCON, ACON, WCON : n\*-1 data  
Content of 2nd harmonic → .... → Content of n\*th harmonic
- VDEG : n\* data  
Phase angle of current of 1st in relation to voltage of 1s → Phase angle of voltage of 2nd in relation to voltage of 1st → Phase angle of voltage of n\*th in relation to voltage of 1st
- ADEG : n\* data  
Phase angle of current of 1st in relation to voltage of 1s → Phase angle of current of 2nd in relation to current of 1st → Phase angle of current of n\*th in relation to current of 1st
- SYNChronize (PLL source frequency): 1 data  
Executing the HARMonics:SYNChronize? query command allows you to know which PLL source is used.

A comma is inserted between data to separate them, and a terminator (<RMT>) is added at the end of the last data.

**Output examples for harmonic analysis data**

- When the following commands are sent:

```
(Command) MEASURE:ITEM:HARMONICS:PRESET CLEAR
           MEASURE:ITEM:HARMONICS:A:ELEMENT1 ON
           MEASURE:ITEM:HARMONICS:ACON:ELEMENT1 ON
           MEASURE:VALUE?
```

```
(Received data) 8.195E+00,8.136E+00,0.003E+00,0.903E+00,0.001E+00,0.326E+00,
                0.001E+00,0.168E+00,0.000E+00,0.100E+00,0.001E+00,0.067E+00,
                0.000E+00,0.049E+00,0.001E+00,0.038E+00,0.000E+00,0.028E+00,
                0.001E+00,0.022E+00,0.000E+00,0.019E+00,0.001E+00,0.016E+00,
                0.000E+00,0.013E+00,0.001E+00,0.012E+00,0.001E+00,0.010E+00,
                0.001E+00,0.011E+00,0.001E+00,0.006E+00,0.001E+00,0.006E+00,
                0.001E+00,0.006E+00,0.000E+00,0.006E+00,0.000E+00,0.006E+00,
                0.000E+00,0.005E+00,0.001E+00,0.005E+00,0.001E+00,0.005E+00,
                0.000E+00,0.003E+00,0.001E+00,0.04E+00,11.10E+00,0.01E+00,
                4.01E+00,0.02E+00,2.07E+00,0.01E+00,1.23E+00,0.01E+00,
                0.82E+00,0.00E+00,0.60E+00,0.02E+00,0.46E+00,0.00E+00,
                0.34E+00,0.01E+00,0.28E+00,0.00E+00,0.23E+00,0.01E+00,
                0.20E+00,0.00E+00,0.17E+00,0.01E+00,0.14E+00,0.01E+00,
                0.13E+00,0.01E+00,0.13E+00,0.02E+00,0.07E+00,0.01E+00,
                0.08E+00,0.01E+00,0.08E+00,0.00E+00,0.07E+00,0.01E+00,
                0.07E+00,0.00E+00,0.06E+00,0.01E+00,0.06E+00,0.01E+00,
                0.06E+00,0.00E+00,0.04E+00,0.01E+00
```

(Description of each received data)

```
Total rms value from 1st to 50th harmonic of current      : 8.195E+00 (A)
Analysis value of fundamental (1st)                       : 8.136E+00 (A)
Analysis value of 2nd harmonic                            : 0.003E+00 (A)
Analysis value of 3rd harmonic                            : 0.903E+00 (A)
...
...
Analysis value of 50th harmonic                           : 0.001E+00 (A)
Content of 2nd harmonic                                   : 0.04E+00 (%)
Content of 3rd harmonic                                   : 11.10E+00 (%)
...
...
Content of 50th harmonic                                  : 0.01E+00 (%)
```

A total of 100 data sets are output.

**Data format for flicker measurement data**

- Data for <flicker measurement function> is always output in <NR3> format. (Mantissa: floating-point number of 5 digits + Exponent: 2 digits)
- "9.9E+37" (+∞) is output in case of overrange or computation overflow (-oL-, -oF-, Err-Lo or Err-Hi is displayed).
- "9.91E+37" (NAN) is output in case of no data ("-----" is displayed).
- "9.9E+37" (+∞) is output in case of data by which relative steady-state voltage change (dc) cannot be defined ("undef" is displayed).
- In the total judgment result (TOTAL), "0.0E+00" is output for pass, "-1.0E+00" is output for fail and "-2.0E+00" is output for Judgment impossible.
- For elapsed time of voltage fluctuation measurement, 3 data (hour, minute and second) is output in <NR1> format. Example: 999, 59, 59

**Output format for flicker measurement data**

- Data for all the items which are set to ON as described in Section 14.1, "Selecting the Output Items" or using "MEASure:ITEM:FLICkEr" commands is output in one line at once. The order in which each data is output is given below. (Numbers indicates element numbers.)  
 TIME→UN(V)1→VHZ1→DC1→DMAX1→DT1→PST1→PLT1→TOTAL1→  
 TIME→UN(V)2→VHZ2→DC2→DMAX2→DT2→PST2→PLT2→TOTAL2→  
 TIME→UN(V)3→VHZ3→DC3→DMAX3→DT3→PST3→PLT3→TOTAL3→
- A command is inserted between data to separate them, and a terminator (<RMT>) is added at the end of the last data.

**Output examples for flicker measurement data**

- When the following commands are sent during measurement of voltage fluctuation  
 (Command) MEASURE:ITEM:FLICKER:PRESET DEFAULT1  
 MEASURE:VALUE?  
 (Received data) 1, 18, 56, 231.8E+00, 49.999E+00,  
 1.52E+00, 1.56E+00, 80.0E-0.3, 9.91E+37,  
 9.91E+37, 9.91E+37,  
 (Description of each received data) UN1:231.8E+00 VHZ1:49.999E+00  
 DC1:1.52E+00 DMAX1:1.56E+00  
 DT1:80.0E-0.3 PST1:9.91E+37  
 PLT1:9.91E+37 TOTAL1:9.91E+37  
 Elapsed time: 1 (hour) 18 (minute) 56 (second)  
 \* "9.91E+37" (no data) will be output if the  
 MEASURE:VALUE? is sent during measurement of  
 voltage fluctuation, since computation of PST, PLT and  
 TOTAL is not yet ready.

- When the following commands are sent during display of judgment result  
 (Command) MEASURE:ITEM:FLICKER:PRESET DEFAULT1  
 MEASURE:FLICKER:JUDGE12?  
 (Received data) 2, 0, 0, 231.8E+00, 49.999E+00,  
 1.54E+00, 1.59E+00, 80.0E-0.3, 1.18E+00,  
 0.62E+00, -1.0E+00,  
 (Description of each received data) UN1:231.8E+00 VHZ1:49.999E+00  
 DC1:1.54E+00 DMAX1:1.59E+00  
 DT1:80.0E-0.3 PST1:1.18E+00  
 PLT1:0.62E+00 TOTAL1:-1.0E+00  
 Elapsed time: 2 (hour) 0 (minute) 0 (second)

**Data format for binary data**

Refer to "Data Section" on page App 1-26.

**Output format for binary data**

Following the steps described in Section 15.1 "Selecting the Output Items" or using the "MEASure:ITEM" group command, all data which have their communication output turned ON are outputted together as block data of "4 bytes \* number of data sets."

- There is a 6-byte header in front of the block data. (Refer to App2-7 <Block data>.)
- Data of each items is output in the same order as ASCII format.
- No comma is inserted between data of each item to separate them.
- A terminator (<RMT>), which is normally added at the end of each line, is added. "EOI" becomes TRUE immediately the terminator is output.

### 2.3.11 PRINT Group

The commands in the PRINT group are used to make settings relating to and to inquire about built-in printer. This allows you to make the same settings and inquiries which you can make using the PRINTER keys (AUTO, PRINT, FEED SET UP (SHIFT + AUTO)) on the front panel. These commands are available only if the instrument is equipped with the built-in printer (/B5 model).

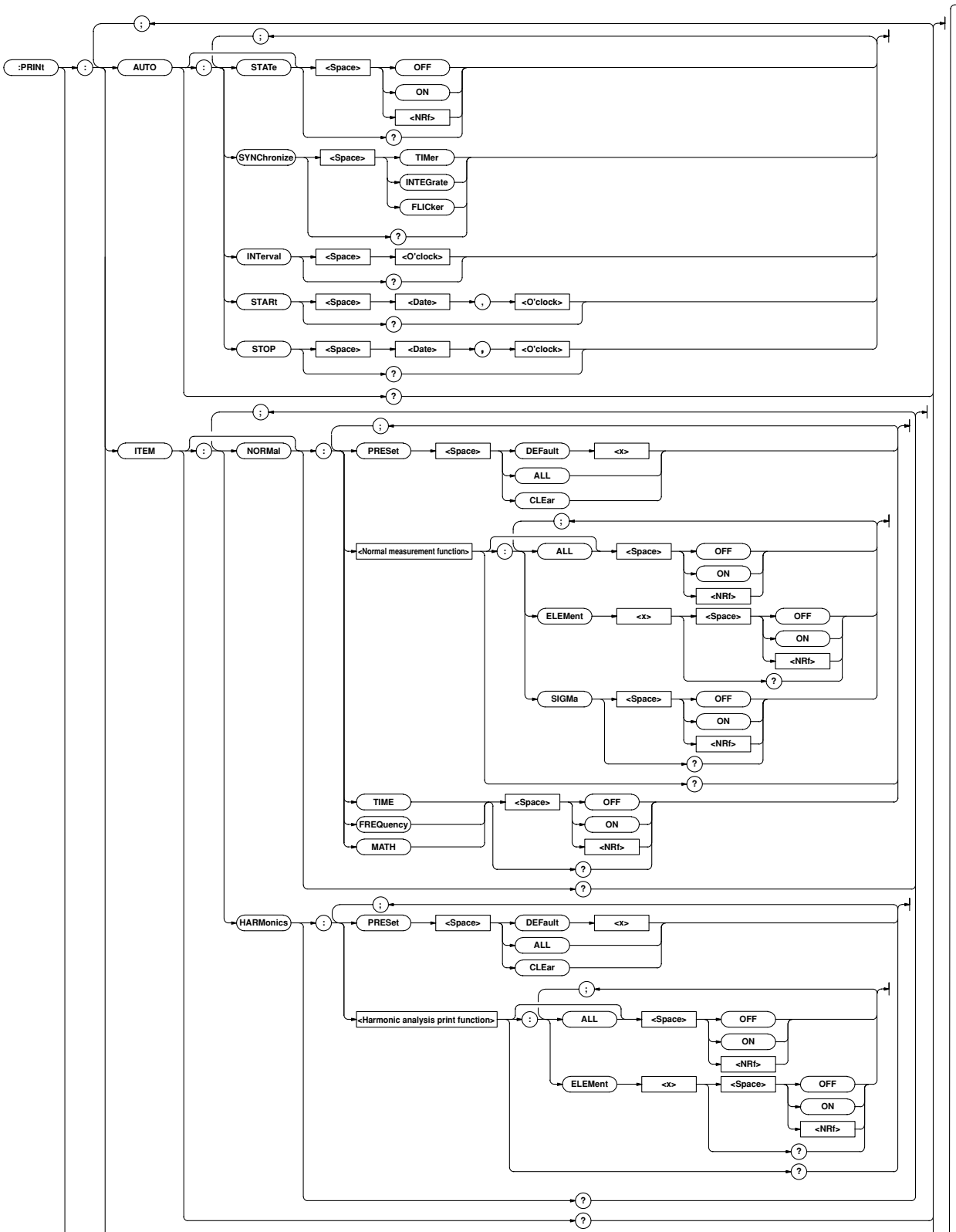



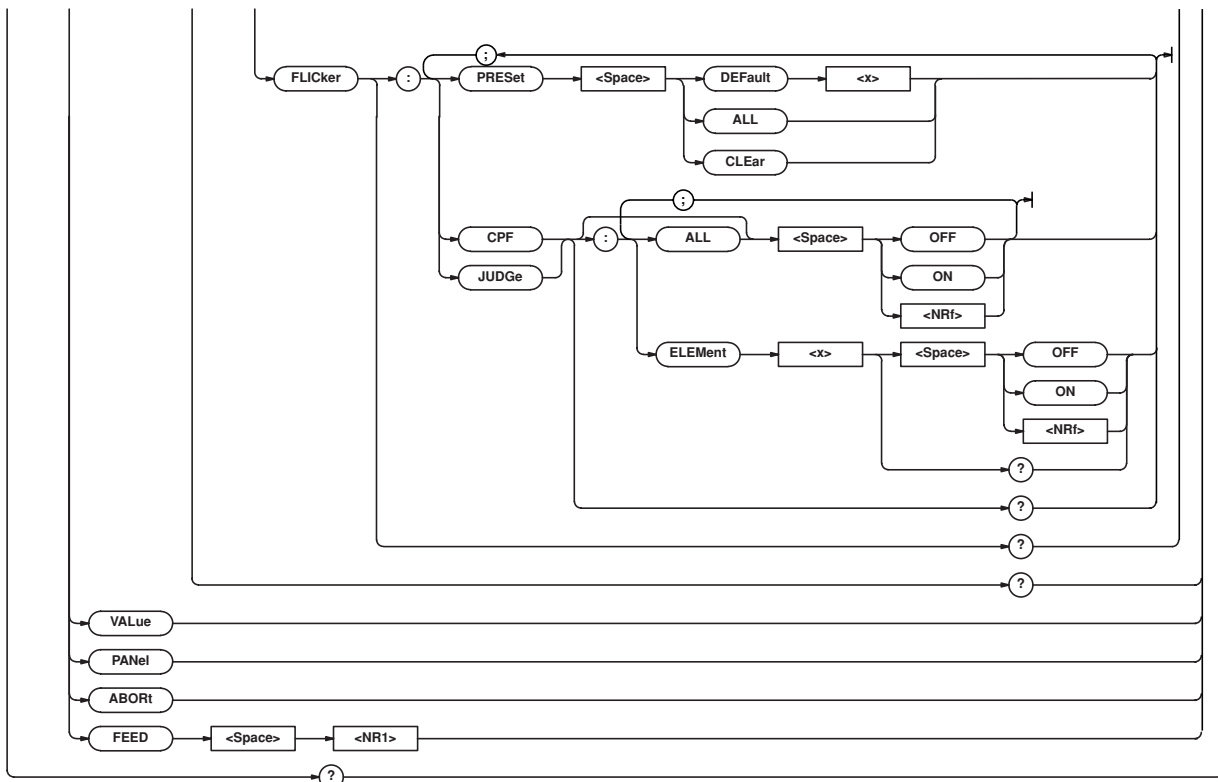

**PRINT?**

**Function** Queries all the current built-in printer settings.

**Syntax** PRINT?

**Example** PRINT? → (Response to PRINT:AUTO?);  
(Response to PRINT:ITEM?)

**PRINT:ABORt**

**Function** Stops printing.

**Syntax** PRINT:ABORt

**Example** PRINT:ABORt

**PRINT:AUTO?**

**Function** Queries all the current auto print mode settings.

**Syntax** PRINT:AUTO?

**Example** PRINT:AUTO? → :PRINT:AUTO:STATE  
0;SYNCHRONIZE TIMER;INTERVAL 0,1,0;START  
96,4,1,8,30,50;STOP 96,4,1,12,5,30

**PRINT:AUTO:INTERval**

**Function** Sets print interval for auto print mode/queries the current setting.

**Syntax** PRINT:AUTO:INTERval {<O'clock>}  
PRINT:AUTO:INTERval?  
{<O'clock>}={<NRf>,<NRf>[,<NRf>]|  
<Character string>}  
{<NRf>,<NRf>[,<NRf>]}=0,0,10,99,59,59  
{<Character string>}="HH:MM[:SS]"  
HHH: Hour MM: Miniute SS: Second

**Example** PRINT:AUTO:INTERVAL 0,1,0  
PRINT:AUTO:INTERVAL "0:1:0"  
PRINT:AUTO:INTERVAL? → :PRINT:AUTO:  
INTERVAL 0,1,0

**Description** If second (SS) is not set, the print interval will be 0 second.

**PRINT:AUTO:START**

**Function** Sets start time for auto print mode/queries the current setting.

**Syntax** PRINT:AUTO:START {<Date>,<O'clock>}  
PRINT:AUTO:START?  
<Date>={<NRf>,<NRf>,<NRf>|<Character string>}  
<O'clock>={<NRf>,<NRf>[,<NRf>]|  
<Character string>}

**Example** PRINT:AUTO:START 96,4,1,8,30,50  
PRINT:AUTO:START "1996/04/01","08:30:50"  
PRINT:AUTO:START → :PRINT:AUTO:START  
96,4,1,8,30,50

**Description** For <Date> and <O'clock> data, refer to Section 2.3.16, "SYSTEM Group".

**PRINT:AUTO[:STATE]**

**Function** Turns auto print mode ON or OFF/queries the current setting.

**Syntax** PRINT:AUTO[:STATE] {<Boolean>}  
PRINT:AUTO:STATE?

**Example** PRINT:AUTO:STATE OFF  
PRINT:AUTO:STATE? → :PRINT:AUTO:STATE 0

**PRINT:AUTO:STOP**

**Function** Sets stop time for auto print mode/queries the current setting.

**Syntax** PRINT:AUTO:STOP {<Date>,<O'clock>}  
PRINT:AUTO:STOP?  
<Date>={<NRf>,<NRf>,<NRf>|<Character string>}  
<O'clock>={<NRf>,<NRf>[,<NRf>]|  
<Character string>}

**Example** PRINT:AUTO:STOP 1996,04,01,12,05,30  
PRINT:AUTO:STOP "96/4/1","12:5:30"  
PRINT:AUTO:STOP → :PRINT:AUTO:STOP  
96,4,1,12,5,30

**Description** For <Date> and <O'clock> data, refer to Section 2.3.16, "SYSTEM Group".

**PRINT:AUTO:SYNChronize**

**Function** Sets print synchronization method for auto print mode/queries the current setting.

**Syntax** PRINT:AUTO:SYNChronize {TIMER|INTEGrate|FLICKer}

PRINT:AUTO:SYNChronize?

**Example** PRINT:AUTO:SYNCHRONIZE TIMER  
PRINT:AUTO:SYNCHRONIZE?→:PRINT:AUTO:  
SYNCHRONIZE TIMER

**Description** Selectable print synchronization methods are given below.

TIMER : Start/stop time synchronization  
INTEGrate : Integration time synchronization  
FLICKer : Flicker measurement synchronization

**PRINT:FEED**

**Function** Feeds print paper.

**Syntax** PRINT:FEED {<NR1>}  
{<NR1>}=1 to 20

**Example** PRINT:FEED 5

**PRINT:ITEM?**

**Function** Queries all the printer settings for measured/computed data.

**Syntax** PRINT:ITEM?

**Example** PRINT:ITEM?→(Response to PRINT:ITEM: NORMAL?);  
(Response to PRINT:ITEM: HARMONICS?); (Response  
to PRINT:ITEM: FLICKer?)

**PRINT:ITEM:FLICKer?**

**Function** Queries all the printer output items for flicker measurement.

**Syntax** PRINT:ITEM:FLICKer?

**Example** PRINT:ITEM:FLICKER?→:PRINT:ITEM:  
FLICKER:CPF:ELEMENT1 1;ELEMENT2 0;ELEMENT3  
0;:PRINT:ITEM:FLICKER:JUDGE:ELEMENT1  
1;ELEMENT2 0;ELEMENT3 0

**PRINT:ITEM:FLICKer:{CPF|JUDGE}?**

**Function** Queries all the printer output items for CPF graph or flicker meter judgment result table.

**Syntax** PRINT:ITEM:FLICKer:CPF?

**Example** PRINT:ITEM:FLICKER:CPF?→:PRINT:ITEM:  
FLICKER:CPF:ELEMENT1 1;ELEMENT2 0;ELEMENT3  
0

**PRINT:ITEM:FLICKer:{CPF|JUDGE}[:ALL]**

**Function** Turns printer output of CPF graph or flicker meter judgment result table ON or OFF for all the valid elements at once.

**Syntax** PRINT:ITEM:FLICKer:CPF[:ALL] {<Boolean>}

**Example** PRINT:ITEM:FLICKER:CPF:ALL ON

**PRINT:ITEM:FLICKer:{CPF|JUDGE}:ELEMENT<x>**

**Function** Turns printer output of CPF graph or flicker meter judgment result table ON or OFF for the specified element/queries the current setting.

**Syntax** PRINT:ITEM:FLICKer:CPF:ELEMENT<x>  
{<Boolean>}

PRINT:ITEM:FLICKer:CPF:ELEMENT<x>?

<x>= 1, 3(3-phase 3-wire model)  
1 to 3(3-phase 4-wire model)

**Example** PRINT:ITEM:FLICKER:CPF:ELEMENT1 ON

PRINT:ITEM:FLICKER:CPF:ELEMENT1?→:PRINT:  
ITEM:FLICKER:CPF:ELEMENT1 1

**PRINT:ITEM:FLICKer:PRESet**

**Function** Sets the printer output items for flicker measurement mode to the specified default setting at once.

**Syntax** PRINT:ITEM:FLICKer:PRESet {DEFault<1-  
2>|ALL|CLEAr}

**Example** PRINT:ITEM:FLICKER:PRESET DEFAULT1

**Description** • For a detailed description of default setting, refer to 11.2  
"Setting Printer Output Functions".

**PRINT:ITEM:HARMONICS?**

**Function** Queries all the print output items for harmonic analysis mode.

**Syntax** PRINT:ITEM:HARMONICS?

**Example** PRINT:ITEM:HARMONICS?→:PRINT:ITEM:HARMONICS:V:ELEMENT1 1;  
ELEMENT2 1;ELEMENT3 1;:PRINT:ITEM:HARMONICS:A:ELEMENT1 1;  
ELEMENT2 1;ELEMENT3 1;:PRINT:ITEM:HARMONICS:W:ELEMENT1 1;  
ELEMENT2 1;ELEMENT3 1;:PRINT:ITEM:HARMONICS:DEG:ELEMENT1 0;  
ELEMENT2 0;ELEMENT3 0;:PRINT:ITEM:HARMONICS:GV:ELEMENT1 0;  
ELEMENT2 0;ELEMENT3 0;:PRINT:ITEM:HARMONICS:GA:ELEMENT1 0;  
ELEMENT2 0;ELEMENT3 0;:PRINT:ITEM:HARMONICS:GW:ELEMENT1 0;  
ELEMENT2 0;ELEMENT3 0;:PRINT:ITEM:HARMONICS:GVD:ELEMENT1 0;  
ELEMENT2 0;ELEMENT3 0;:PRINT:ITEM:HARMONICS:GAD:ELEMENT1 0;  
ELEMENT2 0;ELEMENT3 0;:PRINT:ITEM:HARMONICS:CGV:ELEMENT1 0;  
ELEMENT2 0;ELEMENT3 0;:PRINT:ITEM:HARMONICS:CGA:ELEMENT1 0;  
ELEMENT2 0;ELEMENT3 0;:PRINT:ITEM:HARMONICS:CGW:ELEMENT1 0;  
ELEMENT2 0;ELEMENT3 0

**PRINT:ITEM:HARMonics:<Harmonic analysis function>?**

**Function** Queries all the printer output settings for the specified harmonic analysis function.

**Syntax** PRINT:ITEM:HARMonics:<Harmonic analysis function>?

**Example** PRINT:ITEM:HARMONICS:V?→:PRINT:ITEM:HARMONICS:V:ELEMENT1 1;ELEMENT2 1;ELEMENT3 1

**Description** Selectable functions are given below.

- V : Analysis voltage value and relative harmonic content are printed in numeric.
  - A : Analysis current value and relative harmonic content are printed in numeric.
  - W : Analysis active power value and relative harmonic content are printed in numeric.
  - DEG: Phase angle of voltage of each harmonic from 2nd to n\*th in relation to voltage of the 1st and phase angle of voltage of each harmonic from 2nd to n\*th in relation to current of the 1st are printed in numeric.
  - GV : Analysis voltage value is printed in graph.
  - GA : Analysis current value is printed in graph.
  - GW : Analysis active power value is printed in graph.
  - GVD: Phase angle of voltage of each harmonic from 2nd to n\*th in relation to voltage of the 1st is printed in graph.
  - GAD: Phase angle of current of each harmonic from 2nd to n\*th in relation to current of the 1st is printed in graph.
  - CGV: Relative harmonic content of voltage is printed in graph.
  - CGA: Relative harmonic content of current is printed in graph.
  - CGW: Relative harmonic content of active power is printed in graph.
- \* "n" is the upper limit of the harmonic order.

**PRINT:ITEM:HARMonics:<Harmonic analysis function>[:ALL]**

**Function** Turns printer output for the specified harmonic analysis function ON or OFF for all the effective elements at once.

**Syntax** PRINT:ITEM:HARMonics:<Harmonic analysis function>[:ALL] {<Boolean>}

**Example** PRINT:ITEM:HARMONICS:V:ALL ON

**PRINT:ITEM:HARMonics:<Harmonic analysis function>:ELEMent<x>**

**Function** Turns printer output for the specified harmonic analysis function ON or OFF for the specified element/queries the current setting.

**Syntax** PRINT:ITEM:HARMonics:<Harmonic analysis function>:ELEMent<x> {<Boolean>}  
 PRINT:ITEM:HARMonics:<Harmonic analysis function>:ELEMent<x>?  
 <x>=1,3(3-phase 3-wire model)  
 =1 to 3(3-phase 4-wire model)

**Example** PRINT:ITEM:HARMONICS:V:ELEMENT1 ON  
 PRINT:ITEM:HARMONICS:V:ELEMENT1?  
 →:PRINT:ITEM:HARMONICS:V:ELEMENT1 1

**PRINT:ITEM:HARMonics:PRESet**

**Function** Sets printer output items for harmonic analysis mode to the specified default setting at once.

**Syntax** PRINT:ITEM:HARMonics:PRESet {DEFAULT<1-2>|ALL|CLEAr}

**Example** PRINT:ITEM:HARMONICS:PRESET DEFAULT1

**Description** For a description of global setting, refer to Section 11.2, "Setting Printer Output Functions".

**PRINT:ITEM:NORMal?**

**Function** Queries all the printer output items for normal measurement mode.

**Syntax** PRINT:ITEM:NORMal?

**Example** PRINT:ITEM:NORMal?→:PRINT:ITEM:NORMal:V:ELEMENT1 1;ELEMENT2 1;ELEMENT3 1;SIGMA 1;:PRINT:ITEM:NORMal:A:ELEMENT1 1;ELEMENT2 1;ELEMENT3 1; SIGMA 1;:PRINT:ITEM:NORMal:W:ELEMENT1 1;ELEMENT2 1; ELEMENT3 1;SIGMA 1;:PRINT:ITEM:NORMal:VA:ELEMENT1 0; ELEMENT2 0;ELEMENT3 0;SIGMA 0;: PRINT:ITEM:NORMal:VAR:ELEMENT1 0;ELEMENT2 0;ELEMENT3 0;SIGMA 0;:PRINT:ITEM:NORMal:PF:ELEMENT1 0;ELEMENT2 0;ELEMENT3 0;SIGMA 0;:PRINT:ITEM:NORMal:DEG:ELEMENT1 0; ELEMENT2 0;ELEMENT3 0;SIGMA 0;: PRINT:ITEM:NORMal:VPK:ELEMENT1 0;ELEMENT2 0;ELEMENT3 0; :PRINT:ITEM:NORMal:APK:ELEMENT1 0;ELEMENT2 0; ELEMENT3 0;:PRINT:ITEM:NORMal:WH:ELEMENT1 0;ELEMENT2 0;ELEMENT3 0;SIGMA 0;: PRINT:ITEM:NORMal:WHP:ELEMENT1 0;ELEMENT2 0;ELEMENT3 0; SIGMA 0;:PRINT:ITEM:NORMal:WHM:ELEMENT1 0;ELEMENT2 0; ELEMENT3 0;SIGMA 0;:PRINT:ITEM:NORMal:AH:ELEMENT1 0; ELEMENT2 0;ELEMENT3 0;SIGMA 0;: PRINT:ITEM:NORMal:AHP:ELEMENT1 0;ELEMENT2 0;ELEMENT3 0; SIGMA 0;:PRINT:ITEM:NORMal:AHM:ELEMENT1 0;ELEMENT2 0; ELEMENT3 0;SIGMA 0;:PRINT:ITEM:NORMal:TIME 0;FREQUENCY 1; MATH 0

**PRINT:ITEM[:NORMal]:<Normal measurement function>?**

**Function** Queries all the printer output settings for the specified normal measurement function.

**Syntax** PRINT:ITEM[:NORMal]:<Normal measurement function>?  
<Normal measurement function>={V|A|W|VA|VAR|PF|DEG|VPK|APK|WH|WHP|WHM|AH|AHP|AHM}

**Example** PRINT:ITEM:NORMAL:V?→:PRINT:ITEM:NORMAL:V:ELEMENT1 1;ELEMENT2 1;ELEMENT3 1;SIGMA 1

**PRINT:ITEM[:NORMal]:<Normal measurement function >[:ALL]**

**Function** Turns printer output for the specified normal measurement function ON or OFF for all the effective elements and  $\Sigma$  at once.

**Syntax** PRINT:ITEM[:NORMal]:<Normal measurement function>[:ALL] {<Boolean>}

**Example** PRINT:ITEM:NORMAL:V:ALL ON

**PRINT:ITEM[:NORMal]:<Normal measurement function>:ELEMENT<x>**

**Function** Turns printer output for the specified normal measurement function ON or OFF for the specified element/queries the current setting.

**Syntax** PRINT:ITEM[:NORMal]:<Normal measurement function>:ELEMENT<x> {<Boolean>}  
PRINT:ITEM[:NORMal]:<Normal measurement function>:ELEMENT<x>?  
<x>=1, 3(3-phase 3-wire model)  
=1 to 3(3-phase 4-wire model)

**Example** PRINT:ITEM:NORMAL:V:ELEMENT1 ON  
PRINT:ITEM:NORMAL:V:ELEMENT1?→:PRINT:ITEM:NORMAL:V:ELEMENT1 1

**PRINT:ITEM[:NORMal]:<Normal measurement function>:SIGMA**

**Function** Turns printer output of  $\Sigma$  data ON or OFF for the specified harmonic analysis function/queries the current setting.

**Syntax** PRINT:ITEM[:NORMal]:<Normal measurement function>:SIGMA {<Boolean>}  
PRINT:ITEM[:NORMal]:<Normal measurement function>:SIGMA?

**Example** PRINT:ITEM:NORMAL:V:SIGMA ON  
PRINT:ITEM:NORMAL:V:SIGMA?→:PRINT:ITEM:NORMAL:V:SIGMA 1

**Description** It is not possible to set VPK and APK normal measurement functions using this command.

**PRINT:ITEM[:NORMal]:{TIME|FREQUENCY|MATH}**

**Function** Turns communication output ON or OFF for the elapsed time of integration, frequency and computed data/queries the current setting.

**Syntax** PRINT:ITEM[:NORMal]:{TIME|FREQUENCY|MATH}{<Boolean>}PRINT:ITEM[:NORMal]:{TIME|FREQUENCY|MATH}?

**Example** PRINT:ITEM:NORMAL:FREQUENCY ON  
PRINT:ITEM:NORMAL:FREQUENCY?→:PRINT:ITEM:NORMAL:FREQUENCY 1

**PRINT:ITEM[:NORMal]:PRESet**

**Function** Sets printer output items for normal measurement mode to the preset settings at once.

**Syntax** PRINT:ITEM[:NORMal]:PRESet {DEFAULT<1-2>|ALL|CLEAR}

**Example** PRINT:ITEM:NORMAL:PRESET DEFAULT1

**Description** For a description of global setting, refer to Section 11.2, "Setting Printer Output Functions (Optional)".

**PRINT:PANel**

**Function** Prints set-up information.

**Syntax** PRINT:PANel

**Example** PRINT:PANEL

**PRINT:VALue**

**Function** Prints all the measured/computed data for the items which are set to ON using "PRINT:ITEM" commands ("PRINT:ITEM:HARMONICS" through "PRINT:ITEM[:NORMal]:PRESet").

**Syntax** PRINT:VALue

**Example** PRINT:VALUE

### 2.3.12 RECall Group

The commands in the RECall group are used to recall set-up information. This allows you to make the same settings and inquiries which can be made using the MISC key ("RECALL" menu) on the front panel.

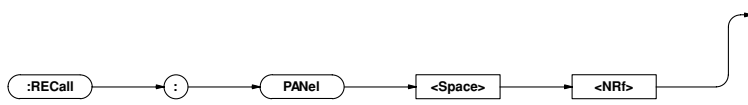

#### RECall: PANel

**Function** Recalls set-up information from the specified file of the internal memory.

**Syntax** RECALL: PANel {<NRf>}  
 {<NRf>}=1 to 4 :File no.

**Example** RECALL: PANel 1

### 2.3.13 SAMPlE Group

The commands in the SAMPlE group are used to make settings relating to and to inquire about sampling. This allows you to make the same settings and inquiries which can be made using the HOLD and RATE keys on the front panel.

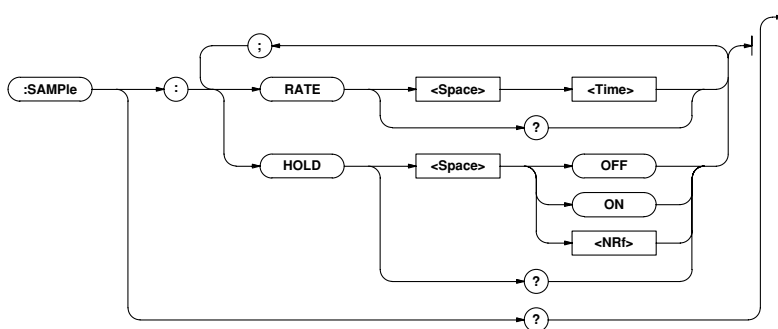

#### SAMPlE?

**Function** Queries all the current sampling settings.

**Syntax** SAMPlE?

**Example** SAMPLE? -> :SAMPLE:RATE 0.500E+00;HOLD 0

#### SAMPlE:HOLD

**Function** Turns hold mode for output data (display, communication data) ON and ON/queries the current setting.

**Syntax** SAMPlE:HOLD {<Boolean>}  
 SAMPlE:HOLD?

**Example** SAMPLE:HOLD ON  
 SAMPLE:HOLD? -> :SAMPLE:HOLD 1

#### SAMPlE:RATE

**Function** Sets sample rate/queries the current setting.

**Syntax** SAMPlE:RATE {<Time>}  
 SAMPlE:RATE?  
 <Time>= 0.25 to 2.0sec(0.25,0.5,2.0sec)

**Example** SAMPLE:RATE 500MS  
 SAMPLE:RATE? -> :SAMPLE:RATE 0.500E+00

## 2.3.14 STATus Group

The commands in the STATus group are used to make settings relating to and to inquire about the communications status function. There is no front panel key for this function. For details of the status report, refer to Appendix 2.4.

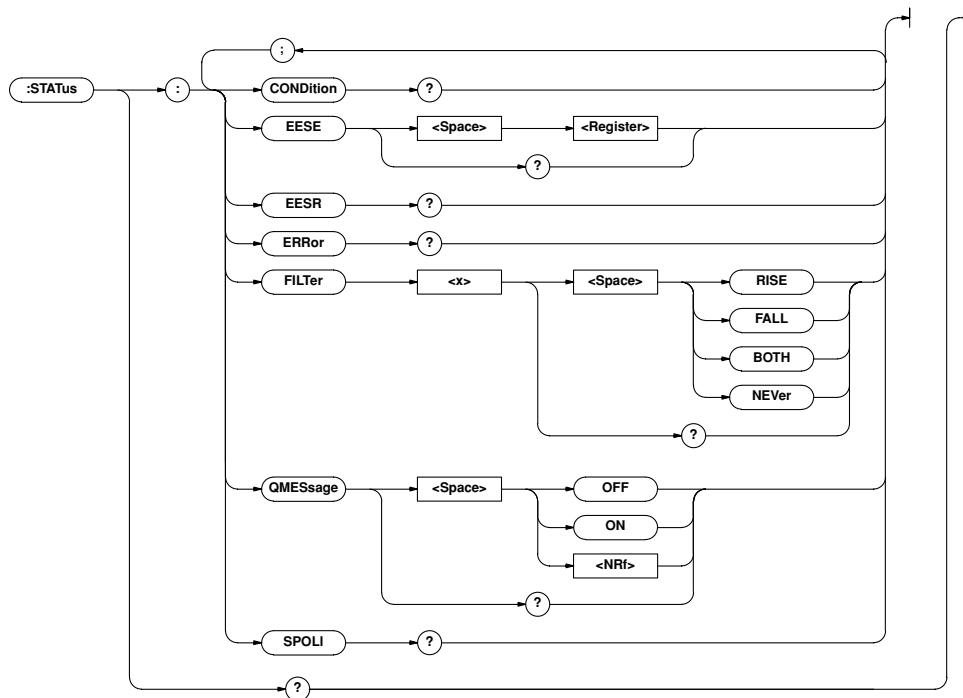

### STATus?

**Function** Queries all the settings relating to the communications status function.

**Syntax** STATus?

**Example** STATus? → : STATus : EESE 0 ; FILTER1 NEVER ; FILTER2 NEVER ; FILTER3 NEVER ; FILTER4 NEVER ; FILTER5 NEVER ; FILTER6 NEVER ; FILTER7 NEVER ; FILTER8 NEVER ; FILTER9 NEVER ; FILTER10 NEVER ; FILTER11 NEVER ; FILTER12 NEVER ; FILTER13 NEVER ; FILTER14 NEVER ; FILTER15 NEVER ; FILTER16 NEVER ; QMESSAGE 1

### STATus:CONDition?

**Function** Queries the contents of the condition register.

**Syntax** STATus:CONDition?

**Example** STATus:CONDition→16

**Description** For a description of the condition register, refer to Appendix 2.4, "Status Report".

### STATus:EESE

**Function** Sets the extended event enable register/queries the current setting.

**Syntax** STATus:EESE <Register>

STATus:EESE?

<Register>=0 to 65535

**Example** STATus:EESE 257

STATus:EESE?→:STATus:EESE 257

**Description** For a description of the extended event enable register, refer to Appendix 2.4, "Status Report".

### STATus:EESR?

**Function** Queries the contents of the extended event register and clears the register.

**Syntax** STATus:EESR?

**Example** STATus:EESR?→1

**Description** For a description of the extended event register, refer to Appendix 2.4, "Status Report".

### STATus:ERRor?

**Function** Queries the code and the message (at the beginning of the error queue) of the error which has occurred.

**Syntax** STATus:ERRor?

**Example** STATus:ERRor?→113, "Undefined header"

**STATus:FILTER<x>**

**Function** Queries all the settings relating to the specified transit filter/  
queries the current settings.

**Syntax** STATus:FILTER<x>  
{RISE|FALL|BOTH|NEVER}  
STATus:FILTER<x>?  
<x>=1~16

**Example** STATus:FILTER2 RISE  
STATus:FILTER2?→:STATus:FILTER2 RISE

**Description** For a description of the transit filter, refer to Appendix 2.4,  
"Status Report".

**STATus:QMESsage**

**Function** Selects whether or not to add the message contents to a  
response to "STATus:ERRor?"/queries the current setting.

**Syntax** STATus:QMESsage {<Boolean>}  
STATus:QMESsage?

**Example** STATus:QMESsage OFF  
STATus:QMESsage?→:STATus:QMESsage 0

**STATus:SPOLL?(Serial Poll)**

**Function** Executes serial poll.

**Syntax** STATus:SPOLL?

**Example** STATus:SPOLL?→:STATus:SPOLL 0

**Description** This command is available only for the RS-232-C interface.

**2.3.15 STORE Group**

The commands in the STORE group are used to make settings relating to and to inquire about storage of set-up information. This allows you to make the same settings and inquiries which can be made using the MISC key ("StoreE" menu) on the front panel.

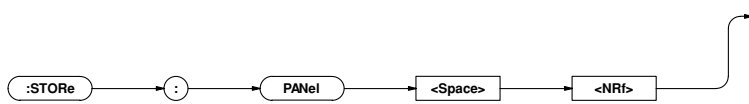

**STORe:PANel**

**Function** Stores set-up information in the internal memory

**Syntax** STORe:PANel {<NRf>}  
{<NRf>}=1 to 4 :File no.

**Example** STORe:PANel 1

## 2.3.16 SYSTem Group

The commands in the SYSTem group are used to make settings relating to and to inquire about system (internal clock). This allows you to make the same settings and inquiries which you can make using the MISC key ("dAtE" menu) on the front panel.

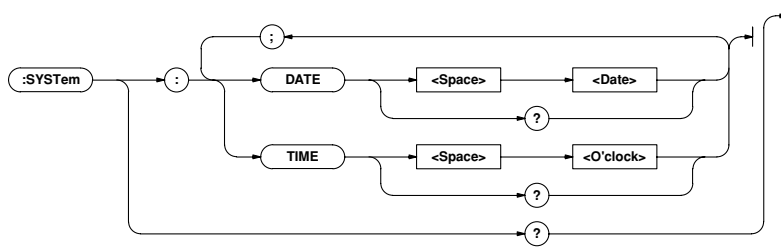

### SYSTem?

**Function** Queries all the system (internal clock) settings.

**Syntax** SYSTem?

**Example** SYSTem?→:SYSTem:DATE 96,4,1;TIME 17,15,0

### SYSTem:DATE

**Function** Sets the date/queries the current setting.

**Syntax** SYSTem:DATE {<Date>}

SYSTem:DATE?

{<Date>}={<NRf>,<NRf>,<NRf>|<Character string>}

{<NRf>,<NRf>,<NRf>}=[19]96,1,1,[20]95,12,31  
 {<Character string>}="[YY]YY/MM/DD"  
 [YY]YY: Year MM: Month DD: Day

**Example** SYSTem:DATE 96,4,1

SYSTem:DATE 1996,04,01

SYSTem:DATE "96/04/01"

SYSTem:DATE "1996/4/1"

SYSTem:DATE?→:SYSTem:DATE 96,4,1

### SYSTem:TIME

**Function** Sets the time/queries the current setting.

**Syntax** SYSTem:TIME {<O'clock>}

SYSTem:TIME?

{<O'clock>}={<NRf>,<NRf>[,<NRf>]|<Character string>}

{<NRf>,<NRf>[,<NRf>]}=0,0,0,23,59,59  
 {<Character string>}="HH:MM[:SS]"

HH: Hour MM: Minute SS: Second

**Example** SYSTem:TIME 17,15,0

SYSTem:TIME 17,15

SYSTem:TIME "17:15:0"

SYSTem:TIME "17:15"

SYSTem:TIME?→:SYSTem:TIME 17,15,0

**Description** If second (SS) is not set, it will be 0 second.



### 2.3.17 Common Command Group

The commands in the common command group are independent of the instrument's functions, and are specified in IEEE 488.2-1987. There is no front panel key that corresponds to this group.

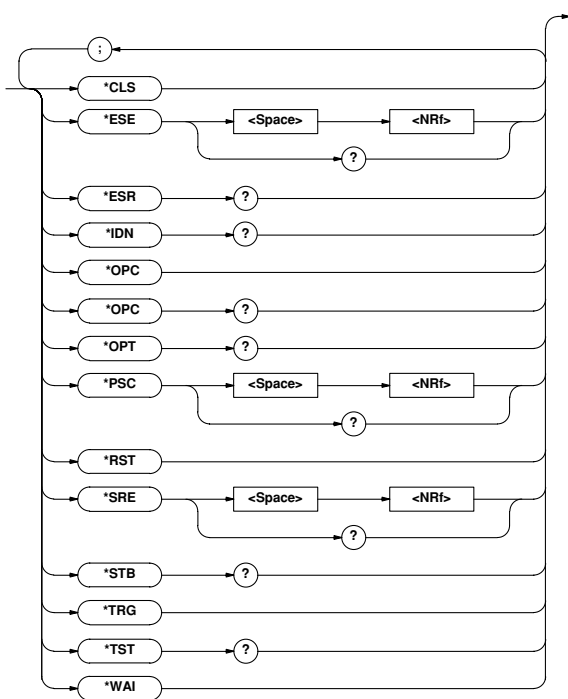

#### \*CLS

**Function** Clears the standard event register, extended event register and error queue.

**Syntax** \*CLS

**Example** \*CLS

**Description**

- The output queue will also be cleared if a "\*CLS" command is appended after the program message terminator.
- For details of the registers and queues, refer to Appendix 2.4.

#### \*ESE

**Function** Sets the value for the standard event enable register/queries the current setting.

**Syntax** \*ESE {<NRf>}  
 \*ESE?  
 {<NRf>}=0 to 255

**Example** \*ESE 251  
 \*ESE?→251

**Description**

- <NRf> is the sum of the bits expressed as a decimal number.
- For example, if "\*ESE 251" is set, the standard event enable register will be set to "111111011". This means that bit 2 of the standard event register is disabled so that bit 5 (ESB) of the status byte register will not be set to "1", even if a query error occurs.
- Default is "0", i.e. all bits are disabled.
- The standard event enable register will not be cleared, even if a query is made using "\*ESE?".
- For details of the standard event enable register, refer to App 2-50.

#### \*ESR?

**Function** Queries the value of the standard event register and clears it at the same time.

**Syntax** \*ESR?

**Example** \*ESR?→32

**Description**

- The sum of the bits is returned as a decimal value.
- It is possible to ascertain the type of event which has occurred, while SRQ is occurring.
- For example, if "32" is returned, this means that the standard event register is "00100000", i.e. the SRQ has occurred due to a command syntax error.
- If a query is made using "\*ESR?", the standard event register will be cleared.
- For details of the standard event register, refer to page App 2-50.

#### \*IDN?

**Function** Queries the instrument model.

**Syntax** \*IDN?

**Example** \*IDN?→YOKOGAWA,253103,0,F1.01

**Description** A reply consists of the following sequence: <Manufacturer>, <Model>, <Serial No.> and <Firmware version>.

#### \*OPC

**Function** This command sets bit 0 of the standard event register to "1" when execution of the specified overlap command has been completed. This command will be ignored since overlap commands are not supported by this instrument.

**Syntax** \*OPC

**\*OPC?**

**Function** "1" will be returned if execution of the designated overlap command has been completed. "1" will always be returned since overlap commands are not supported by this instrument.

**Syntax** \*OPC?

**\*OPT?**

**Function** Queries installed options.

**Syntax** \*OPT?

**Example** \*OPT?→DA,PRINTER,HARMONICS,FLICKER

**Description** • "None" will be attached to the reply if no options are installed.  
 • "\*OPT?" must always be the last query in a program message. If there is another query after "\*OPT?", an error will occur.

**\*PSC**

**Function** Selects whether or not to clear the following registers when power is turned ON/queries the current setting. However, they cannot be cleared if the parameter is "0".

- Standard event enable register
- Extended event enable register
- Transit filter

**Syntax** \*PSC {<NRf>}

\*PSC?

{<NRf>}= 0 (does not clear the registers) value other than 0 (clears the registers)

**Example** \*PSC 1

\*PSC?→1

**Description** For details of each register, refer to Appendix 2.4.

**\*RST**

**Function** Resets (initialize) the current settings.

**Syntax** \*RST

**Example** \*RST

**Description** For a detailed description, refer to Section 13.1, "Storing, Recalling and Initializing Set-up Information". All the set-up information except for those relating to communication are reset.

**\*SRE**

**Function** Sets the value of the service request enable register/queries the current setting.

**Syntax** \*SRE {<NRf>}

\*SRE?

{<NRf>}=0 to 255

**Example** \*SRE 239

\*SRE?→175(since the setting of bit 6 (MSS) is ignored)

**Description** • <NRf> is the sum of the bits expressed as a decimal number.

- For example, if "\*SRE 239" is set, the service request enable register will be set to "11101111". This means that bit 4 of the service request enable register is disabled, so that bit 4 (MAV) of the status byte register will not be set to "1", even if the output queue is not empty.
- However, bit 6 (MSS) of the status byte register is the MSS bit, so it will be ignored.
- Default is "0", i.e. all bits are disabled.
- The service request enable register will not be cleared, even if a query is made using "\*SRE?".

- For details of the service request enable register, refer to page App 2-56.

**\*STB?**

**Function** Queries the value of the status byte register.

**Syntax** \*STB?

**Example** \*STB?→4

- Description** • The sum of the bits expressed as a decimal value is returned.
- Bit 6 is MSS not RQS, since the register is read without serial polling.
  - For example, if "4" is returned, the status byte register is set to "00000100", i.e. the error queue is not empty (an error has occurred).
  - The status byte register will not be cleared, even if a query is made using "\*STB?".
  - For details of the status byte register, refer to page App 2-56.

**\*TRG**

**Function** Carries out the same function as when the TRIG key (SHIFT + HOLD) is pressed.

**Syntax** \*TRG

**Description** The GET (Group Execute Trigger) multi-line message also carried out the same function as this command.

**\*TST?**

**Function** Executes a self-test and queries the test result. All internal memories boards are tested.

**Syntax** \*TST?

**Example** \*TST?→0

**Description** • "0" will be returned if the self test result is satisfactory. "1" will be returned if an abnormality is detected during the test.

**\*WAI**

**Function** Waits for the command following "\*WAI" until execution of the designated overlap command has been completed. This command will be ignored since overlap commands are not supported by this instrument.

**Syntax** \*WAI

## Appendix 2.4 Status Report

### 2.4.1 Status Report

#### Overview of the Status Report

The figure below shows the status report which is read by a serial poll. This is an extended version of the one specified in IEEE 488.2-1987.

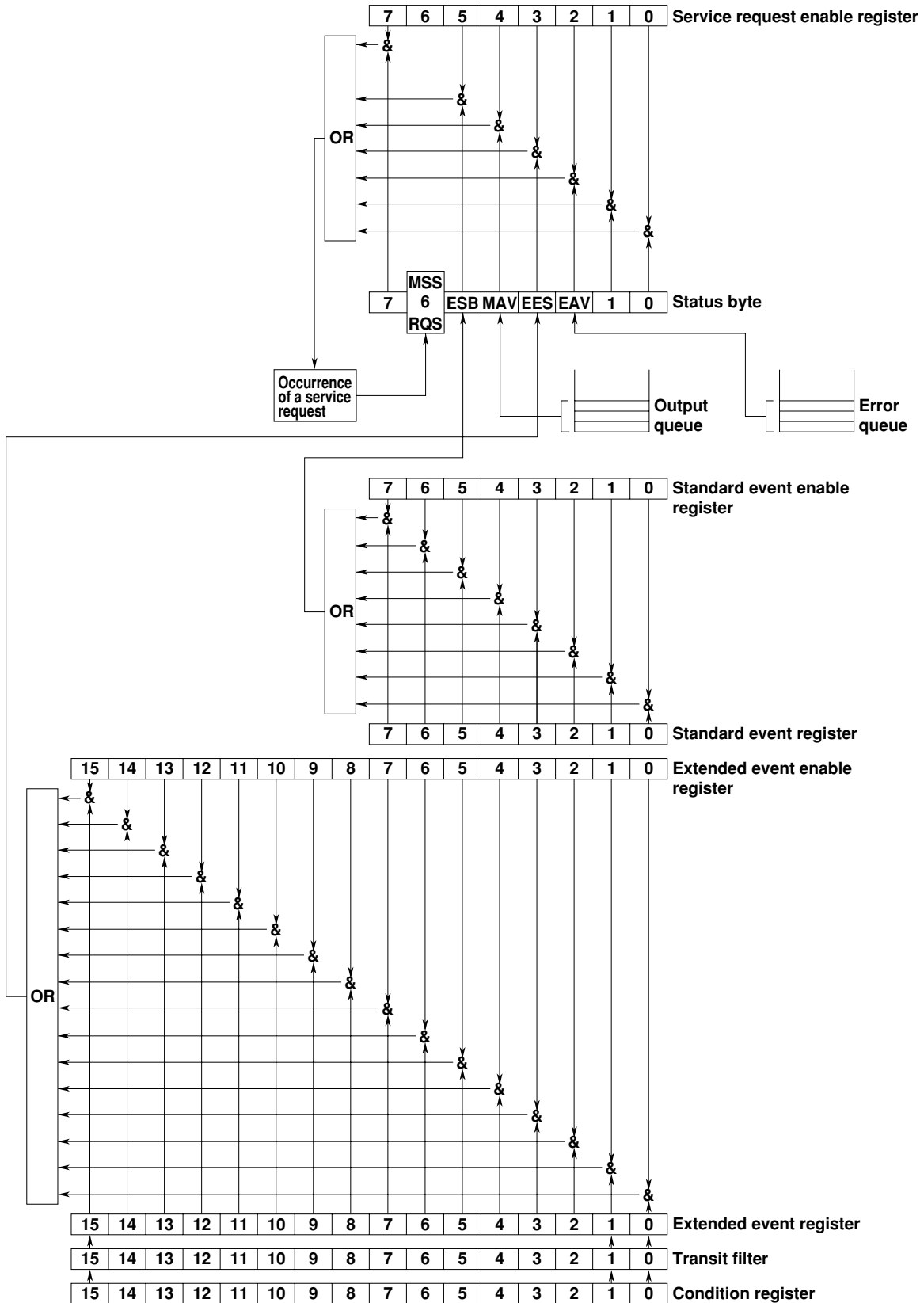

## Overview of Registers and Queues

| Name                            | Function                                      | Writing              | Reading                         |
|---------------------------------|---|----------------------|---------------------------------|
| Status byte                     | —   | —                    | Serial poll<br>RQS), *STB?(MSS) |
| Service request enable register | Masks status byte.                            | *SRE                 | *SRE?                           |
| Standard event register         | Event in the instrument                       | —                    | *ESR?                           |
| Standard event enable register  | Masks standard event register.                | *ESE                 | *ESE?                           |
| Extended event register         | Event in the instrument                       | —                    | STATUS:EESR?                    |
| Extended event enable register  | Masks extended event register.                | STATUS:EESE          | STATUS:EESE?                    |
| Condition register              | Current instrument status                     | —                    | STATUS:CONDition?               |
| Transit filter                  | Extended event occurrence register conditions | STATUS:FILTer<br><x> | STATUS:FILTer<x>?               |
| Output queue                    | Stores response message to a query.           | All queries          |                                 |
| Error queue                     | Stores error Nos. and messages.               | —                    | STATUS:ERRor?                   |

### Registers and Queues which Affect the Status Byte

Registers which affect each bit of the status byte are shown below

|                         |  |
|-------------------------|--|
| Standard event register | : Sets bit 5 (ESB) of status byte to "1" or "0". |
| Output queue            | : Sets bit 4 (MAV) of status byte to "1" or "0". |
| Extended event register | : Sets bit 3 (EES) of status byte to "1" or "0". |
| Error queue             | : Sets bit 2 (EAV) of status byte to "1" or "0". |

### Enable Registers

Registers which mask a bit so that the bit does not affect the status byte, even if the bit is set to "1", are shown below.

|                         |  |
|-------------------------|--|
| Status byte             | : Masks bits using the service event enable register.  |
| Extended event register | : Masks bits using the extended event enable register. |

### Writing/Reading from Registers

The \*ESE command is used to set bits in the standard event enable register to "1" or "0", and the \*ESE? query is used to check whether bits in that register are set to "1" or "0". For details of these commands, refer to Appendix 2.3.

## 2.4.2 Status Byte

### Overview of Status Byte



#### • Bits 0, 1 and 7

Not used (always "0")

#### • Bit 2 EAV (Error Available)

Set to "1" when the error queue is not empty, i.e. when an error occurs. For details, refer to page App 2-60.

#### • Bit 3 EES (Extended Event Summary Bit)

Set to "1" when a logical AND of the extended event register and the corresponding enable register is "1", i.e. when an event takes place in the instrument. Refer to page App 2-59.

#### • Bit 4 MAV (Message Available)

Set to "1" when the output queue is not empty, i.e. when there is data which is to be output when a query is made. Refer to page App 2-60.

#### • Bit 5 ESB (Event Summary Bit)

Set to "1" when a logical AND of the standard event register and the corresponding enable register is "1", i.e. when an event takes place in the instrument. Refer to page App 2-58.

#### • Bit 6 RQS (Request Service)/MSS (Master Status Summary)

Set to "1" when a logical AND of the status byte (except for bit 6) and the service request enable register is not "0", i.e. when the instrument is requesting service from the controller. RQS is set to "1" when MSS changes from "0" to "1", and is cleared when a serial poll is performed or when MSS changes to "0".

### Bit Masking

To mask a bit in the status byte so that it does not cause an SRQ, set the corresponding bit of the service request enable register to "0". For example, to mask bit 2 (EAV) so that no service will be requested, even if an error occurs, set bit 2 of the service request enable register to "0". This can be done using the \*SRE command. To query whether each bit of the service request enable register is "1" or "0", use \*SRE?. For details of the \*SRE command, refer to Appendix 2.3.

### Operation of the Status Byte

A service request is issued when bit 6 of the status byte becomes "1". Bit 6 becomes "1" when any of the other bits becomes "1" (or when the corresponding bit in the service request enable register becomes "1"). For example, if an event takes place and the logical OR of each bit of the standard event register and the corresponding bit in the enable register is "1", bit 5 (ESB) will be set to "1". In this case, if bit 5 of the service request enable register is "1", bit 6 (MSS) will be set to "1", thus requesting service from the controller. It is also possible to check what type of event has occurred by reading the contents of the status byte.

### Reading from the Status Byte

The following two methods are provided for reading the status byte.

- **Query using the \*STB? query**

Making a query using the \*STB? query sets bit 6 to MSS. This causes the MSS to be read. After completion of the read-out, none of the bits in the status byte will be cleared.

- **Serial poll**

Execution of a serial poll changes bit 6 to RQS. This causes RQS to be read. After completion of the read-out, only RQS is cleared. Using a serial poll, it is not possible to read MSS.

### Clearing the Status Byte

No method is provided for forcibly clearing all the bits in the status byte. Bits which are cleared are shown below.

- **When a query is made using the \*STB? query**

No bit is cleared.

- **When a serial poll is performed**

Only the RQS bit is cleared.

- **When the \*CLS command is received**

When the \*CLS command is received, the status byte itself is not cleared, but the contents of the standard event register (which affects the bits in the status byte) are cleared. As a result, the corresponding bits in the status byte are cleared, except bit 4 (MAV), since the output queue cannot be emptied by the \*CLS command. However, the output queue will also be cleared if the \*CLS command is received just after a program message terminator.

## 2.4.3 Standard Event Register

### Overview of the Standard Event Register

|     |     |     |     |     |     |     |     |
|-----|-----|-----|-----|-----|-----|-----|-----|
| 7   | 6   | 5   | 4   | 3   | 2   | 1   | 0   |
| PON | URQ | CME | EXE | DDE | QYE | RQC | OPC |

- **Bit 7 PON (Power ON)**

Set to "1" when power to the instrument is turned ON

- **Bit 6 URQ (User Request)**

Not used (always "0")

- **Bit 5 CME (Command Error)**

Set to "1" when the command syntax is incorrect.

Examples: Incorrectly spelled command name

- **Bit 4 EXE (Execution Error)**

Set to "1" when the command syntax is correct but the command cannot be executed in the current state.

Examples: Parameters are outside the setting range.

- **Bit 3 DDE (Device Error)**

Set to "1" when execution of the command is not possible due to an internal problem in the instrument that is not a command error or an execution error.

- **Bit 2 QYE (Query Error)**

Set to "1" if the output queue is empty or if the data is missing even after a query has been sent.

Examples: No response data; data is lost due to an overflow in the output queue.

- **Bit 1 RQC (Request Control)**

Not used (always "0")

- **Bit 0 OPC (Operation Complete)**

Set to "1" when the operation designated by the \*OPC command has been completed.

### Bit Masking

To mask a bit in the standard event register so that it does not cause bit 5 (ESB) of the status byte to change, set the corresponding bit in the standard event enable register to "0". For example, to mask bit 2 (QYE) so that ESB will not be set to "1", even if a query error occurs, set bit 2 of the standard event enable register to "0". This can be done using the \*ESE command. To query whether each bit of the standard event enable register is "1" or "0", use the \*ESE?. For details of the \*ESE command, refer to Appendix 2.3.

### Operation of the Standard Event Register

The standard event register is provided for eight different kinds of event which can occur inside the instrument. Bit 5 (ESB) of the status byte is set to "1" when any of the bits in this register becomes "1" (or when the corresponding bit of the standard event enable register becomes "1").

Examples

1. A query error occurs.
2. Bit 2 (QYE) is set to "1".
3. Bit 5 (ESB) of the status byte is set to "1" if bit 2 of the standard event enable register is "1"

It is also possible to check what type of event has occurred inside the instrument by reading the contents of the standard event register.

### Reading from the Standard Event Register

The contents of the standard event register can be read by the \*ESR command. After completion of the read-out, the register will be cleared.

### Clearing the Standard Event Register

The standard event register is cleared in the following three cases.

- When the contents of the standard event register are read using \*ESR?
- When the \*CLS command is received
- When power is turned ON again

## 2.4.4 Extended Event Register

The extended event register contains the results obtained due to a change in state of the condition register (indicating the internal state of the instrument) which is detected by the transit filter.

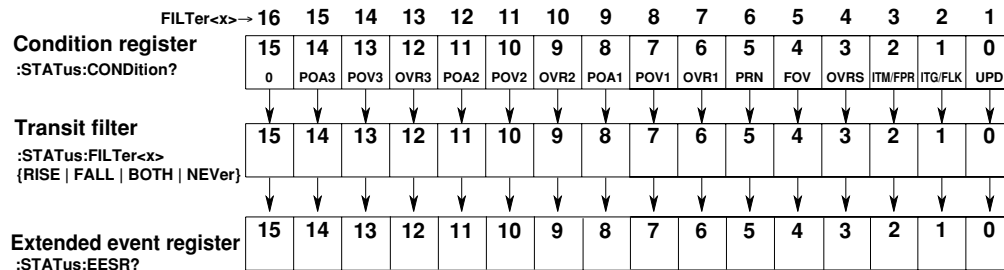

Function of each bit of the condition register is described below.

|        |   |   |
|--------|---|---|
| Bit 0  | UPD(Updating)                                     | Bit 0 Set to "1" during update of measured data. UPD changes from "1" to "0" when update is complete.   |
| Bit 1  | ITG(Integrate busy)<br>FLK (Flicker busy)         | Set to "1" during integration. (See the figure below.)<br>Set to "1" while measurement of voltage fluctuation is in operation in flicker measurement mode. (See the next page.)   |
| Bit 2  | ITM(Integrate timer busy)<br>FPR (Flicker period) | Set to "1" while integration time is in operation. (See the figure below.)<br>Set to "1" while measurement of voltage fluctuation for each observation period is in operation in flicker measurement mode. (See the next page.) |
| Bit 3  | OVRS( $\Sigma$ results overflow)                  | Set to "1" when an overflow occurs in measured/computed data ( $\Sigma$ and computation result) for which the element cannot be identified. ("--oF--" is displayed.)  |
| Bit 4  | FOV(Frequency Over)                               | Set to "1" when the measured frequency is outside the range. ("ErrLo", "ErrHi" or "FrqEr" is displayed.)  |
| Bit 5  | PRN(PRInter busy)                                 | Set to "1" while the built-in printer is in operation.  |
| Bit 6  | OVR1(Element1 measured data over)                 | Set to "1" when an overflow or error occurs in measured/computed data for element 1. ("--oL--", "PFErr", "dEGEr" or "--oF--" is displayed.)   |
| Bit 7  | POV1(Element1 voltage peak over)                  | Set to "1" when a peak over occurs in voltage value for element 1.  |
| Bit 8  | POA1(Element1 current peak over)                  | Set to "1" when a peak over occurs in current value for element 1.  |
| Bit 9  | OVR2(Element2 measured data over)                 | Set to "1" when an overflow or error occurs in measured/computed data for element 2. ("--oL--", "PFErr", "dEGEr" or "--oF--" is displayed.)   |
| Bit 10 | POV2(Element2 voltage peak over)                  | Set to "1" when a peak over occurs in voltage value for element 2.  |
| Bit 11 | POA2(Element2 current peak over)                  | Set to "1" when a peak over occurs in current value for element 2.  |
| Bit 12 | OVR3(Element3 measured data over)                 | Set to "1" when an overflow or error occurs in measured/computed data for element 3. ("--oL--", "PFErr", "dEGEr" or "--oF--" is displayed.)   |
| Bit 13 | POV3(Element3 voltage peak over)                  | Set to "1" when a peak over occurs in voltage value for element 3.  |
| Bit 14 | POA3(Element3 current peak over)                  | Set to "1" when a peak over occurs in current value for element 3.  |

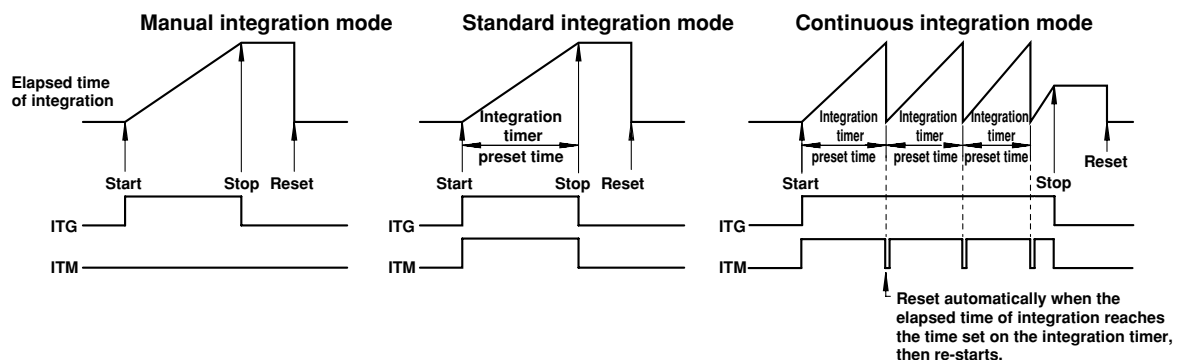

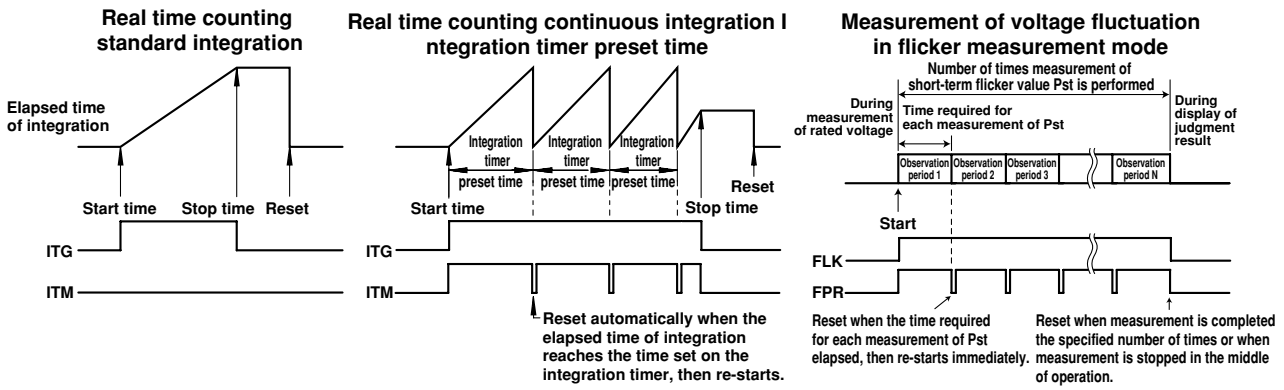

Parameters of the transit filter detect a change in the specified bit of the condition register, then re-write the contents of the extended event register as shown below.

|       |   |
|-------|---|
| RISE  | Sets the specified bit of the extended event register to "1" when changes from "0" to "1".                    |
| FALL  | Sets the specified bit of the extended event register to "1" when changes from "1" to "0".                    |
| BOTH  | Sets the specified bit of the extended event register to "1" when changes from "0" to "1" or from "1" to "0". |
| NEVER | Always set to "0".  |

### 2.4.5 Output Queue and Error Queue

#### Overview of the Output Queue

The output queue is provided to store response messages to queries. For example, when the MEASure[ :NORMal ] :VALue? query is sent to request output of the measured data, the response data will be stored in the output queue until it is read out. The example below shows that data is stored record by record in the output queue, and is read out oldest item first, newest item last. The output queue is emptied in the following cases (in addition to when read-out is performed).

- When a new message is received from the controller
- When dead lock occurs (page App 2-4)
- When a device clear command (DCL or SDC) is received
- When power is turned ON again

The output queue cannot be emptied using the \*CLS command. To see whether the output queue is empty or not, check bit 4 (MAV) of the status byte.

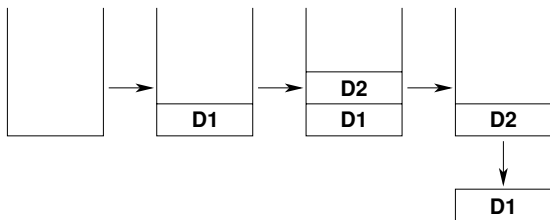

#### Overview of the Error Queue

The error queue stores the error No. and message when an error occurs. For example, when the controller sends an incorrect program message, an error occurs and its error No. 113 and message "Undefined header" will be stored in the error queue. The contents of the error queue can be read using the STATus:ERROR? query. Like the output queue, messages are read in the order oldest first, newest last. If the error queue is full, the final message will be replaced by message 350, "Queue overflow"

The error queue is emptied in the following cases (in addition to when read-out is performed).

- When the \*CLS command is received
- When power is turned ON again

To see whether the error queue is empty or not, check bit 2 (EAV) of the status byte.

## Appendix 2.5 Sample Programs

### Operating Environment for Sample Programs

- Computer : IBM PC/AT and compatible system with National Instruments AT-GPIB/TNT IEEE-488.2 board installed
- OS : Quick Basic version 4.0/4.5

#### Note

- When the message of GPIBERR or DVMERR is returned, refer to "NI-488.2 Driver Sample Programs".

### Sample Programs

```

*****
*
* Sample Program (1) for the WT2000 series
*
* Used to set measurement conditions/ranges for normal measurement mode, and read
* and display the following data each time measured/computed data is updated.
* Voltage (V), current (A), active power (W), voltage frequency (VHz)
*
*****
REM $INCLUDE: 'qbdecl.bas'
DECLARE SUB gpiberr (msg$)
DECLARE SUB dvmerr (msg$, SPR%)
DIM D$(13)
CLS
PRINT
CALL IBDEV(0, 1, 0, T10s, 1, 0, dvm%)
CALL IBFIND("DEV1", dvm%)
IF (dvm% < 0) THEN CALL gpiberr("Ibdev Error")
' clear the device.
CALL IBCLR(dvm%)
IF (IBSTA% AND EERR) THEN CALL gpiberr("Ibclr Error")
' set measurement condition.
WRT$ = "SAMPLE:RATE 0.5S;HOLD OFF"
CALL IBWRT(dvm%, WRT$)
IF (IBSTA% AND EERR) THEN CALL gpiberr("Ibwrt Error")
WRT$ = "VOLTAGE:MODE RMS"
CALL IBWRT(dvm%, WRT$)
IF (IBSTA% AND EERR) THEN CALL gpiberr("Ibwrt Error")
WRT$ = "CURRENT:MODE RMS"
CALL IBWRT(dvm%, WRT$)
IF (IBSTA% AND EERR) THEN CALL gpiberr("Ibwrt Error")
WRT$ = "FILTER OFF"
CALL IBWRT(dvm%, WRT$)
IF (IBSTA% AND EERR) THEN CALL gpiberr("Ibwrt Error")
WRT$ = "SCALING OFF;AVERAGING OFF"
CALL IBWRT(dvm%, WRT$)
IF (IBSTA% AND EERR) THEN CALL gpiberr("Ibwrt Error")
WRT$ = "VOLTAGE:RANGE 100V"
CALL IBWRT(dvm%, WRT$)
IF (IBSTA% AND EERR) THEN CALL gpiberr("Ibwrt Error")
WRT$ = "CURRENT:RANGE 5A"
CALL IBWRT(dvm%, WRT$)
IF (IBSTA% AND EERR) THEN CALL gpiberr("Ibwrt Error")
WRT$ = "DISPLAY4:FUNCTION VHZ;ELEMENT 1"
CALL IBWRT(dvm%, WRT$)
IF (IBSTA% AND EERR) THEN CALL gpiberr("Ibwrt Error")
WRT$ = "MEASURE:ITEM:PRESET DEFAULT1"
CALL IBWRT(dvm%, WRT$)
IF (IBSTA% AND EERR) THEN CALL gpiberr("Ibwrt Error")
WRT$ = "MEASURE:FORMAT ASCII"
CALL IBWRT(dvm%, WRT$)
IF (IBSTA% AND EERR) THEN CALL gpiberr("Ibwrt Error")
FOR J = 1 TO 50000: NEXT J
WRT$ = "STATUS:FILTER1 FALL"
CALL IBWRT(dvm%, WRT$)
IF (IBSTA% AND EERR) THEN CALL gpiberr("Ibwrt Error")
FOR I = 1 TO 10
WRT$ = "STATUS:EESR?"
CALL IBWRT(dvm%, WRT$)
IF (IBSTA% AND EERR) THEN CALL gpiberr("Ibwrt Error")
WRT$ = "COMMUNICATE:WAIT 1"
CALL IBWRT(dvm%, WRT$)
IF (IBSTA% AND EERR) THEN CALL gpiberr("Ibwrt Error")
WRT$ = "MEASURE:VALUE?"
CALL IBWRT(dvm%, WRT$)
IF (IBSTA% AND EERR) THEN CALL gpiberr("Ibwrt Error")
' read measurement data.
RD$ = SPACE$(512)
CALL IBRD(dvm%, RD$)
IF (IBSTA% AND EERR) THEN CALL gpiberr("Ibrd Error")
C$ = RD$
FOR K = 0 TO 12
L = INSTR(C$, " ")
B = INSTR(C$, ",")
IF B = 0 THEN B = INSTR(C$, " ")
D$(K) = LEFT$(C$, (B - 1))
C$ = MID$(C$, (B + 1), L)
NEXT K
PRINT "ELEMENT1: ", D$(0), D$(1), D$(2)
PRINT "ELEMENT2: ", D$(3), D$(4), D$(5)
PRINT "ELEMENT3: ", D$(6), D$(7), D$(8)
PRINT "SUM : ", D$(9), D$(10), D$(11)
PRINT "Frquency: ", D$(12)
NEXT I
' Call the IBONL function to disable the hardware and software.
CALL IBONL(dvm%, 0)
END

```



## Appendix 2.5 Sample Programs

```

*****
*
* Sample Program (2) for the WT2000 series
*
* Used to carry out integration in standard integration mode, and read
* and display the following data each time measured/computed data is updated.
* Active power (W), watt-hour (Wh, Wh+, Wh-), ampere-hour (Ah, Ah+, Ah-),
* elapsed time of integration (IMTEG-TIME)
*
*****
REM $INCLUDE: 'qbdecl.bas'

DECLARE SUB gpiberr (msg$)
DECLARE SUB dvmerr (msg$, SPR%)

DIM D$(28)

CLS
PRINT

CALL IBDEV(0, 1, 0, T10s, 1, 0, dvm%)
IF (dvm% < 0) THEN CALL gpiberr("Ibdev Error")

' clear the device.
CALL IBCLR(dvm%)
IF (IBSTA% AND EERR) THEN CALL gpiberr("Ibclr Error")

' set measurement condition.
WRT$ = "SAMPLE:HOLD OFF"
CALL IBWRT(dvm%, WRT$)
IF (IBSTA% AND EERR) THEN CALL gpiberr("Ibwrt Error")

WRT$ = "VOLTAGE:MODE RMS"
CALL IBWRT(dvm%, WRT$)
IF (IBSTA% AND EERR) THEN CALL gpiberr("Ibwrt Error")

WRT$ = "CURRENT:MODE RMS"
CALL IBWRT(dvm%, WRT$)
IF (IBSTA% AND EERR) THEN CALL gpiberr("Ibwrt Error")

WRT$ = "FILTER OFF"
CALL IBWRT(dvm%, WRT$)
IF (IBSTA% AND EERR) THEN CALL gpiberr("Ibwrt Error")

WRT$ = "SCALING OFF;AVERAGING OFF"
CALL IBWRT(dvm%, WRT$)
IF (IBSTA% AND EERR) THEN CALL gpiberr("Ibwrt Error")

WRT$ = "VOLTAGE:RANGE 100V"
CALL IBWRT(dvm%, WRT$)
IF (IBSTA% AND EERR) THEN CALL gpiberr("Ibwrt Error")

WRT$ = "CURRENT:RANGE 5A"
CALL IBWRT(dvm%, WRT$)
IF (IBSTA% AND EERR) THEN CALL gpiberr("Ibwrt Error")

WRT$ = "INTEGRATE:MODE NORMAL"
CALL IBWRT(dvm%, WRT$)
IF (IBSTA% AND EERR) THEN CALL gpiberr("Ibwrt Error")

WRT$ = "INTEGRATE:TIMER 1,0"
CALL IBWRT(dvm%, WRT$)
IF (IBSTA% AND EERR) THEN CALL gpiberr("Ibwrt Error")

WRT$ = "MEASURE:ITEM:PRESET DEFAULT2"
CALL IBWRT(dvm%, WRT$)
IF (IBSTA% AND EERR) THEN CALL gpiberr("Ibwrt Error")

WRT$ = "MEASURE:ITEM:FREQUENCY OFF;AH OFF;AHP OFF;AHM OFF"
CALL IBWRT(dvm%, WRT$)
IF (IBSTA% AND EERR) THEN CALL gpiberr("Ibwrt Error")

WRT$ = "MEASURE:FORMAT ASCII"
CALL IBWRT(dvm%, WRT$)
IF (IBSTA% AND EERR) THEN CALL gpiberr("Ibwrt Error")

'wait
FOR I = 1 TO 500000: NEXT I

WRT$ = "STATUS:FILTER1 FALL"
CALL IBWRT(dvm%, WRT$)
IF (IBSTA% AND EERR) THEN CALL gpiberr("Ibwrt Error")

WRT$ = "STATUS:FILTER2 FALL"
CALL IBWRT(dvm%, WRT$)
IF (IBSTA% AND EERR) THEN CALL gpiberr("Ibwrt Error")

WRT$ = "STATUS:EESR?"
CALL IBWRT(dvm%, WRT$)
IF (IBSTA% AND EERR) THEN CALL gpiberr("Ibwrt Error")

RD$ = SPACE$(10)
CALL IBRD(dvm%, RD$)
IF (IBSTA% AND EERR) THEN CALL gpiberr("Ibrd Error")

WRT$ = "INTEGRATE:START"
CALL IBWRT(dvm%, WRT$)
IF (IBSTA% AND EERR) THEN CALL gpiberr("Ibwrt Error")
FLAG = 0
RDDAT:
WRT$ = "COMMUNICATE:WAIT 3"
CALL IBWRT(dvm%, WRT$)
IF (IBSTA% AND EERR) THEN CALL gpiberr("Ibwrt Error")

WRT$ = "STATUS:EESR?"
CALL IBWRT(dvm%, WRT$)
IF (IBSTA% AND EERR) THEN CALL gpiberr("Ibwrt Error")

RD$ = SPACE$(10)
CALL IBRD(dvm%, RD$)
IF (IBSTA% AND EERR) THEN CALL gpiberr("Ibrd Error")

IF (VAL(RD$) AND &H2) <> 0 THEN FLAG = 1

WRT$ = "MEASURE:VALUE?"
CALL IBWRT(dvm%, WRT$)
IF (IBSTA% AND EERR) THEN CALL gpiberr("Ibwrt Error")

RD$ = SPACE$(512)
CALL IBRD(dvm%, RD$)
IF (IBSTA% AND EERR) THEN CALL gpiberr("Ibrd Error")

C$ = LEFT$(RD$, IBCNT%)
FOR K = 0 TO 27
  L = LEN(C$)
  B = INSTR(C$, " ")
  IF B = 0 THEN B = L + 1
  D$(K) = LEFT$(C$, (B - 1))
  C$ = MID$(C$, (B + 1), L)
NEXT K
PRINT "Itg Time: ", D$(1) + " " + D$(2) + " " + D$(3)
PRINT "ELEMENT1: ", D$(4), D$(5), D$(6)
PRINT "ELEMENT2: ", D$(7), D$(11), D$(12), D$(13)
PRINT "ELEMENT3: ", D$(14), D$(18), D$(19), D$(20)
PRINT "SUM      : ", D$(21), D$(25), D$(26), D$(27)
PRINT

IF FLAG <> 1 THEN GOTO RDDAT

' Call the IBONL function to disable the hardware and software.
CALL IBONL(dvm%, 0)

```

END

```

*****
*
* Sample Program (3) for the WT2000 series
*
* Used to read and display the following data in harmonic analysis mode.
* Total rms value of each harmonic from 1st to 50th of current.
* analysis value of fundamental (1st) of current, analysis value of each harmonic
* (2nd to 50th), harmonic distortion of current, PLL source (voltage) frequency
*
*****
REM $INCLUDE: 'qbdecl.bas'

DIM D$(52)

DECLARE SUB gpiberr (msg$)
DECLARE SUB dvmerr (msg$, SPR%)

CLS
PRINT

CALL IBDEV(0, 1, 0, T10s, 1, 0, dvm%)
IF (dvm% < 0) THEN CALL gpiberr("Ibdev Error")

' clear the device.
CALL IBCLR(dvm%)
IF (IBSTA% AND EERR) THEN CALL gpiberr("Ibclr Error")

' set measurement condition.
WRT$ = "HARMONICS:SYNCHRONIZE V,1"
CALL IBWRT(dvm%, WRT%)
IF (IBSTA% AND EERR) THEN CALL gpiberr("Ibwrt Error")

WRT$ = "HARMONICS:FILTER OFF"
CALL IBWRT(dvm%, WRT%)
IF (IBSTA% AND EERR) THEN CALL gpiberr("Ibwrt Error")

WRT$ = "HARMONICS:THD IEC"
CALL IBWRT(dvm%, WRT%)
IF (IBSTA% AND EERR) THEN CALL gpiberr("Ibwrt Error")

WRT$ = "HARMONICS:ORDER 50"
CALL IBWRT(dvm%, WRT%)
IF (IBSTA% AND EERR) THEN CALL gpiberr("Ibwrt Error")

WRT$ = "HARMONICS ON"
CALL IBWRT(dvm%, WRT%)
IF (IBSTA% AND EERR) THEN CALL gpiberr("Ibwrt Error")

FOR I = 1 TO 1000000: NEXT I

WRT$ = "MEASURE:ITEM:HARMONICS:PRESET CLEAR"
CALL IBWRT(dvm%, WRT%)
IF (IBSTA% AND EERR) THEN CALL gpiberr("Ibwrt Error")

WRT$ = "MEASURE:ITEM:HARMONICS:A:ELEMENT1 ON"
CALL IBWRT(dvm%, WRT%)
IF (IBSTA% AND EERR) THEN CALL gpiberr("Ibwrt Error")

WRT$ = "MEASURE:ITEM:HARMONICS:ATHD:ELEMENT1 ON"
CALL IBWRT(dvm%, WRT%)
IF (IBSTA% AND EERR) THEN CALL gpiberr("Ibwrt Error")

WRT$ = "MEASURE:ITEM:HARMONICS:SYNCHRONIZE ON"
CALL IBWRT(dvm%, WRT%)
IF (IBSTA% AND EERR) THEN CALL gpiberr("Ibwrt Error")

WRT$ = "MEASURE:FORMAT ASCII"
CALL IBWRT(dvm%, WRT%)
IF (IBSTA% AND EERR) THEN CALL gpiberr("Ibwrt Error")

WRT$ = "SAMPLE:HOLD ON"
CALL IBWRT(dvm%, WRT%)
IF (IBSTA% AND EERR) THEN CALL gpiberr("Ibwrt Error")

WRT$ = "MEASURE:VALUE?"
CALL IBWRT(dvm%, WRT%)
IF (IBSTA% AND EERR) THEN CALL gpiberr("Ibwrt Error")

' read measurement data.
RD$ = SPACE$(1024)
CALL IBRD(dvm%, RD$)
IF (IBSTA% AND EERR) THEN CALL gpiberr("Ibrd Error")

C$ = LEFT$(RD$, IBCNT%)
FOR J = 0 TO 52
  L = LEN(C$)
  B = INSTR(C$, ",")
  IF B = 0 THEN B = L + 1
  D$(J) = LEFT$(C$, (B - 1))
  C$ = MID$(C$, (B + 1), L)
NEXT J

PRINT "TOTAL      : ", D$(0)
PRINT "FREQUENCY: ", D$(52)
PRINT " 1:" D$(1), " 2:" D$(2)
PRINT " 3:" D$(3), " 4:" D$(4)
PRINT " 5:" D$(5), " 6:" D$(6)
PRINT " 7:" D$(7), " 8:" D$(8)
PRINT " 9:" D$(9), " 10:" D$(10)
PRINT "11:" D$(11), " 12:" D$(12)
PRINT "13:" D$(13), " 14:" D$(14)
PRINT "15:" D$(15), " 16:" D$(16)
PRINT "17:" D$(17), " 18:" D$(18)
PRINT "19:" D$(19), " 20:" D$(20)
PRINT "21:" D$(21), " 22:" D$(22)
PRINT "23:" D$(23), " 24:" D$(24)
PRINT "25:" D$(25), " 26:" D$(26)
PRINT "27:" D$(27), " 28:" D$(28)
PRINT "29:" D$(29), " 30:" D$(30)
PRINT "31:" D$(31), " 32:" D$(32)
PRINT "33:" D$(33), " 34:" D$(34)
PRINT "35:" D$(35), " 36:" D$(36)
PRINT "37:" D$(37), " 38:" D$(38)
PRINT "39:" D$(39), " 40:" D$(40)
PRINT "41:" D$(41), " 42:" D$(42)
PRINT "43:" D$(43), " 44:" D$(44)
PRINT "45:" D$(45), " 46:" D$(46)
PRINT "47:" D$(47), " 48:" D$(48)
PRINT "49:" D$(49), " 50:" D$(50)
PRINT "THD:" D$(51)

WRT$ = "SAMPLE:HOLD OFF"
CALL IBWRT(dvm%, WRT%)
IF (IBSTA% AND EERR) THEN CALL gpiberr("Ibwrt Error")

' Call the IBONL function to disable the hardware and software.
CALL IBONL(dvm%, 0)

END

```

## Appendix 2.5 Sample Programs

```

*****
*
* Sample Program (4) for the WT2000 series
*
* Used to set measurement conditions/ranges for normal measurement mode, and read
* and display the following data each time measured/computed data is updated.
* Binary data: voltage (V), current (A), active power (W), voltage frequency (VHz)
*
*****

REM $INCLUDE: 'qbdecl.bas'

DECLARE SUB gpiberr (msg$)
DECLARE SUB dvmerr (msg$, SPR%)

DIM DT(13)

CLS
PRINT

CALL IBDEV(0, 1, 0, T10s, 1, 0, dvm%)
IF (dvm% < 0) THEN CALL gpiberr("Ibdev Error")

'clear the device.
CALL IBCLR(dvm%)
IF (IBSTA% AND EERR) THEN CALL gpiberr("Ibclr Error")

'set measurement condition.
WRT$ = "SAMPLE:RATE 0.5S;HOLD OFF"
CALL IBWRT(dvm%, WRT$)
IF (IBSTA% AND EERR) THEN CALL gpiberr("Ibwrt Error")

WRT$ = "VOLTAGE:MODE RMS"
CALL IBWRT(dvm%, WRT$)
IF (IBSTA% AND EERR) THEN CALL gpiberr("Ibwrt Error")

WRT$ = "CURRENT:MODE RMS"
CALL IBWRT(dvm%, WRT$)
IF (IBSTA% AND EERR) THEN CALL gpiberr("Ibwrt Error")

WRT$ = "FILTER OFF"
CALL IBWRT(dvm%, WRT$)
IF (IBSTA% AND EERR) THEN CALL gpiberr("Ibwrt Error")

WRT$ = "SCALING OFF;AVERAGING OFF"
CALL IBWRT(dvm%, WRT$)
IF (IBSTA% AND EERR) THEN CALL gpiberr("Ibwrt Error")

WRT$ = "VOLTAGE:RANGE 100V"
CALL IBWRT(dvm%, WRT$)
IF (IBSTA% AND EERR) THEN CALL gpiberr("Ibwrt Error")

WRT$ = "CURRENT:RANGE 5A"
CALL IBWRT(dvm%, WRT$)
IF (IBSTA% AND EERR) THEN CALL gpiberr("Ibwrt Error")

WRT$ = "DISPLAY4:FUNCTION VHZ;ELEMENT 1"
CALL IBWRT(dvm%, WRT$)
IF (IBSTA% AND EERR) THEN CALL gpiberr("Ibwrt Error")

WRT$ = "MEASURE:ITEM:PRESET DEFAULT1"
CALL IBWRT(dvm%, WRT$)
IF (IBSTA% AND EERR) THEN CALL gpiberr("Ibwrt Error")

WRT$ = "MEASURE:FORMAT BINARY"
CALL IBWRT(dvm%, WRT$)
IF (IBSTA% AND EERR) THEN CALL gpiberr("Ibwrt Error")

FOR I = 1 TO 500000: NEXT I

WRT$ = "STATUS:FILTER1 FALL"
CALL IBWRT(dvm%, WRT$)
IF (IBSTA% AND EERR) THEN CALL gpiberr("Ibwrt Error")

FOR I% = 1 TO 10
WRT$ = "STATUS:EESR?"
CALL IBWRT(dvm%, WRT$)
IF (IBSTA% AND EERR) THEN CALL gpiberr("Ibwrt Error")

RD$ = SPACE$(10)
CALL IBRD(dvm%, RD$)
IF (IBSTA% AND EERR) THEN CALL gpiberr("Ibrd Error")

WRT$ = "COMMUNICATE:WAIT 1"
CALL IBWRT(dvm%, WRT$)
IF (IBSTA% AND EERR) THEN CALL gpiberr("Ibwrt Error")

WRT$ = "MEASURE:VALUE?"
CALL IBWRT(dvm%, WRT$)
IF (IBSTA% AND EERR) THEN CALL gpiberr("Ibwrt Error")

'read measurement data.
RD$ = SPACE$(512)
CALL IBRD(dvm%, RD$)
IF (IBSTA% AND EERR) THEN CALL gpiberr("Ibrd Error")

N = 0
FOR J = 7 TO 58 STEP 4
P$ = MID$(RD$, J + 3, 1): SP = CVI(P$ + CHR$(0))
Q$ = MID$(RD$, J + 2, 1): SQ = CVI(Q$ + CHR$(0))
R$ = MID$(RD$, J + 1, 1): SR = CVI(R$ + CHR$(0))
T$ = MID$(RD$, J + 0, 1): SS = CVI(T$ + CHR$(0))
T$ = RIGHT$("0" + HEX$(SS), 2) + RIGHT$("0" + HEX$(SR), 2) + R
IGHTS("0" + HEX$(SQ), 2) + RIGHT$("0" + HEX$(SP), 2)
FOR K = 1 TO 8
A$(K) = MID$(T$, K, 1)
IF A$(K) = "0" THEN b$(K) = "0000"
IF A$(K) = "1" THEN b$(K) = "0001"
IF A$(K) = "2" THEN b$(K) = "0010"
IF A$(K) = "3" THEN b$(K) = "0011"
IF A$(K) = "4" THEN b$(K) = "0100"
IF A$(K) = "5" THEN b$(K) = "0101"
IF A$(K) = "6" THEN b$(K) = "0110"
IF A$(K) = "7" THEN b$(K) = "0111"
IF A$(K) = "8" THEN b$(K) = "1000"
IF A$(K) = "9" THEN b$(K) = "1001"
IF A$(K) = "A" THEN b$(K) = "1010"
IF A$(K) = "B" THEN b$(K) = "1011"
IF A$(K) = "C" THEN b$(K) = "1100"
IF A$(K) = "D" THEN b$(K) = "1101"
IF A$(K) = "E" THEN b$(K) = "1110"
IF A$(K) = "F" THEN b$(K) = "1111"
NEXT K
b$ = b$(1) + b$(2) + b$(3) + b$(4) + b$(5) + b$(6) + b$(7) + b$(8)
U = 0: E = 0: F = 0
U = VAL(LEFT$(b$, 1))
E$ = MID$(b$, 2, 8)
FOR L = 0 TO 7
E = E + (2 ^ L) * VAL(MID$(E$, (8 - L), 1))
NEXT L
W$ = MID$(b$, 10, 23)
FOR M = 1 TO 23
F = F + (2 ^ (-M)) * VAL(MID$(W$, M, 1))
NEXT M
F = F + 1
DT(N) = ((-1) ^ U) * (2 ^ (E - 127)) * F
IF DT(N) < 1E-12 THEN DT(N) = 0
N = N + 1

```

```
      NEXT J
      PRINT "MEASURE DATA"
      PRINT "ELEMENT1 : ", DT(0), DT(1), DT(2)
      PRINT "ELEMENT2 : ", DT(3), DT(4), DT(5)
      PRINT "ELEMENT3 : ", DT(6), DT(7), DT(8)
      PRINT "SUM      : ", DT(9), DT(10), DT(11)
      PRINT "FREQUENCY: ", DT(12)

      NEXT I%
' Call the IBONL function to disable the hardware and software.
CALL IBONL(dvm%, 0)
END
```

## Appendix 2.6 ASCII Character Code

ASCII character codes are given below.

|   | 0               | 1                 | 2                | 3       | 4              | 5        | 6              | 7                   |
|---|-----------------|-------------------|------------------|---------|----------------|----------|----------------|---------------------|
| 0 | 0<br>NUL        | 20<br>DEL         | 40<br>SP         | 60<br>0 | 100<br>@       | 120<br>P | 140<br>'       | 160<br>p            |
| 1 | 1<br>SOH        | 21<br>DC1         | 41<br>!          | 61<br>1 | 101<br>A       | 121<br>Q | 141<br>a       | 161<br>q            |
| 2 | 2<br>STX        | 22<br>DC2         | 42<br>"          | 62<br>2 | 102<br>B       | 122<br>R | 142<br>b       | 162<br>r            |
| 3 | 3<br>ETX        | 23<br>DC3         | 43<br>#          | 63<br>3 | 103<br>C       | 123<br>S | 143<br>c       | 163<br>s            |
| 4 | 4<br>EOT        | 24<br>DC4         | 44<br>\$         | 64<br>4 | 104<br>D       | 124<br>T | 144<br>d       | 164<br>t            |
| 5 | 5<br>ENQ        | 25<br>NAK         | 45<br>%          | 65<br>5 | 105<br>E       | 125<br>U | 145<br>e       | 165<br>u            |
| 6 | 6<br>ACK        | 26<br>SYN         | 46<br>&          | 66<br>6 | 106<br>F       | 126<br>V | 146<br>f       | 166<br>v            |
| 7 | 7<br>BEL        | 27<br>ETB         | 47<br>,          | 67<br>7 | 107<br>G       | 127<br>W | 147<br>g       | 167<br>w            |
| 8 | 10<br>BS        | 30<br>CAN         | 50<br>(          | 70<br>8 | 110<br>H       | 130<br>X | 150<br>h       | 170<br>x            |
| 9 | 11<br>HT        | 31<br>EM          | 51<br>)          | 71<br>9 | 111<br>I       | 131<br>Y | 151<br>i       | 171<br>y            |
| A | 12<br>LF        | 32<br>SUB         | 52<br>*          | 72<br>: | 112<br>J       | 132<br>Z | 152<br>j       | 172<br>z            |
| B | 13<br>VT        | 33<br>ESC         | 53<br>+          | 73<br>; | 113<br>K       | 133<br>[ | 153<br>k       | 173<br>{            |
| C | 14<br>FF        | 34<br>FS          | 54<br>,          | 74<br>< | 114<br>L       | 134<br>\ | 154<br>l       | 174<br>             |
| D | 15<br>CR        | 35<br>GS          | 55<br>-          | 75<br>= | 115<br>M       | 135<br>] | 155<br>m       | 175<br>}            |
| E | 16<br>SO        | 36<br>RS          | 56<br>.          | 76<br>> | 116<br>N       | 136<br>^ | 156<br>n       | 176<br>~            |
| F | 17<br>SI        | 37<br>US          | 57<br>/          | 77<br>? | 117<br>O       | 137<br>_ | 157<br>o       | 177<br>DEL (RUBOUT) |
|   | Address Command | Universal Command | Listener Address |         | Talker Address |          | Second Command |                     |

### Example

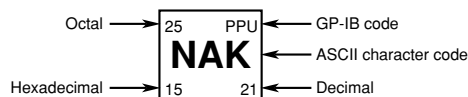

## Appendix 2.7 Communication Error Messages

Error messages related to the 488.2 communication mode are given below.

- When servicing is required, contact your nearest YOKOGAWA representative, listed on the back cover of this manual.
- The following error messages are displayed when a communication command is received in 488.2 communication mode. For a description of errors which occur in a mode other than the 488.2 communication mode or occur when a panel key is pressed, refer to Section 15.2, "Error Codes and Corrective Actions".

### Errors in communication command (100 to 199)

#### Error in communication command

| Code | Message                    | Action Reference   | Page                          |
|------|----------------------------|--|-------------------------------|
| 102  | Syntax error               | Incorrect syntax   | Appendix 2.2,<br>Appendix 2.3 |
| 103  | Invalid separator          | Insert a comma between data items to separate them.                                      | App 2-3                       |
| 104  | Data type error            | Refer to pages App 2-6 to 2-7 and enter using the correct data format.                   | App 2-6,<br>App 2-7           |
| 105  | GET not allowed            | GET is not supported as a response .<br>to an interface message                          | —                             |
| 108  | Parameter not allowed      | Check the number of parameters.  | App 2-6,<br>Appendix 2.3      |
| 109  | Missing parameter          | Enter required parameters.   | App 2-6,<br>Appendix 2.3      |
| 111  | Header separator error     | Insert a space between the header and the data to separate them.                         | App 2-3                       |
| 112  | Program mnemonic too long  | Check the mnemonic (a character string consisting of letters and numbers).               | Appendix 2.3                  |
| 113  | Undefined header           | Check the header.  | Appendix 2.3                  |
| 114  | Header suffix out of range | Check the header.  | Appendix 2.3                  |
| 120  | Numeric data error         | Numeric value must be preceded by a mantissa for <NRf> format.                           | App 2-6                       |
| 123  | Exponent too large         | Use a smaller exponent for <NR3> format.   | App 2-6,<br>Appendix 2.3      |
| 124  | Too many digits            | Limit the number of digits to 255 or less.   | App 2-6,<br>Appendix 2.3      |
| 128  | Numeric data not allowed   | Enter in a format other than <NRf> format.   | App 2-6,<br>Appendix 2.3      |
| 131  | Invalid suffix             | Check the unit for <Voltage> and <Current>.  | App 2-7                       |
| 134  | Suffix too long            | Check the unit for <Voltage> and <Current>.  | App 2-7                       |
| 138  | Suffix not allowed         | No units are allowed other than <Voltage> and <Current>.                                 | App 2-7                       |
| 141  | Invalid character data     | Enter one of the character strings in {...!...l...}.                                     | Appendix 2.3                  |
| 144  | Character data too long    | Check the spelling of the character strings in {...!...l...}.                            | Appendix 2.3                  |
| 148  | Character data not allowed | Enter in a format other than in {...!...l...}.   | Appendix 2.3                  |
| 150  | String data error          | <Character string> must be enclosed by double quotation marks or single quotation marks. | App 2-7                       |
| 151  | Invalid string data        | <Character string> is too long or contains characters which cannot be used.              | Appendix 2.3                  |

## Appendix 2.7 Communication Error Messages

| Code | Message                          | Action Reference  | Page         |
|------|----------------------------------|---|--------------|
| 158  | String data not allowed          | Enter in a data format other than <Character string>.         | Appendix 2.3 |
| 161  | Invalid block data               | <Block data> is not allowed.                                  | —            |
| 168  | Block data not allowed           | <Block data> is not allowed.                                  | —            |
| 171  | Invalid expression               | Equation is not allowed.                                      | Appendix 2.3 |
| 178  | Expression data not allowed      | Equation is not allowed.                                      | Appendix 2.3 |
| 181  | Invalid outside macro definition | Does not conform to the macro function specified in IEEE488.2 | —            |

### Error in communications execution (200 to 299)

#### Error in communication execution

| Code | Message                        | Action Reference  | Page         |
|------|--------------------------------|---|--------------|
| 221  | Setting conflict               | Check the relevant setting.                                   | Appendix 2.3 |
| 222  | Data out of range              | Check the setting range.                                      | Appendix 2.3 |
| 223  | Too much data                  | Check the data byte length.                                   | Appendix 2.3 |
| 224  | Illegal parameter value        | Check the setting range.                                      | Appendix 2.3 |
| 241  | Hardware missing               | Check availability of options.                                | —            |
| 260  | Expression error               | Equation is not allowed.                                      | —            |
| 270  | Macro error                    | Does not conform to the macro function specified in IEEE488.2 | —            |
| 272  | Macro execution error          | Does not conform to the macro function specified in IEEE488.2 | —            |
| 273  | Illegal macro label            | Does not conform to the macro function specified in IEEE488.2 | —            |
| 275  | Macro definition too long      | Does not conform to the macro function specified in IEEE488.2 | —            |
| 276  | Macro recursion error          | Does not conform to the macro function specified in IEEE488.2 | —            |
| 277  | Macro redefinition not allowed | Does not conform to the macro function specified in IEEE488.2 | —            |
| 278  | Macro header not found         | Does not conform to the macro function specified in IEEE488.2 | —            |

**Error in communications query (400 to 499)****Error in communication Query**

| Code | Message                                      | Action Reference   | Page    |
|------|--|--|---------|
| 410  | Query INTERRUPTED                            | Check transmission/reception order.  | App 2-3 |
| 420  | Query UNTERMINATED                           | Check transmission/reception order.  | App 2-3 |
| 430  | Query DEADLOCKED                             | Limit the length of the program message including <PMT> to 1024 bytes or less. | App 2-4 |
| 440  | Query UNTERMINATED after indefinite response | Do not enter any query after *IDN? and *OPT?.                                  | —       |

**Error in Execution (800 to 899)****Error in Execution**

| Code       | Message                      | Action Reference   | Page |
|------------|------------------------------|--|------|
| 813 to 819 | Invalid operation            | For the lower 2 digits of the error code, refer to Section 15.2, "Error Codes and Corrective Actions". | —    |
| 820 to 826 | Flicker execute error        | For the lower 2 digits of the error code, refer to Section 15.2, "Error Codes and Corrective Actions". | —    |
| 830        | Internal memory access error | For the lower 2 digits of the error code, refer to Section 15.2, "Error Codes and Corrective Actions". | —    |
| 841 to 848 | Integrator execute error     | For the lower 2 digits of the error code, refer to Section 15.2, "Error Codes and Corrective Actions". | —    |

**Error in System Operation (912)****Error in System Operation**

| Code | Message                             | Action Reference       | Page |
|------|-------------------------------------|------------------------|------|
| 912  | Fatal error in Communication-driver | Servicing is required. | —    |

**Other errors (350, 390)**

| Code | Message                       | Action Reference                     | Page     |
|------|-------------------------------|--------------------------------------|----------|
| 350  | Queue overflow                | Queue overflow Read the error queue. | App 2-60 |
| 390  | Overrun error (RS-232-C only) | Reduce the baud rate.                | 14-12    |

**Note**

- Code 350 occurs when the error queue is full up. This message is output only for the `STATUS:ERROR?` query and is not displayed on the screen.



# Appendix 3 Print Examples

The print examples given below may differ from the actual print outputs.

## Panel Set-up Information

The following example shows the default settings (factory settings).

|                          |   |   |
|--------------------------|---|---|
| WT2030 Setup Lists       |   | <b>Print date/time</b>  |
| 1996.01.01               |   |   |
| 05:56:35                 |   | <b>Model name</b>   |
| Model Name 253103-C1     |   | <b>Installed options</b>  |
| Option /DA/B5/HRM/FL     |   | <b>Voltage range and measurement mode for each element</b>  |
| U1 Manual 600 Urms       | } | <b>Current range and measurement mode for each element</b>  |
| U2 Manual 600 Urms       |   |   |
| U3 Manual 600 Urms       |   |   |
| A1 Manual 30 Arms        | } | <b>External shunt current value</b>   |
| A2 Manual 30 Arms        |   |   |
| A3 Manual 30 Arms        |   |   |
| Ext.Shunt(A1) 50.000A/FS | } | <b>External shunt current value</b>   |
| Ext.Shunt(A2) 50.000A/FS |   |   |
| Ext.Shunt(A3) 50.000A/FS |   |   |
| Display A U 1            | } | <b>Display element</b>  |
| Display B A 1            |   |   |
| Display C W 1            |   |   |
| Display D W 1            |   |   |
| Wiring 1+2w              |   | <b>Wiring system</b>  |
| Filter Off               |   | <b>Line filter ON/OFF</b>   |
| Cut Off Frequency 500Hz  |   | <b>Cut-off frequency</b>  |
| Peak Hold Off            |   | <b>Peak hold ON/OFF</b>   |
| Peak Hold Function Peak  |   | <b>Peak hold function</b>   |
| Frequency Filter Off     |   | <b>Frequency filter ON/OFF</b>  |
| Null Function Off        |   | <b>NULL function ON/OFF</b>   |
| Crest Factor 3           |   | <b>Crest factor</b>   |
| Degree -180<=des<=180    |   | <b>Phase angle display method</b>   |
| Scaling Off              | } | <b>Scaling ON/OFF and scaling values</b>  |
| PT Ratio 1 1.0000        |   |   |
| CT Ratio 1 1.0000        |   |   |
| Scaling Factor 1 1.0000  |   |   |
| PT Ratio 2 1.0000        |   |   |
| CT Ratio 2 1.0000        |   |   |
| Scaling Factor 2 1.0000  |   |   |
| PT Ratio 3 1.0000        |   |   |
| CT Ratio 3 1.0000        |   |   |
| Scaling Factor 3 1.0000  |   |   |
| Averaging Off            | } | <b>Averaging ON/OFF, averaging type and coefficient</b>   |
| Avg Type EXP.            |   |   |
| Avg Coefficient 8        |   |   |
| Hold Off                 |   | <b>Hold ON/OFF</b>  |
| Sample Rate 500ms        |   | <b>Sample rate</b>  |
| Mathematics Eff          |   | <b>MATH setting</b>   |
| Integ. Mode Manual       | } | <b>Integration mode and integration timer preset time</b>   |
| Integ. Timer 000h00m     |   |   |
| Rated Time(DA) 001h00m   |   |   |
| Auto Print Off           | } | <b>Auto print ON/OFF, print synchronous method and print interval</b>   |
| Print Sync. Timer        |   |   |
| Print Interval 00h01m00s |   |   |
| Harmonic Off             | } | <b>Harmonic analysis ON/OFF, display mode, PLL source, upper limit of the harmonic order(Setting Max Order), computation method, anti-aliasing filter ON/OFF, analysis window width</b>   |
| Disp. B Format Value     |   |   |
| Sync. Source PLL U1      |   |   |
| Setting MaxOrder 50      |   |   |
| THD Formula IEC          |   |   |
| Disp. A Order 1          |   |   |
| Anti-Aliasing Filt. Off  |   |   |
| Window Width 16          |   |   |
| Flicker Off              | } | <b>Voltage fluctuation/flicker measurement ON/OFF, nominal voltage setting, existing rated voltage, relative steady-state voltage change ON/OFF, limit for relative steady-state voltage change, maximum relative voltage change ON/OFF, limit for maximum relative voltage change, duration during which voltage exceeds the threshold level within one voltage change ON/OFF, limit for duration during which voltage exceeds the threshold level within one voltage change, short-term flicker value ON/OFF, limit for short-term flicker value, long-term flicker value ON/OFF, limit for long-term flicker value, constant used in the equation, observation period for short-term flicker value, number of times measurement is performed, steady-state range, and input elements</b> |
| Un Setting Mode Auto     |   |   |
| Un Setting Volt 230.00V  |   |   |
| dc 3.00% On              |   |   |
| dmax 4.00% On            |   |   |
| d(t) 3.00%, 200ms On     |   |   |
| Pst 1.00 On              |   |   |
| Plt 0.65 On              |   |   |
| Plt N Value 12           |   |   |
| Pst Interval 10m00s      |   |   |
| Pst Measuring Count 12   |   |   |
| dmin 0.10 %              |   |   |
| Flicker Element 1 On     |   |   |
| Flicker Element 2 Off    |   |   |
| Flicker Element 3 Off    |   |   |
| Communication Command 3  |   | <b>Command group used</b>   |

This can be printed only when the option is installed

### Output Items for Normal Measurement

The following example shows output items when "RL" is selected for the built-in printer output type. The number to the right of each output item indicates the element no.

|                    |        |            |              |          |             |                             |
|--------------------|--------|------------|--------------|----------|-------------|-----------------------------|
|                    | Normal | 1996.07.31 | Integration  | Integral | 1996.07.31  |                             |
|                    | Manual | 14:57:23   | Manual       | Manual   | 14:56:43    |                             |
| Normal measurement |        |            | Manual print |          |             | Print date/time             |
| Manual print       |        |            |              |          |             |                             |
|                    | U 1    | 15.006     | Urms         | U 1      | -----       |                             |
|                    | A 1    | 2.9814     | Arms         | A 1      | -----       |                             |
|                    | W 1    | 23.84      | W            | W 1      | 23.84 W     |                             |
|                    | UA 1   | 44.74      | UA           | UA 1     | -----       |                             |
|                    | Var 1  | 37.85      | var          | Var 1    | -----       |                             |
|                    | PF 1   | 0.5330     |              | PF 1     | -----       |                             |
|                    | DEG 1  | 57.79      |              | DEG 1    | -----       |                             |
|                    | Upk 1  | - 21.24    | U            | Upk 1    | -----       |                             |
|                    | Apk 1  | - 4.229    | A            | Apk 1    | -----       |                             |
|                    | HM 1   | 000:00:00  |              | HM 1     | 000:08:44   | Elapsed time of integration |
|                    | Wh 1   | -----      |              | Wh 1     | 3.4700 Wh   | Watt-hour                   |
|                    | Wh+ 1  | -----      |              | Wh+ 1    | 4.1080 Wh   | Positive watt-hour          |
|                    | Wh- 1  | -----      |              | Wh- 1    | - 0.6379 Wh | Negative watt-hour          |
|                    | Ah 1   | -----      |              | Ah 1     | 433.92 mAh  | Ampere-hour                 |
|                    | Ah+ 1  | -----      |              | Ah+ 1    | 433.92 mAh  | Positive ampere-hour        |
|                    | Ah- 1  | -----      |              | Ah- 1    | 0.00 mAh    | Negative ampere-hour        |
|                    | U 2    | 15.003     | Urms         | U 2      | -----       |                             |
|                    | A 2    | 2.9812     | Arms         | A 2      | -----       |                             |
|                    | W 2    | 23.84      | W            | W 2      | 23.83 W     |                             |
|                    | UA 2   | 44.73      | UA           | UA 2     | -----       |                             |
|                    | Var 2  | 37.85      | var          | Var 2    | -----       |                             |
|                    | PF 2   | 0.5330     |              | PF 2     | -----       |                             |
|                    | DEG 2  | 57.79      |              | DEG 2    | -----       |                             |
|                    | Upk 2  | - 21.25    | U            | Upk 2    | -----       |                             |
|                    | Apk 2  | - 4.228    | A            | Apk 2    | -----       |                             |
|                    | HM 2   | 000:00:00  |              | HM 2     | 000:08:44   |                             |
|                    | Wh 2   | -----      |              | Wh 2     | 3.4692 Wh   |                             |
|                    | Wh+ 2  | -----      |              | Wh+ 2    | 4.1070 Wh   |                             |
|                    | Wh- 2  | -----      |              | Wh- 2    | - 0.6379 Wh |                             |
|                    | Ah 2   | -----      |              | Ah 2     | 433.90 mAh  |                             |
|                    | Ah+ 2  | -----      |              | Ah+ 2    | 433.90 mAh  |                             |
|                    | Ah- 2  | -----      |              | Ah- 2    | 0.00 mAh    |                             |
|                    | U 3    | 14.998     | Urms         | U 3      | -----       |                             |
|                    | A 3    | 2.9811     | Arms         | A 3      | -----       |                             |
|                    | W 3    | 23.83      | W            | W 3      | 23.83 W     |                             |
|                    | UA 3   | 44.71      | UA           | UA 3     | -----       |                             |
|                    | Var 3  | 37.83      | var          | Var 3    | -----       |                             |
|                    | PF 3   | 0.5330     |              | PF 3     | -----       |                             |
|                    | DEG 3  | 57.79      |              | DEG 3    | -----       |                             |
|                    | Upk 3  | - 21.23    | U            | Upk 3    | -----       |                             |
|                    | Apk 3  | - 4.226    | A            | Apk 3    | -----       |                             |
|                    | HM 3   | 000:00:00  |              | HM 3     | 000:08:44   |                             |
|                    | Wh 3   | -----      |              | Wh 3     | 3.4680 Wh   |                             |
|                    | Wh+ 3  | -----      |              | Wh+ 3    | 4.1056 Wh   |                             |
|                    | Wh- 3  | -----      |              | Wh- 3    | - 0.6376 Wh |                             |
|                    | Ah 3   | -----      |              | Ah 3     | 433.88 mAh  |                             |
|                    | Ah+ 3  | -----      |              | Ah+ 3    | 433.88 mAh  |                             |
|                    | Ah- 3  | -----      |              | Ah- 3    | 0.00 mAh    |                             |
|                    | U      | 15.002     | Urms         | U        | -----       |                             |
|                    | A      | 2.9812     | Arms         | A        | -----       |                             |
|                    | W      | 71.51      | W            | W        | 71.50 W     |                             |
|                    | UA     | 134.18     | UA           | UA       | -----       |                             |
|                    | Var    | 113.53     | var          | Var      | -----       |                             |
|                    | PF     | 0.5330     |              | PF       | -----       |                             |
|                    | DEG    | 57.79      |              | DEG      | -----       |                             |
|                    | HM     | 000:00:00  |              | HM       | 000:08:44   |                             |
|                    | Wh     | -----      |              | Wh       | 10.4072 Wh  |                             |
|                    | Wh+    | -----      |              | Wh+      | 12.3206 Wh  |                             |
|                    | Wh-    | -----      |              | Wh-      | - 1.9134 Wh |                             |
|                    | Ah     | -----      |              | Ah       | 1.30170 Ah  |                             |
|                    | Ah+    | -----      |              | Ah+      | 1.30170 Ah  |                             |
|                    | Ah-    | -----      |              | Ah-      | 0.00000 Ah  |                             |
|                    | HzA 1  | 59.999     | Hz           | HzA 1    | 59.999      |                             |
|                    | CU1    | 1.416      |              | CU1      | -----       |                             |

### Print Examples for Harmonic Analysis

Output item:  $I$  (current)  
 Element 1  
 (Measured current and distortion are printed in numeric.)

Output item:  $I - R$  (current in graph)  
 Element 1  
 (Measured current is printed in graph.)

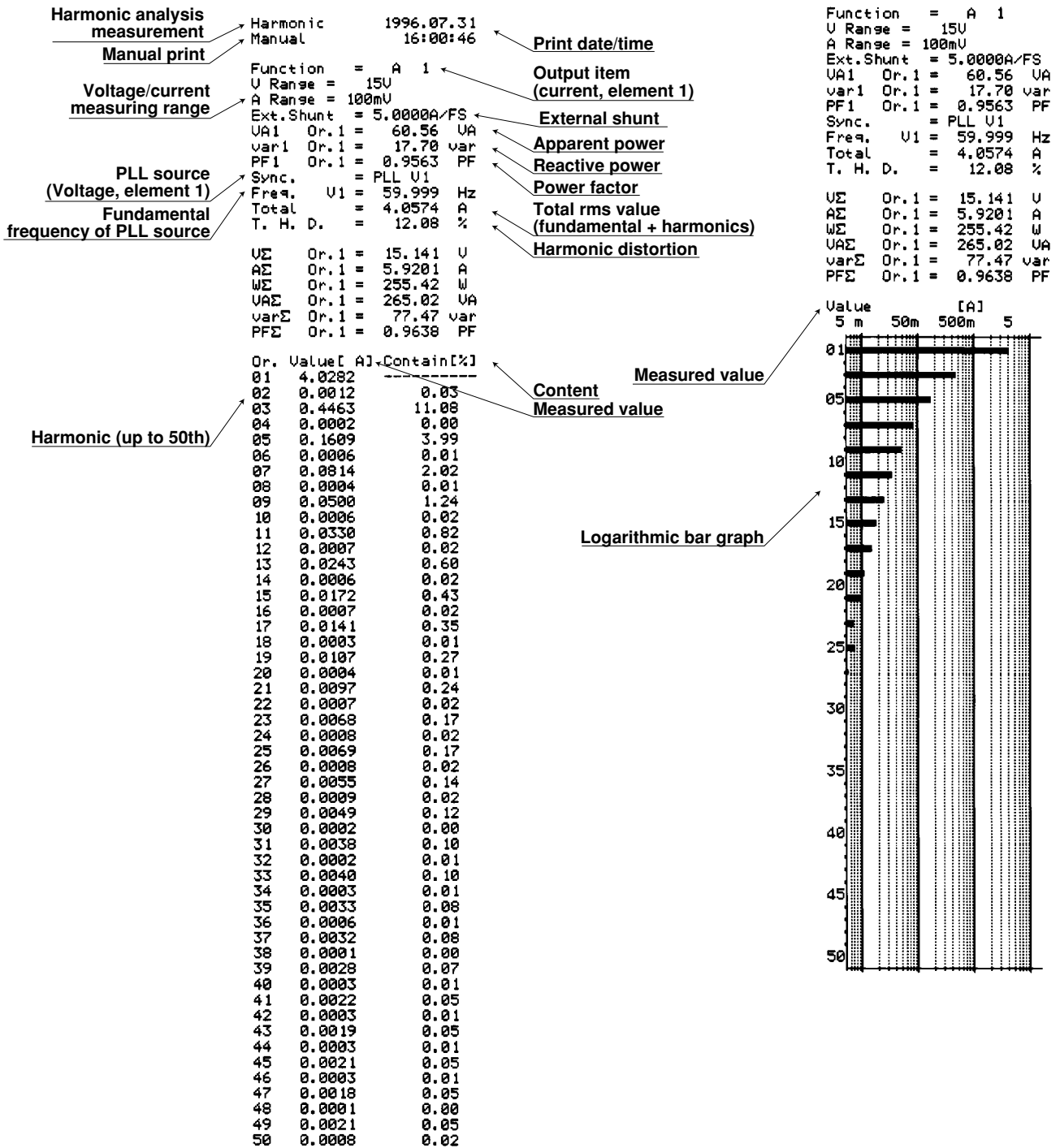

Output item:  $\bar{U} - P$  (active power in graph)  
 Element 1 (Measured active power is printed in graph.)

Harmonic 1996.07.31  
 Manual 16:09:27

Function = W 1  
 U Range = 15U  
 A Range = 100mU  
 Ext.Shunt = 5.0000A/FS  
 VA1 Or.1 = 35.97 VA  
 var1 Or.1 = 18.56 var  
 PF1 Or.1 = 0.8567 PF  
 Sync. = PLL U1  
 Freq. U1 = 59.999 Hz  
 Total = 29.08 W  
  
 UΣ Or.1 = 15.171 U  
 AΣ Or.1 = 4.2297 A  
 WΣ Or.1 = 127.22 W  
 VAΣ Or.1 = 157.37 VA  
 varΣ Or.1 = 81.18 var  
 PFE Or.1 = 0.8084 PF

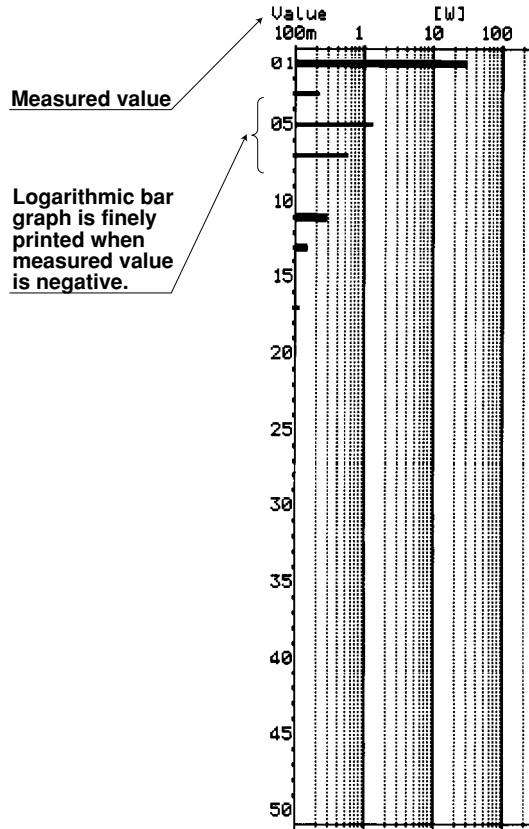

Output item:  $\angle E \angle$  (phase angle)  
 Element 1 (Phase angle is printed in numeric.)

Output item:  $\angle - \angle \angle$  (phase angle of voltage)  
 Element 1 (Phase angle of higher harmonic in relation to the fundamental of voltage is printed in graph.)

```

Harmonic      1996.07.31
Manual        16:07:24

Function      = DEG1
U Range      = 15U
A Range      = 100mU
Ext.Shunt    = 5.0000A/FS
UA1 Or.1    = 14.56 UA
var1 Or.1   = 7.50 var
PF1 Or.1    = 0.8571 PF
des1 Or.1   = 31.00 des
Sync.       = PLL U1
Freq. U1    = 60.000 Hz
Fundamental=G 31.00 des

UΣ Or.1    = 8.787 U
AΣ Or.1    = 2.4523 A
WΣ Or.1    = 54.46 W
UAE Or.1   = 63.72 UA
varΣ Or.1  = 32.82 var
PFE Or.1   = 0.8548 PF
    
```

Output item (phase angle, element 1)

Output item (phase angle of voltage, element 1)

Phase angle between fundamentals of voltage and current

Phase angle of each harmonic in relation of fundamental of voltage

| Or. | U [deg] | A [deg] |
|-----|---------|---------|
| 02  | 89.48   | 98.88   |
| 03  | -179.98 | 179.90  |
| 04  | 129.89  | 94.58   |
| 05  | 0.04    | 0.12    |
| 06  | -58.36  | 78.96   |
| 07  | -179.94 | -179.52 |
| 08  | 89.93   | 82.76   |
| 09  | 0.08    | -1.08   |
| 10  | -46.84  | 67.84   |
| 11  | -179.89 | -179.35 |
| 12  | -5.13   | -99.68  |
| 13  | 0.10    | -0.56   |
| 14  | 54.49   | -93.34  |
| 15  | -179.71 | -176.69 |
| 16  | 68.94   | 141.14  |
| 17  | 0.20    | -0.35   |
| 18  | 64.83   | -99.18  |
| 19  | -179.64 | -176.57 |
| 20  | -78.70  | 84.14   |
| 21  | 0.21    | 2.19    |
| 22  | 66.55   | 92.12   |
| 23  | -179.85 | 179.11  |
| 24  | -124.41 | -111.74 |
| 25  | 0.41    | -2.33   |
| 26  | 6.07    | 66.84   |
| 27  | 179.92  | 171.28  |
| 28  | 59.35   | -157.88 |
| 29  | 1.12    | -18.12  |
| 30  | 70.68   | -6.95   |
| 31  | 177.74  | -176.52 |
| 32  | -63.26  | 82.74   |
| 33  | 0.87    | -22.78  |
| 34  | 162.16  | -137.02 |
| 35  | 179.91  | -154.79 |
| 36  | 179.27  | -51.94  |
| 37  | 0.44    | -7.77   |
| 38  | 19.39   | 21.91   |
| 39  | 178.58  | -178.03 |
| 40  | -117.22 | 62.56   |
| 41  | 0.03    | -19.18  |
| 42  | -103.39 | 61.66   |
| 43  | 178.31  | 159.91  |
| 44  | 95.09   | -30.20  |
| 45  | -2.08   | -2.51   |
| 46  | 89.69   | -155.21 |
| 47  | 178.26  | -169.28 |
| 48  | -126.41 | -59.01  |
| 49  | -3.80   | 13.28   |
| 50  | 122.36  | -68.81  |

Phase angle of each harmonic in relation of fundamental of current

deg (bar graph)

```

Function      = U des1
U Range      = 15U
A Range      = 100mU
Ext.Shunt    = 5.0000A/FS
UA1 Or.1    = 14.56 UA
var1 Or.1   = 7.50 var
PF1 Or.1    = 0.8571 PF
des Or.1    = 31.00 des
Sync.       = PLL U1
Freq. U1    = 60.000 Hz
Fundamental=G 31.00 des

UΣ Or.1    = 8.787 U
AΣ Or.1    = 2.4523 A
WΣ Or.1    = 54.46 W
UAE Or.1   = 63.72 UA
varΣ Or.1  = 32.82 var
PFE Or.1   = 0.8548 PF
    
```

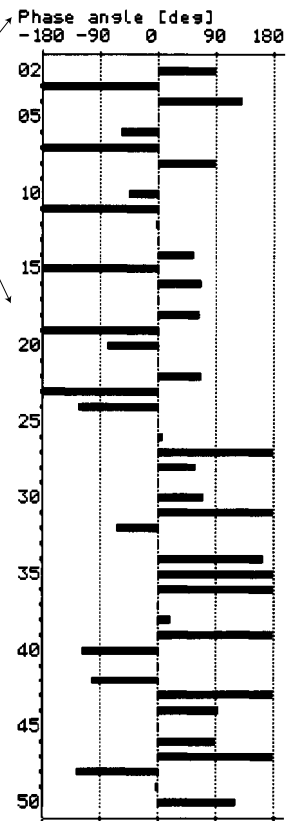

Print Examples for Voltage Fluctuation/Flicker Measurement

Output item:  $\overline{P F}$  (Cumulative probability function graph)

Output item:  $\overline{U U d U}$  (Flicker meter judgment result table)

Flicker 1996.01.01  
Manual 07:02:40

#####  
Element 1 Period = 2  
#####  
U Range = 300V  
Un U1 = 234.19 V  
Freq. U1 = 49.999 Hz  
Pst Interval = 10m00s  
Elapsed Time = 00h20m00s

dc Lmt= 3.00%  
dmax Lmt= 4.00%  
d(t) Lmt= 3.00%, 200ms  
Pst Lmt= 1.00

dc = 2.91% Pass  
dmax = 2.96% Pass  
d(t) = 0ms Pass  
Pst = 2.02 Fail

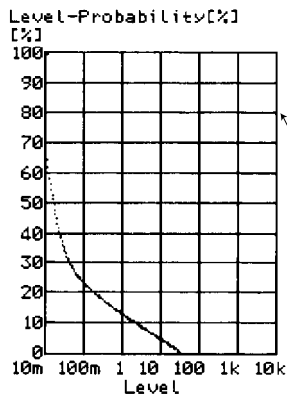

Voltage range  
Nominal voltage Un  
Frequency of input voltage Un  
Measurement time for short-term flicker value Pst  
Elapsed time  
Limit for each parameter  
Measurement data for dc, dmax, d(t)<sub>200ms</sub> and Pst, with judgment result  
Pass: Judgment conditions were satisfied.  
Fail: Judgment conditions were not satisfied.  
Error: Judgment not possible.

Cumulative probability function graph

#####  
Element 1 Period = 12  
#####  
U Range = 300 V  
Un U1 = 230.00 V  
Freq. U1 = 50.000 Hz  
Pst Interval = 10m00s  
Elapsed Time = 02h00m00s

| ##### | dc [%] | #####    |
|-------|--------|----------|
| Lmt=  | 3.00   |          |
| No.   | dc [%] | Judgment |
| 1     | 2.21   | Pass     |
| 2     | 2.33   | Pass     |
| 3     | 2.45   | Pass     |
| 4     | 2.57   | Pass     |
| 5     | 2.49   | Pass     |
| 6     | 2.31   | Pass     |
| 7     | 2.56   | Pass     |
| 8     | 2.64   | Pass     |
| 9     | 2.41   | Pass     |
| 10    | 2.37   | Pass     |
| 11    | 2.25   | Pass     |
| 12    | 2.39   | Pass     |

#####

| ##### | dmax [%] | #####    |
|-------|----------|----------|
| Lmt=  | 4.00     |          |
| No.   | dmax [%] | Judgment |
| 1     | 3.02     | Pass     |
| 2     | 3.68     | Pass     |
| 3     | 3.32     | Pass     |
| 4     | 3.18     | Pass     |
| 5     | 3.37     | Pass     |
| 6     | 3.65     | Pass     |
| 7     | 3.76     | Pass     |
| 8     | 3.51     | Pass     |
| 9     | 3.14     | Pass     |
| 10    | 3.58     | Pass     |
| 11    | 3.41     | Pass     |
| 12    | 3.27     | Pass     |

| ##### | d(t) [ms] | #####    |
|-------|-----------|----------|
| Lmt=  | 200       |          |
| No.   | d(t) [ms] | Judgment |
| 1     | 0         | Pass     |
| 2     | 0         | Pass     |
| 3     | 10        | Pass     |
| 4     | 20        | Pass     |
| 5     | 0         | Pass     |
| 6     | 50        | Pass     |
| 7     | 0         | Pass     |
| 8     | 0         | Pass     |
| 9     | 10        | Pass     |
| 10    | 0         | Pass     |
| 11    | 0         | Pass     |
| 12    | 10        | Pass     |

| ##### | Pst  | #####    |
|-------|------|----------|
| Lmt=  | 1.00 |          |
| No.   | Pst  | Judgment |
| 1     | 0.85 | Pass     |
| 2     | 0.86 | Pass     |
| 3     | 0.90 | Pass     |
| 4     | 0.93 | Pass     |
| 5     | 0.87 | Pass     |
| 6     | 0.98 | Pass     |
| 7     | 0.99 | Pass     |
| 8     | 0.88 | Pass     |
| 9     | 0.94 | Pass     |
| 10    | 0.95 | Pass     |
| 11    | 0.92 | Pass     |
| 12    | 0.91 | Pass     |

#####  
Lmt= 0.65  
Plt= 0.92 Fail  
#####  
Total Judge Fail  
#####

# Index

| <b>A</b>                         | <b>Page</b>   |
|----------------------------------|---------------|
| ABORT key .....                  | 1-5, 11-10    |
| Accessories .....                | 3             |
| Accuracy .....                   | 3-13, 16-1    |
| Active power .....               | 4-6, 5-1, 9-9 |
| Address setting .....            | 14-6          |
| Addressable mode .....           | 14-4, 14-6    |
| Analog signals .....             | 12-4          |
| ANALYZE key .....                | 1-5, 9-1      |
| Anti-aliasing filter .....       | 9-4           |
| Apparent power .....             | 4-6, 5-3, 9-9 |
| Arithmetic operations .....      | 7-4           |
| AUTO key (auto-print mode) ..... | 11-8, 11-10   |
| AUTO key (auto-range) .....      | 4-4, 4-5      |
| Auto range setting .....         | 4-5           |
| Auto-print .....                 | 11-8          |
| Averaging functions .....        | 7-9           |
| Averaging samples .....          | 7-9           |
| AVG key .....                    | 1-5, 7-9      |

| <b>B</b>              | <b>Page</b>  |
|-----------------------|--------------|
| Backup function ..... | 13-4         |
| Baud rate .....       | 14-10, 14-12 |

| <b>C</b>                                       | <b>Page</b>                |
|--|----------------------------|
| Calibration .....                              | 15-1                       |
| CCITT standard .....                           | 14-9                       |
| Command list .....                             | App1-1, App2-9             |
| Commands .....                                 | Appendix 1, Appendix 2     |
| Common-mode voltage .....                      | 3-6                        |
| Communication functions .....                  | 14-4, 14-7                 |
| Communication output items, selection of ..... | 14-1                       |
| Computation overflow .....                     | 1-4                        |
| Computing equations .....                      | 3-15, 7-2, 8-4, 9-10, 9-11 |
| Computing functions .....                      | 1-2                        |
| Connectors .....                               | 2, 1-6, 3-10, 12-1         |
| Continuous integration mode .....              | 8-2, 8-8                   |
| Corrective actions (troubleshooting) .....     | 15-1                       |
| Crest factor .....                             | 7-3                        |
| CSA .....                                      | 9-11                       |
| CT ratio .....                                 | 7-7                        |
| Current input terminal .....                   | 1-6                        |
| Current integration .....                      | 8-4, 8-7                   |
| Cutoff frequency (anti-aliasing filter) .....  | 9-4                        |
| Cutoff frequency (general operation) .....     | 4-1                        |

| <b>D</b>                             | <b>Page</b>  |
|--------------------------------------|--------------|
| D/A .....                            | 12-1, 12-4   |
| Data format, in communications ..... | 14-10, 14-11 |
| Data output format .....             | App1-17      |
| Data .....                           | App2-6       |
| DC key .....                         | 1-5, 4-3     |
| Default settings .....               | 2-6          |
| Device Clear function .....          | 14-5         |
| Digital displays .....               | 4-9          |

|                            |                          |
|----------------------------|--------------------------|
| Display functions .....    | 16-4                     |
| Display resolution .....   | 4-6, 7-1, 8-7            |
| Display type .....         | 9-3                      |
| Display update cycle ..... | 4-2, 6-1, 8-4, 9-8       |
| Displays .....             | 4-9, 4-10, 7-4, 9-7, 9-8 |
| DSP .....                  | 1-1                      |

| <b>E</b>                                | <b>Page</b>                   |
|---|-------------------------------|
| Efficiency .....                        | 3-15, 7-1                     |
| Elapsed time of integration .....       | 8-7, 8-11                     |
| ELEMENT key .....                       | 1-5, 3-3, 9-6, 10-14 to 10-16 |
| Element no. ....                        | 4-4                           |
| Error codes .....                       | 15-2, 15-3, App2-67           |
| Error queue .....                       | App2-60                       |
| Exponential averaging .....             | 7-9                           |
| Extended event register .....           | App2-8, App2-59               |
| External current transform (CT) .....   | 3-1, 3-8, 7-7                 |
| External dimensions .....               | 16-4                          |
| External input/output connector .....   | 1-6, 12-1                     |
| External potential transform (PT) ..... | 3-8, 7-7                      |
| External sample clock .....             | 9-5                           |
| External sensor range .....             | 4-7                           |
| External shunt .....                    | 3-10, 3-11                    |
| External-shunt output value .....       | 4-8                           |

| <b>F</b>                                     | <b>Page</b>                         |
|--|-------------------------------------|
| FEED key .....                               | 1-5, 11-1                           |
| Files .....                                  | 13-1                                |
| FLICKER key .....                            | 1-5, 10-2, 10-3                     |
| Fluctuation/flicker measurement .....        | Chapter 10                          |
| Frequency filter (general measurement) ..... | 6-1                                 |
| Frequency filter (harmonic analysis) .....   | 9-5                                 |
| Frequency measurement .....                  | 1-2, 4-2                            |
| Frequency measurement .....                  | 6-1                                 |
| Front panel .....                            | 1-5                                 |
| Function grounding terminal .....            | 4, 1-6                              |
| FUNCTION key .....                           | 1-5, 4-9, 4-10, 9-6, 10-14 to 10-16 |
| Functional Block Diagram .....               | 1-1                                 |
| Fundamental + higher harmonics .....         | 9-10                                |
| Fundamental frequency .....                  | 9-14                                |
| Fundamentals .....                           | 9-9                                 |
| Fuse holder .....                            | 15-4                                |
| Fuse .....                                   | 3, 4, 15-4                          |

| <b>G</b>              | <b>Page</b> |
|-----------------------|-------------|
| GP-IB interface ..... | 2, 14-4     |
| Groups .....          | App2-4      |

| <b>H</b>                  | <b>Page</b>    |
|---------------------------|----------------|
| Handshaking .....         | 14-10          |
| Harmonic distortion ..... | 9-11           |
| Harmonic order .....      | 9-3            |
| Harmonics analysis .....  | Chapter 9      |
| Header .....              | App2-3, App2-5 |

## Index

|                |                            |
|----------------|----------------------------|
| HOLD key ..... | 1-5, 4-2                   |
| HOLD .....     | 1-3, 4-2, 8-11, 8-12, 12-2 |

| I                              | Page                |
|--------------------------------|---------------------|
| IEC .....                      | 9-11                |
| IEEE4882-1987 standard .....   | 14-6, 14-12, App2-1 |
| Impedance .....                | 3-14                |
| Initialization .....           | 13-2                |
| INITIAL key .....              | 1-5, 10-1 to 10-3   |
| Input elements .....           | 3-3                 |
| Input signal .....             | 4-3, 6-1            |
| Input/output signals .....     | 1-3, 12-1, 12-2     |
| Installation conditions .....  | 2-2                 |
| Installation position .....    | 2-3                 |
| Integrated power .....         | 8-11                |
| Integrated value .....         | 8-1, 8-7, 8-11      |
| Integration elapsed time ..... | 8-7, 8-11           |
| Integration modes .....        | 8-1, 8-8            |
| Integration overflow .....     | 8-11                |
| Integration timer .....        | 8-1, 8-3, 8-6, 8-8  |
| Integrator functions .....     | 8-1                 |
| Interface modes .....          | 14-4, 14-7          |
| INTERFACE .....                | 1-5, 14-4, 14-7     |
| Interval .....                 | 11-9                |

| K              | Page |
|----------------|------|
| Key lock ..... | 13-3 |

| L                       | Page                     |
|-------------------------|--------------------------|
| Lead wires .....        | 3-1                      |
| LIMIT key .....         | 1-5, 10-2, 10-4 to 10-13 |
| LINE FILTER key .....   | 1-5, 4-1                 |
| Line filter .....       | 4-1                      |
| List printout .....     | 11-6                     |
| Listener function ..... | 14-4                     |
| LOCAL key .....         | 1-5, 14-4                |
| Local mode .....        | 14-5                     |

| M                              | Page                        |
|--------------------------------|-----------------------------|
| Manual integration mode .....  | 8-1, 8-8                    |
| Manual print .....             | 11-7                        |
| Manual range setting .....     | 4-5                         |
| Math functions .....           | 3-15, 7-3, 7-4              |
| Maximum analysis order .....   | 16-2                        |
| Maximum integrated value ..... | 8-1, 8-11                   |
| Maximum integration time ..... | 8-1                         |
| MEAN key .....                 | 4-3                         |
| Measurement modes .....        | 4-2, 4-3, 8-4, 8-7          |
| Measurement range .....        | 4-5 to 4-8                  |
| Message units .....            | App2-2                      |
| Messages .....                 | App2-2                      |
| MISC key .....                 | 2-8, 12-4, 12-8, 13-1, 13-2 |
| MODE key .....                 | 1-5, 8-8                    |
| Model names .....              | 2                           |
| Moving average .....           | 7-9                         |

| N              | Page      |
|----------------|-----------|
| NULL key ..... | 1-5, 7-11 |

| O                      | Page                           |
|------------------------|--------------------------------|
| Opening messages ..... | 2-7                            |
| Output channel .....   | 12-4                           |
| Output format .....    | 11-2, 12-4                     |
| Output format .....    | 11-2, 12-4, 14-1               |
| Output function .....  | 11-2, 12-4, 14-1, 14-2         |
| Output items .....     | 11-2 to 11-4, 12-5, 14-1, 14-3 |
| Output queue .....     | App2-60                        |
| Over range .....       | 1-4                            |

| P                                   | Page            |
|-------------------------------------|-----------------|
| Peak current .....                  | 1-4, 5-2        |
| PEAKHOLD key .....                  | 1-5, 5-2        |
| Peak overflow .....                 | 1-4             |
| Peak value .....                    | 5-2             |
| Peak voltage .....                  | 1-4, 5-2        |
| Phase angle .....                   | 5-6, 9-12, 9-13 |
| Phase lag .....                     | 5-6, 5-7        |
| Phase lead .....                    | 5-6, 5-7        |
| PLL source .....                    | 9-2             |
| Power connector .....               | 1-6             |
| Power cord .....                    | 2, 4, 2-4       |
| Power factor .....                  | 5-5             |
| Power fuse .....                    | 2-4, 15-4       |
| Power integration .....             | 8-4             |
| Power range .....                   | 4-6             |
| POWER switch .....                  | 1-5, 2-5        |
| Print Examples .....                | Appendix 3      |
| Print examples .....                | Appendix 3      |
| Print interval .....                | 11-8 to 11-10   |
| PRINT key .....                     | 1-5, 11-7       |
| Printer .....                       | 2, 11-1, 11-2   |
| Protective grounding terminal ..... | 4-, 2-4         |
| PT ratio .....                      | 7-7             |

| Q             | Page           |
|---------------|----------------|
| Queries ..... | App2-2, App2-5 |

| R   | Page          |
|---|---------------|
| Rack mount .....                                    | 2-3, 3-1      |
| Rack-mount installation .....                       | 16-4          |
| Range setting keys .....                            | 4-4           |
| RATE key .....                                      | 1-5, 4-2, 6-1 |
| Rated integration time .....                        | 12-8          |
| Reactive power .....                                | 4-6, 5-4, 9-9 |
| Realtime-counting continuous integration mode ..... | 8-3, 8-9      |
| Realtime-counting standard integration mode .....   | 8-3, 8-9      |
| Rear panel .....                                    | 1-6           |
| Relative harmonic content .....                     | 9-9           |
| Remote control .....                                | 12-1 to 12-3  |
| Remote mode .....                                   | 14-5          |
| Repeat integration .....                            | 8-2, 8-3      |
| RESET key .....                                     | 8-10 to 8-13  |



|                               |         |
|-------------------------------|---------|
| RMS key .....                 | 4-2     |
| Roll chart, for printer ..... | 3, 11-1 |
| RS-232-C interface .....      | 2, 14-7 |

**S****Page**

|  |   |
|--|---|
| Sample programs .....                    | <b>App1-34, App2-61</b>                     |
| Sample rate (display update cycle) ..... | 4-2, 6-1, 8-4, 9-8                          |
| SAMPLE RATE key .....                    | 1-5, 4-2, 6-1                               |
| SCALING FACTOR .....                     | 7-7   |
| Scaling factor .....                     | 7-7   |
| Scaling function .....                   | 7-7   |
| Scaling values .....                     | 7-7   |
| SET UP key (auto-print mode) .....       | 1-5, 11-2, 11-6, 11-8                       |
| SET UP key (harmonic analysis) .....     | 1-5, 9-2 to 9-4                             |
| Setup information, backing up .....      | 13-4  |
| Setup information, initializing .....    | 13-2  |
| Setup information, loading .....         | 13-2  |
| Setup information, saving .....          | 13-1  |
| SHIFT key .....                          | 1-5   |
| Shunt .....                              | 3-10 to 3-12                                |
| Signal wiring example .....              | 14-9  |
| Single-phase three-wire .....            | 3-4, 3-8, 3-12                              |
| Single-phase two-wire .....              | 3-4, 3-8, 3-12                              |
| Specifications .....                     | <b>Chapter 16</b>                           |
| Standard event register .....            | <b>App2-58</b>                              |
| Standard integration mode .....          | 8-2, 8-8                                    |
| Start bit .....                          | 14-11                                       |
| START .....                              | 1-5, 8-1, 8-10                              |
| START/STOP key .....                     | 1-5, 10-2, 10-3, 10-14, 10-15, 10-17, 10-18 |
| Status-byte format .....                 | <b>App1-17, App2-57</b>                     |
| Stop bit(s) .....                        | 14-11                                       |
| STOP .....                               | 1-5, 8-1, 8-11                              |
| Storage location .....                   | 2-1   |
| Suffix code .....                        | 2   |
| SUM, +, - key .....                      | 1-5, 8-10                                   |

**T****Page**

|                                   |                      |
|-----------------------------------|----------------------|
| Talk-only .....                   | 14-4                 |
| Talker function .....             | 14-4                 |
| Terminator .....                  | 14-6                 |
| Three-phase four-wire .....       | 3-5, 3-9, 3-12       |
| Three-phase three-wire .....      | 3-5, 3-9, 3-12       |
| Three-voltage three-current ..... | 3-5, 3-9             |
| Timer .....                       | 8-2, 8-8             |
| TRIG key .....                    | 1-5, 4-2, 8-11, 8-12 |
| Trigger .....                     | 4-2, 12-1            |
| Two-prong outlet .....            | 2-1                  |

**U****Page**

|   |     |
|---|-----|
| Upper limit of the harmonic order ..... | 9-4 |
|---|-----|

**V****Page**

|                              |     |
|------------------------------|-----|
| Voltage input terminal ..... | 1-6 |
|------------------------------|-----|

**W****Page**

|                               |                |
|-------------------------------|----------------|
| WIRING key .....              | 1-5, 3-2, 8-10 |
| Wiring system .....           | 3-2, 3-4, 10-1 |
| Wiring-system selection ..... | 3-2            |